



ET-2251
PET-2251

ET-2251-32
PET-2251-32

(PoE) Ethernet I/O Module with 16/32-ch DI

Features

- Built-in Web Server
- Support Modbus TCP/UDP, MQTT, and SNMP V2c Protocols
- 2-port Ethernet Switch (LAN Bypass) for Daisy-Chain Wiring
- Dual Watchdog
- I/O Pair Connection (Push and Pull)
- Built-in I/O
 - (P)ET-2251: 16-channel Wet contact & Dry contact DI
 - (P)ET-2251-32: 32-channel Wet contact & Dry contact DI
- LED Display to Indicate the I/O Status



Introduction

The (P)ET-2251/(P)ET-2251-32 provides 16/32 wet contact and dry contact Digital Input channels. With 2 Ethernet ports, the (P)ET-2251/(P)ET-2251-32 allows daisy chain connection which permits the flexibility in locating devices, eases installation and lowers infrastructure costs. It features 8 kV ESD protection, 4 kV EFT protection, 3 kV surge, and 3000 VDC I/O isolation to enhance noise protection capabilities in industrial environments. Each input channel can be used as a 32-bit counter.

System Specifications

Model	ET-2251	ET-2251-32	PET-2251	PET-2251-32
Software				
Built-in Web Server	Yes			
CPU Module				
CPU	32-bit ARM			
Watchdog Timer	Module, Communication (Programmable)			
Isolation				
2-way Isolation	Ethernet: 1500 VDC, I/O: 3000 VDC		I/O: 3000 VDC	
EMS Protection				
EFT (IEC 61000-4-4)	±4 kV for Power Line			
ESD (IEC 61000-4-2)	(P)ET-2251: ±8 kV Contact for Each Terminal, ±16 kV Air for Random Point (P)ET-2251-32: ±4 kV Contact for Each Terminal, ±8 kV Air for Random Point			
Surge (IEC 61000-4-5)	±2 kV for Power Line			
LED Indicators				
Status	Run, Ethernet, I/O		Run, Ethernet, I/O, PoE	
Ethernet				
Ports	2 x RJ-45, 10/100 Base-Tx, Switch Ports			
PoE	-		Yes	
LAN bypass	Yes			
Security	Password and IP Filter			
Protocol	Modbus TCP, Modbus UDP, MQTT, and SNMP V2c			
Power				
Reverse Polarity Protection	Yes			
Consumption	3.0 W (max.)	3.8 W (max.)	3.6 W (max.)	3.9 W (max.)
Powered from PoE	-		IEEE 802.3af, Class1	IEEE 802.3af, Class2
Powered from Terminal Block	+10 to +30 VDC		+10 to +48 VDC	
Mechanical				
Casing	Plastic			
Dimensions (mm)	(P)ET-2251: 33 x 126 x 108 (W x L x H), (P)ET-2251-32: 31 x 157 x 126 (W x L x H)			
Installation	DIN-Rail Mounting			
Environment				
Operating Temperature	-25 to +75°C			
Storage Temperature	-40 to +80°C			
Humidity	10 to 90% RH, Non-condensing			

I/O Specifications

Model	(P)ET-2251	(P)ET-2251-32
Digital Input/Counter		
Channels	16	32
Type	Dry Contact Wet Contact	
Sink/Source (NPN/PNP)	Dry: Source Wet: Sink/Source	
ON Voltage Level	Dry: Close to GND Wet: +5 to +50 VDC	
OFF Voltage Level	Dry: Open Wet: +1 VDC (max.)	
Max. Counts	4,294,967,295 (32-bit)	
Frequency	3 kHz	2.5 kHz
Input Impedance	7.5 kΩ	
Overvoltage Protection	+ 70 VDC	
Low Pass Filter	1 to 6500 ms (0.08 Hz to 500 Hz)	

Wire Connections

Digital Input /Counter	Readback as 1	Readback as 0	Digital Input /Counter	Readback as 1	Readback as 0
Wet Contact (Sink)	+5 to +50 VDC	OPEN or <1 VDC	Dry Contact	Close to GND	Open
Wet Contact (Source)	+5 to +50 VDC	OPEN or <1 VDC			

Pin Assignments

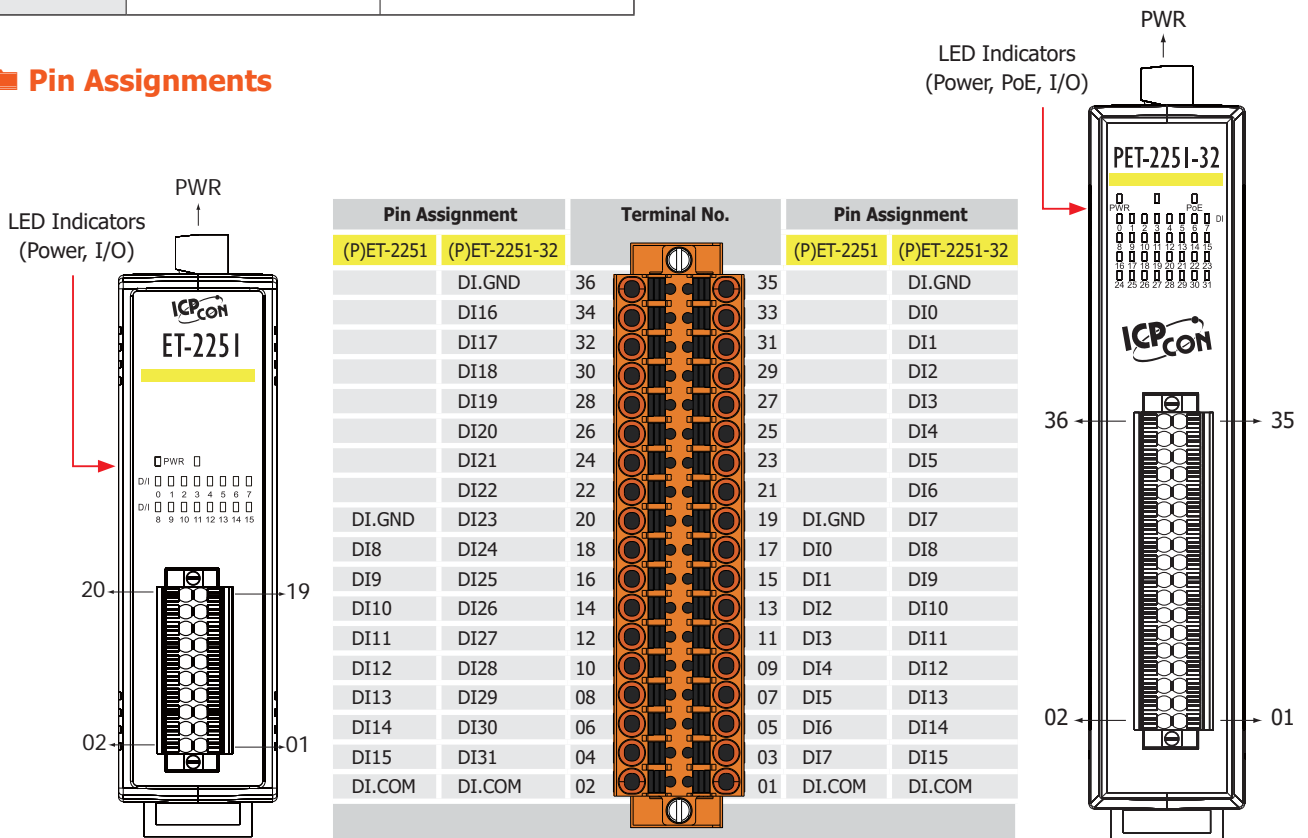

Appearance

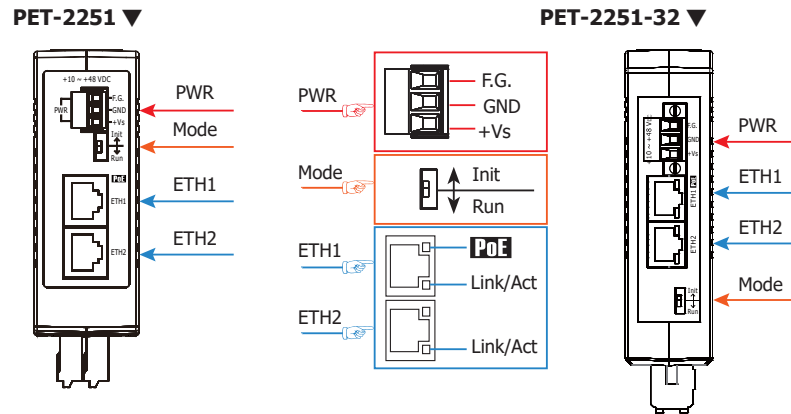

Dimensions (Units: mm)

(P)ET-2251

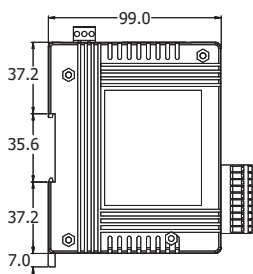

Left Side View

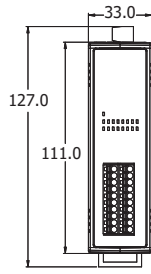

Front View

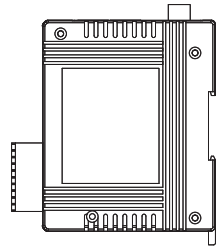

Right Side View

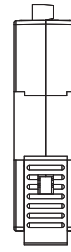

Rear View

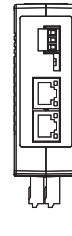

Top View

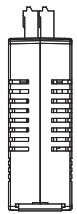

Bottom View

(P)ET-2251-32

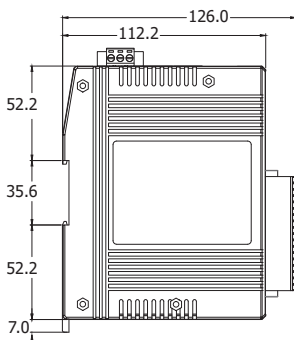

Left Side View

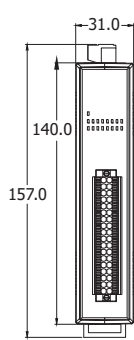

Front View

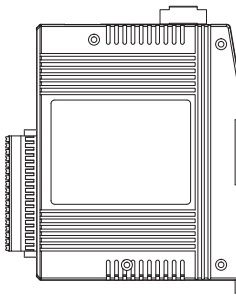

Right Side View



Rear View

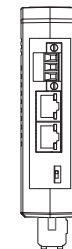

Top View

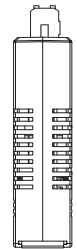

Bottom View

Ordering Information

ET-2251 CR	Ethernet I/O Module with 2-port Ethernet Switch and 16-ch DI (RoHS)
PET-2251 CR	PoE Ethernet I/O Module with 2-port Ethernet Switch and 16-ch DI (RoHS)
ET-2251-32 CR	Ethernet I/O Module with 2-port Ethernet Switch and 32-ch DI (RoHS)
PET-2251-32 CR	PoE Ethernet I/O Module with 2-port Ethernet Switch and 32-ch DI (RoHS)