

ET-2200 Series Ethernet I/O Modules User Manual



Ethernet I/O Module Ver. 1.6.0, Mar. 2023

WARRANTY

All products manufactured by ICP DAS are warranted against defective materials for a period of one year from the date of delivery to the original purchaser.

WARNING

ICP DAS assumes no liability for damages consequent to the use of this product. ICP DAS reserves the right to change this manual at any time without notice. The information furnished by ICP DAS is believed to be accurate and reliable. However, no responsibility is assumed by ICP DAS for its use, nor for any infringements of patents or other rights of third parties resulting from its use.

COPYRIGHT

Copyright © 2020 by ICP DAS. All rights are reserved.

TRADEMARK

Names are used for identification only and may be registered trademarks of their respective companies.

CONTACT US

If you have any questions, please feel free to contact us via email at: service@icpdas.com



TABLE OF CONTENTS

1. INTRODUCTION	6
1.1 Packing List.....	6
1.2 Features.....	7
1.3 Application	11
2. HARDWARE INFORMATION.....	12
2.1 Appearance	12
2.2 Specification.....	15
2.3 Wiring Connections.....	17
2.4 Wiring to the Connector	18
2.5 Dimensions.....	19
3. GETTING STARTED	24
3.1 Configuring the Boot Mode	24
3.2 Connecting the Power and the Host PC.....	25
3.3 Configuring the Network Settings.....	26
3.4 Modbus TCP Testing.....	28
4. WEB CONFIGURATION	30
4.1 Logging into the Web Server.....	30
4.2 Home.....	32
4.2.1 Home – DI/DO	32
4.2.2 Home – AI	33
4.2.3 Home – AO	34
4.3 Network.....	35
4.3.1 IP Address Configuration	35
4.3.2 General Settings	39
4.3.3 Restore Factory Defaults/Firmware Update.....	40
4.4 I/O Settings.....	43
4.4.1 DO Control.....	43
4.4.2 DI/DO Configuration.....	44
4.4.3 Analog Input Configuration	47
4.4.4 Analog Input Calibration.....	48
4.4.5 RTC.....	49

4.4.6	Data Logger.....	49
4.4.7	Analog Output Configuration	51
4.5	Sync	52
4.5.1	DIO Synchronization	52
4.6	PWM.....	54
4.6.1	PWM Configuration	54
4.7	MQTT (AI).....	55
4.8	Pair Connection	56
4.8.1	I/O Pair-Connection Settings	56
4.9	Filter	59
4.9.1	Filter Settings.....	59
4.10	Monitor	60
4.11	Change Password	61
4.12	Logout	62
4.13	MQTT.....	63
4.13.1	Connectivity Settings.....	64
4.13.2	Publication Settings	66
4.13.3	Restore Factory Defaults	67
4.14	MQTT-DO.....	68
4.14.1	MQTT – Digital Outputs.....	69
4.14.2	Readbacks of the Digital Outputs.....	70
4.15	MQTT-DI	71
4.15.1	MQTT – Digital Inputs.....	72
4.16	MQTT-AI	73
4.17	MQTT- Realization	74
4.17.1	Set up Mosquitto.....	74
4.17.2	Introduction to MQTTLens	80
4.17.3	ET-2200 Periodic Publish Realization.....	83
4.18	SNMP.....	85
4.18.1	SNMP Configuration Setting.....	86
4.18.2	SNMP Specific Trap.....	87
4.18.3	SNMP I/O Example	89
4.18.4	SNMP Trap Example	94
4.18.5	SNMP Problem Solving.....	96

5. I/O PAIR CONNECTION APPLICATIONS.....	98
5.1 One Module Polling the Remote DI/DO (1-to-1, Pull / Push Mode).....	98
5.1.1 Pull Mode	100
5.1.2 Push Mode.....	101
5.2 Two Modules Pushing the Local DI to each other (1-to-1, Push Mode).....	102
5.3 Several Modules Pulling the Remote DI (M-to-1) (Pull Mode)	105
5.4 Several Modules Pushing the Local DI (M-to-1) (Push Mode).....	108
5.5 Shared Memory.....	111
5.5.1 Address Mapping for Shared Memory	112
5.5.2 Application of spreading the load	113
5.5.3 Master/Slave/MTCP/MUDP Data Exchange	115
5.5.4 Bits / Registers Data Exchange	116
6. MODBUS INFORMATION.....	117
6.1 What is Modbus TCP/IP?	117
6.2 Modbus Message Structure	118
6.2.1 01(0x01) Read the Status of the Coils (Read DO Readback values)	121
6.2.2 02(0x02) Read the Status of the Input (Read DI values)	123
6.2.3 03(0x03) Read the Holding Registers (Read AO Readback values)	125
6.2.4 04(0x04) Read the Input Registers (Read AI values)	127
6.2.5 05(0x05) Force a Single Coil (Write DO value)	129
6.2.6 06(0x06) Set a Single Register (Write AO value)	131
6.2.7 15(0x0F) Force Multiple Coils (Write DO values)	133
6.2.8 16(0x10) Set Multiple Registers (Write AO values)	135
6.3 Modbus Register Table (For DIO Module).....	137
6.3.1 Common Functions	137
6.3.2 Specific Functions	139
6.4 Modbus Register Table (For AIO Module).....	143
6.4.1 Modbus Register Table for (P)ET-2217	143
6.4.2 Modbus Register Table for ET-2217CI.....	147
6.4.3 Modbus Register Table for (P)ET-2224/2228.....	150
6.5 Analog Input Type and Data Format Table.....	153
APPENDIX A: TROUBLESHOOTING	154
A.1 How do I restore the web password for the module to the factory defaults?	154
A.2 How to update the firmware via Ethernet?	156

A.3 Why is the Host computer unable to ping or search for the ET-2200 module? 159

A.4 What is Digital-Input Filter (DI Filter)? 160

APPENDIX B: REVISION HISTORY 161

1. Introduction

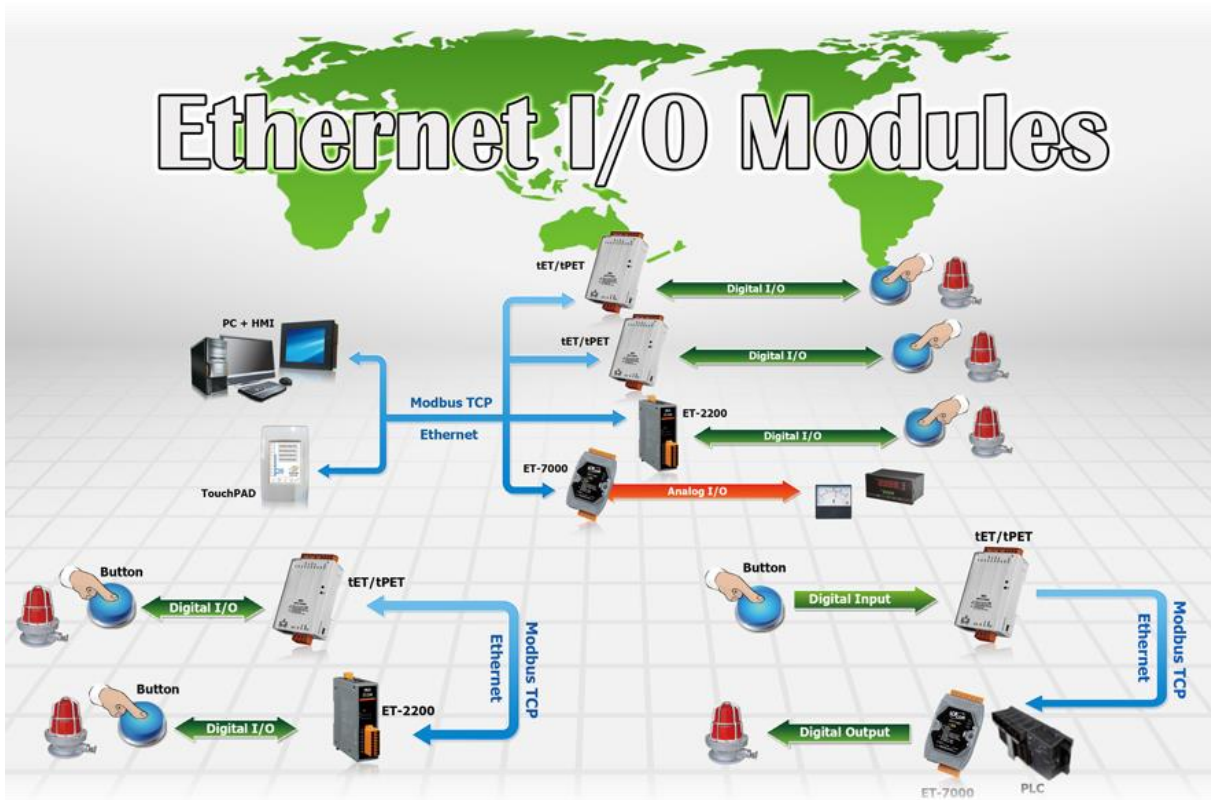

The ET-2200 series modules, an IP-based Ethernet I/O module, feature a built-in web server that allows configuration, I/O monitoring, and I/O control by simply using a regular web browser. In addition, the ET-2200 also supports Modbus TCP/UDP protocol that makes perfect integration to SCADA software.

1.1 Packing List

The shipping package includes the following items:



ET-2200 Module x 1



Quick Start x 1



Note:

If any of these items are missing or damaged, please contact the local distributor for more information. Save the shipping materials and cartons in case you need to ship the module in the future.

1.2 Features

1. Built-in Web Server

The ET-2200 series module has a built-in web server that allows users to easily configure, monitor, and control the module from a remote location using a web browser.

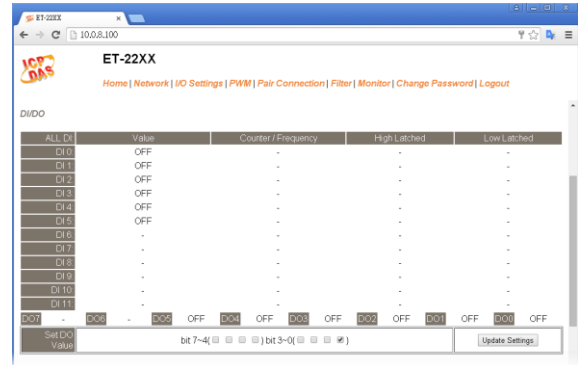

2. Modbus TCP/UDP, MQTT, or SNMP Protocols

The Modbus TCP and Modbus UDP slave functions on the Ethernet port can be used to provide data to remote SCADA software. All DI/DO modules and some AI/AO modules support MQTT and SNMP V2c protocols.

3. I/O Pair Connection (Push and Pull)

This function is used to create a DI to DO pair through the Ethernet. Once the configuration is completed, the ET-2200 module can continuously pull the status of the remote DI device using the Modbus TCP protocol and then write to local DO channels in the background.

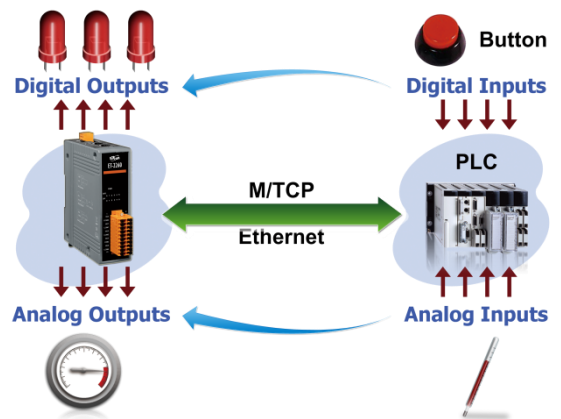

4. Slim-Type Housing

The ET-2200 modules are slim-type housing with about 3.3 cm in width. Compared with the palm-size module that has about 7 cm in width, more slim-type ET-2200 modules can be installed on the same DIN-Rail space.

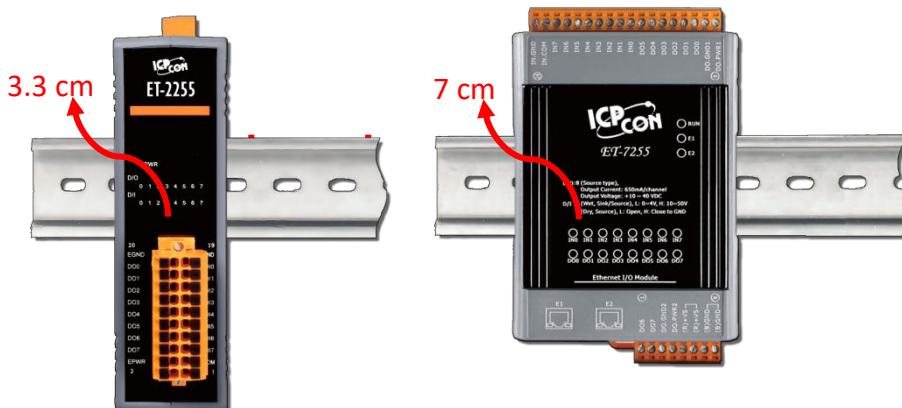

5. Built-in Multi-function I/O

➤ All **Digital Output** modules provide:

- A **Power-on Value**: On boot-up, the digital output value is set as the Power-on value.
- A Safe Value: If Modbus TCP communication is lost for a specific time, the digital output value will be set as the user-defined safe value.
- A **PWM Function**: The digital output channels support PWM (pulse generation) function that can be configured with different frequencies (100 Hz Max.) and different duty cycles for each channel. The term “High Duty Cycle” describes the duration of 'on' time in proportion to the regular interval or 'period' of time. Similarly, the term “Low Duty Cycle” corresponds to the duration of the 'off' time. Consequently, it is not necessary to keep switching from ON to OFF from a remote controller. In this way, the ET-2200 series module reduces the complexity required for the control system and enhances timing accuracy.



Note: Because of the characteristics of the relay functions, it is recommended that the PWM on modules with relay functions is not used for extended periods.

➤ All **Digital Input** modules provide:

- **Digital input channels can also be used as 32-bit high-speed (3 kHz) counters.**
- **High/Low Latched Status Commands:** The modules provide commands to read the status of any digital input channels that are latched high or latched low. The following is an example that shows the usefulness of the latched digital input. If we wish to read a keystroke from a key switch connected to the digital input channel of a module, the input signal of the keystroke is a pulse signal as shown in the figure.

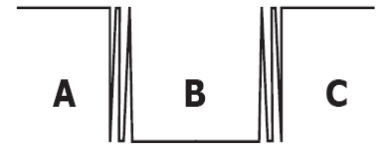

If we just use the read digital input status command to read the signal and cannot send the command during the B period for some reasons, then we will lose the keystroke information. However, with the read-latched digital input command, we can still get the keystroke information even if we are not able to send the command in the B period.

- **Frequency Measurement:**

ET-2200 series modules also provide a frequency measurement function that retrieves the digital input counter value at specific times and calculates the frequency. Rather than polling via a remote host, the ET-2200 series modules can determine the frequency directly, reducing the communication delay caused by two ends and also improving the accuracy of the frequency measurement. To apply for more applications, this module provides 3 scan modes and 4 moving average methods for the user to select the best way in their applications.

- **DIO Synchronization (Mirror Local DI to DO):** ET-2200 series modules also provide a DIO synchronization function. The DIO synchronization is divided into three modes: **Level Sync**, **Rising Active**, and **Falling Active**.

- **Level Sync (DO = DI) Mode:** The synchronization operation in DI and DO.

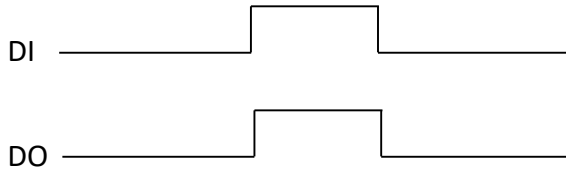

- **Rising Active (DO = ON) Mode:** When the specified DI state is from OFF to ON, the corresponding DO will be set to ON.

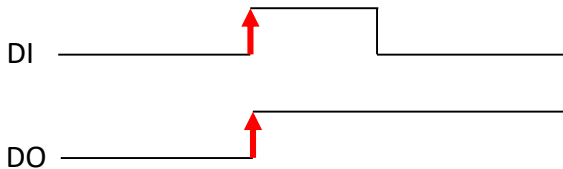

- **Falling Active (DO = ON) Mode:** When the specified DI state is from ON to OFF, the corresponding DO will be set to ON.

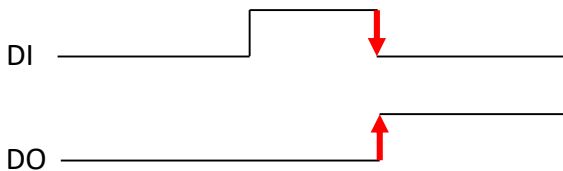

6. Built-in Dual Watchdog

The Dual Watchdog consists of a CPU Watchdog (for hardware functions) and a Host Watchdog (for software functions).

- **CPU Watchdog** automatically resets itself when the built-in firmware runs abnormally.
- **Host Watchdog** set the digital output with a predefined safe value when there is no communication between the module and host (PC or PLC) over a while (Watchdog timeout).



7. Daisy-chain Ethernet Cabling

The ET-2200 has a built-in two-port Ethernet switch to implement daisy-chain topology. The cabling is much easier and the total costs of cable and switch are significantly reduced.

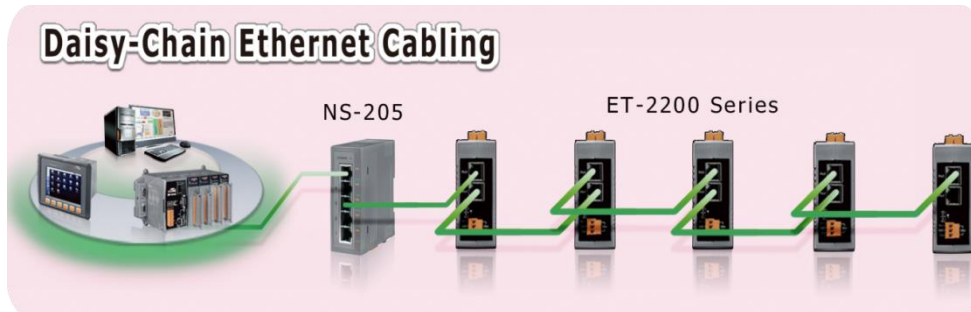

8. LAN Bypass

LAN Bypass feature guarantees Ethernet communication. It will automatically be active to continue the network traffic when the ET-2200 loses its power.

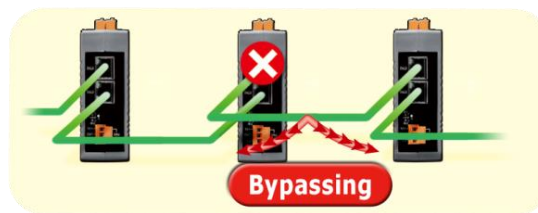

9. Highly Reliable Under Harsh Environment

- Wide Operating Temperature Range: -25 ~ +75°C
- Storage Temperature: -40 ~ +80°C
- Humidity 10 ~ 90% RH (Non-condensing)



1.3 Application

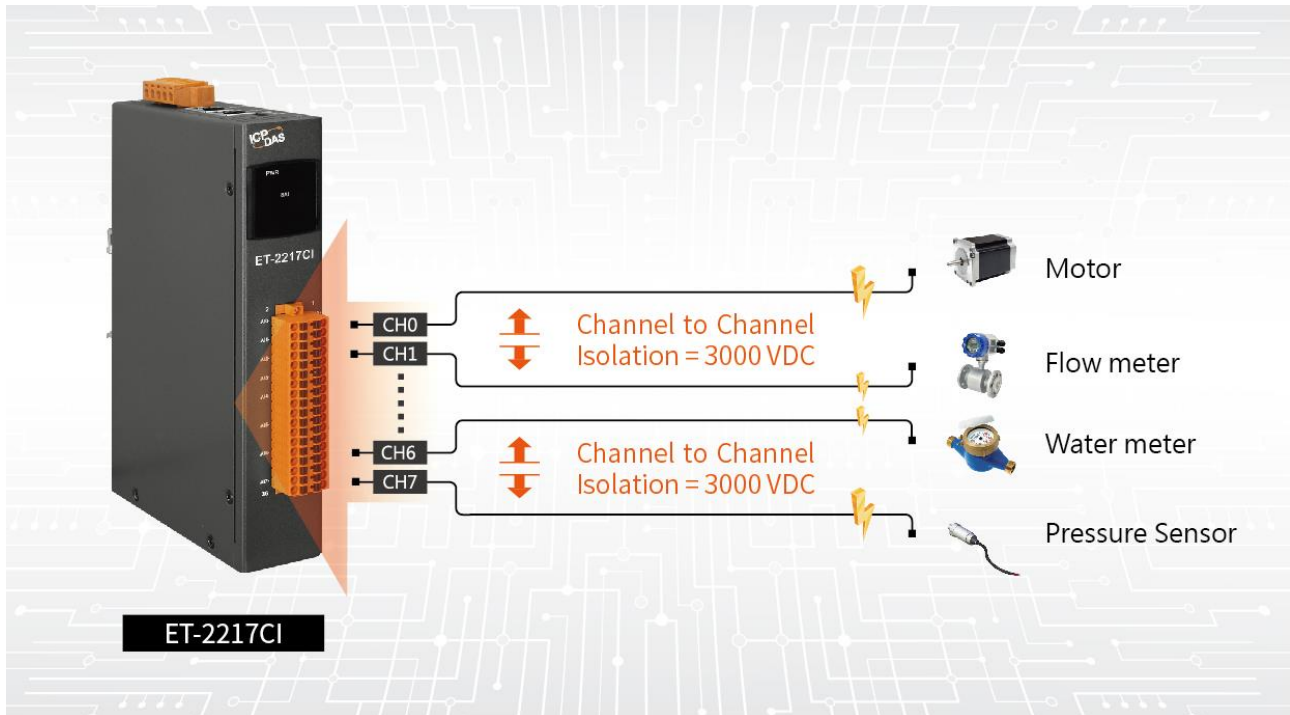

2. Hardware Information

2.1 Appearance

The front panel and top panel of the ET-2200 module contain the I/O connector, LEDs, Ethernet Port, and power connector.

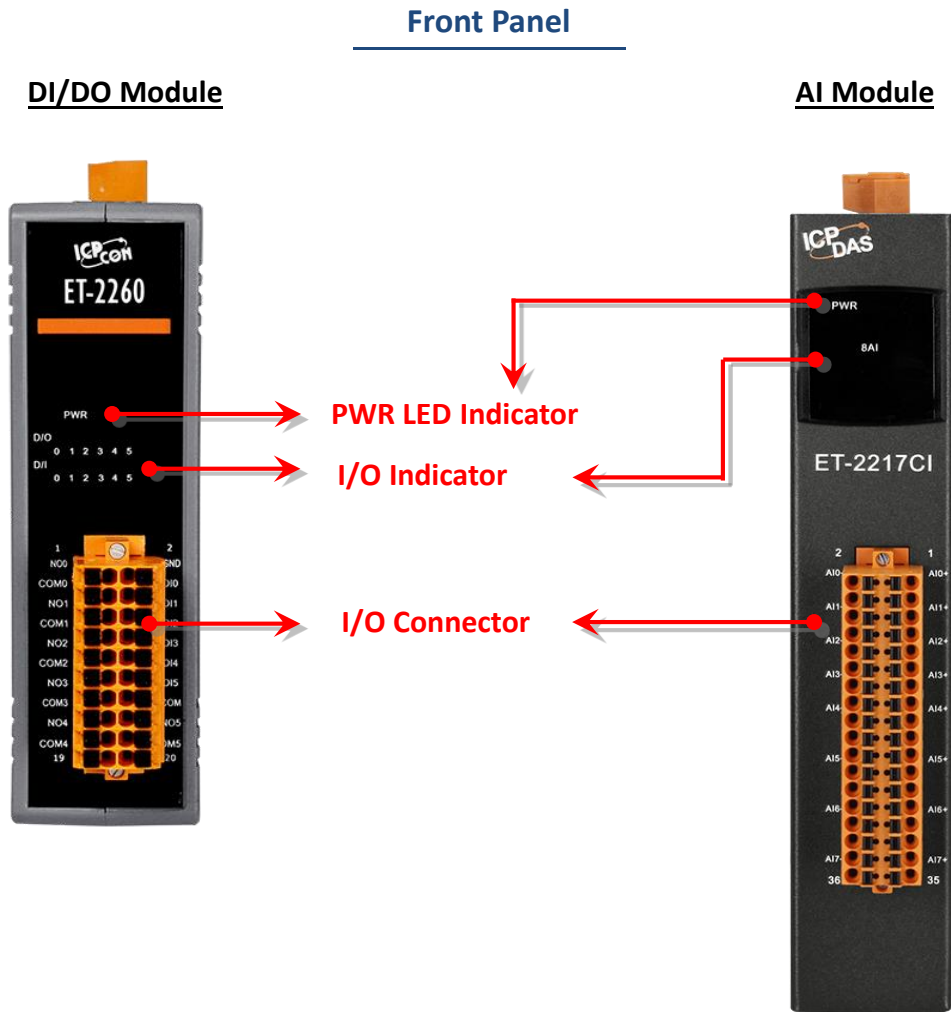

- **PWR LED Indicator**

Once power is supplied to the ET-2200 series module, the system LED indicator will illuminate.

- **I/O Indicator**

The exact design and functionality depend on the module type which indicates the I/O status.

● **I/O Connector**

For more detailed information regarding the pin assignments for the I/O connector, refer to [Section 2.3 “Pin Assignments”](#).

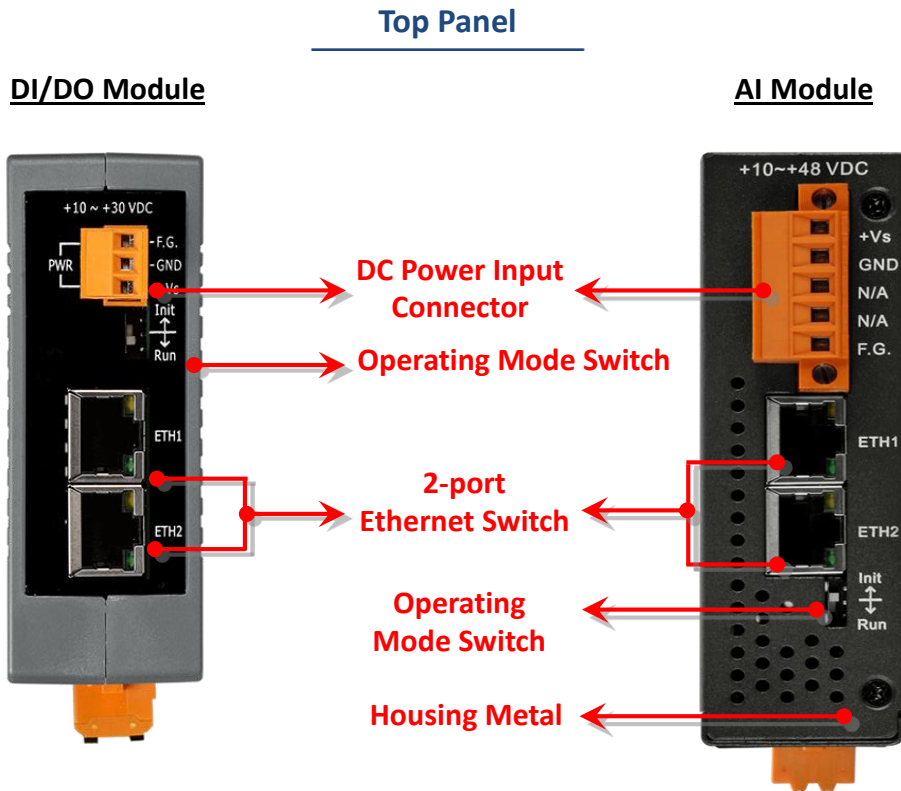

● **DC Power Input Connector**

The definition for “+Vs” and “GND” for use as the power supply applies to all types of ET-2200 series modules.

The valid power voltage range is from **+10 to +30 V_{DC}** or **+10 to +48 V_{DC}**.
(Refer to Section 2.2.1)

The definition for “F.G.” (Frame Ground):

Electronic circuits are constantly vulnerable to Electrostatic Discharge (ESD), which becomes worse in a continental climate area. ET-2200 series module features a new design for the frame ground, which provides a path that bypasses ESD, resulting in an enhanced ESD protection capability and ensuring that the module is more reliable.

- **Operating Mode Switch**

Init Mode: Use factory default settings for troubleshooting.

Run Mode: Use customer settings for normal operations.

The default setting of the operating mode is set to "Run". Refer to [Section 3.1 "Configuring the Boot Mode"](#) for more information.

- **2-Port Ethernet Switch**

The ET-2200 series modules are equipped with two RJ-45 10/100 Base-TX Ethernet switch ports. When an Ethernet link is detected and an Ethernet packet is received, the **Green LED** indicator and the **Yellow LED** indicator will be illuminated.

2.2 Specification

Product Page

The user can enter the model in the search bar on the website (<https://www.icpdas.com/>) to find out the product page.

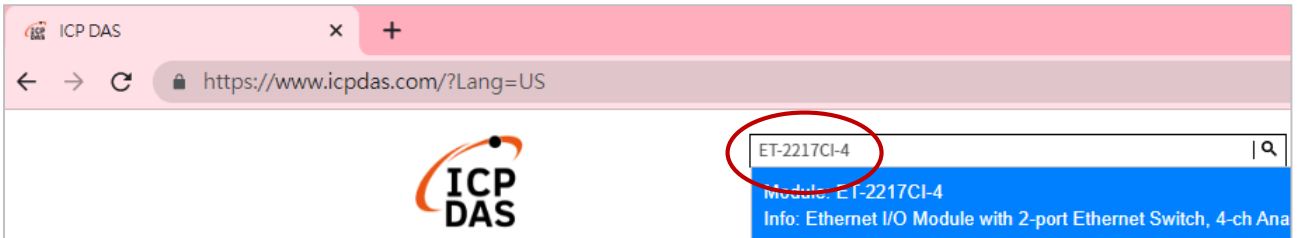

ET-2200 Selection Guide:

https://www.icpdas.com/en/product/guide+Remote_I_O_Module_and_Unit+Ethernet_I_O_Modules+ET-2200#2724

HOME > PRODUCTS > Remote I/O Module and Unit > Ethernet I/O Modules > ET-2200

Introduction		Selection Guide				Ethernet I/O Comparison Table		
▶ Available soon ▶ Will be phased out ▶ Phased out								
Analog Input Modules								
Model	AI					Protocol		
	Channels	Sampling Rate	Voltage & Current Input	Sensor Input	Channel to Channel Isolation	MQTT	SNMP V2c	
ET-2217CI-4 ▶	-	4	10/200Hz, for each channel	±1 V, ±2.5 V, ±5 V, ±10 V, ±20 mA,	-	Yes	Yes	-
ET-2217CI new	-	8						
ET-2217 ▶	PET-2217 ▶	8/16	20/200Hz	±150 mV, ±500 mV, ±1 V, ±2.5 V, ±5 V, ±10 V, ±20 mA, 0 ~ +20 mA, +4 ~ +20 mA	-	-	Yes	

Also, click the “Data Sheet” icon on the product page to find out the information on Dimensions, Pin Assignments, and Wire Connections.

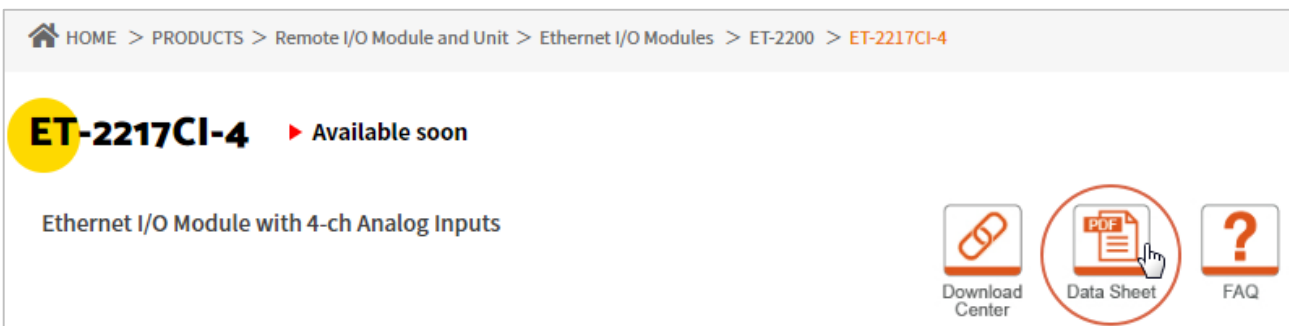

Data Sheet:

The following table lists the URL of the data sheet for the relevant models.

Model	File Name
www.icpdas.com/web/product/download/io_and_unit/ethernet/et2200/document/data_sheet/	
Analog Input Modules	
ET-2217CI-4, ET-2217CI	ET-2217CI-4_ET-2217CI_en.pdf
ET-2217, PET-2217	(P)ET-2217_en.pdf
Analog Output Modules	
ET-2224, PET-2224, ET-2228, PET-2228	(P)ET-2224_(P)ET-2228_en.pdf
ET-2224CI, ET-2228CI	ET-2224CI_ET-2228CI_en.pdf
Digital I/O Modules	
ET-2242, PET-2242, ET-2242-32, PET-2242-32	(P)ET-2242_(P)ET-2242-32_en.pdf
ET-2242U	ET-2242U_en.pdf
ET-2251, PET-2251, ET-2251-32, PET-2251-32	(P)ET-2251_(P)ET-2251-32_en.pdf
ET-2254, PET-2254, ET-2254P, PET-2254P	(P)ET-2254_(P)ET-2254P_en.pdf
ET-2255, PET-2255, ET-2255-32, PET-2255-32	(P)ET-2255_(P)ET-2255-32_en.pdf
ET-2255U, PET-2255U	(P)ET-2255U_en.pdf
Relay Output/Digital Input Modules	
ET-2260, PET-2260	(P)ET-2260_en.pdf
ET-2261, PET-2261	(P)ET-2261_en.pdf
ET-2261-16	ET-2261-16_en.pdf
ET-2268	ET-2268_en.pdf

2.3 Wiring Connections

The user can find out the Wire Connections diagram for each model in the data sheet on the website.

Wire Connections

Relay Output	ON State Readback as 1	OFF State Readback as 0
Form A Relay in NO1, NO3, NO4, NO7		
Form C Relay in NO0, NO2, NO4, NO6		

Note for the ET-2260/2261/2261-16/2268:

When inductive loads are connected to the relays, a large counter electromotive force may occur when the relay actuates because of the energy stored in the load. These flyback voltages can severely damage the relay contacts and greatly shorten the relay life. Limit these flyback voltages at your inductive load by installing a flyback diode for DC loads or a metal oxide varistor for AC loads.

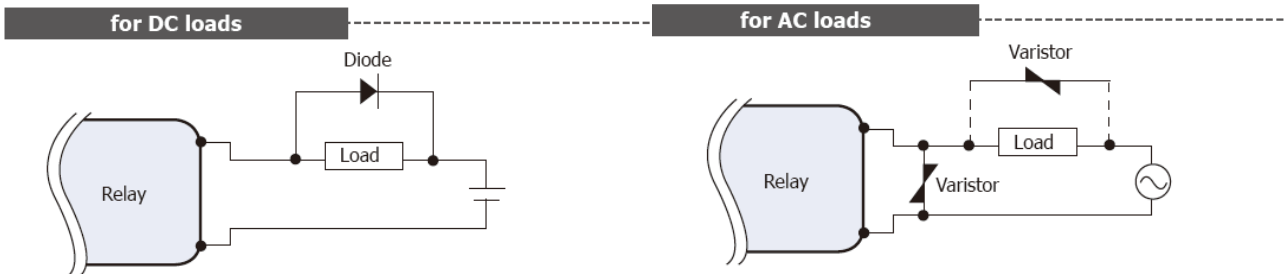

Varistor Selection:

Operating Voltage	Varistor Voltage	Max. Peak Current
100 ~ 120 V _{AC}	240 ~ 270 V _{AC}	> 1000 A
200 ~ 240 V _{AC}	440 ~ 470 V _{AC}	> 1000 A

2.4 Wiring to the Connector

➤ **Insulated Terminals Dimensions:**

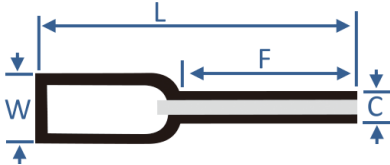

Dimensions (Unit: mm)				
Item NO.	F	L	C	W
CE007512	12.0	18.0	1.2	2.8

➤ **A tip for connecting the wire to the connector**

1. Use the blade of the flat-head screwdriver to push down the wire clamp.

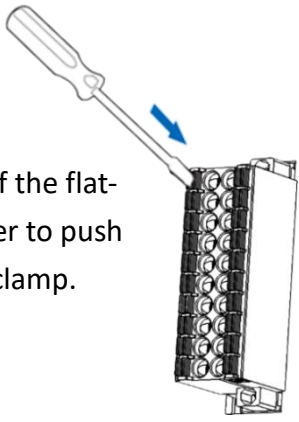

2. While holding the screwdriver in place, insert the wire into the terminal block.

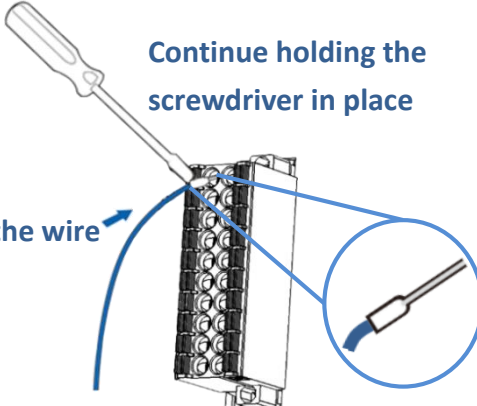

Continue holding the screwdriver in place

Insert the wire

➤ **A tip for removing the wire from the connector**

1. Use the blade of the flat-head screwdriver to push down the wire clamp.

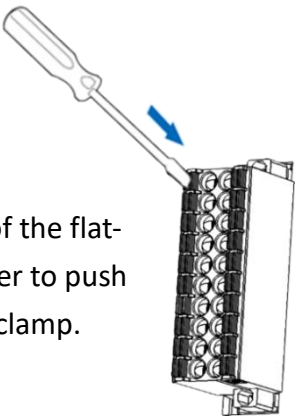

2. While holding the screwdriver in place, remove the wire from the terminal block.

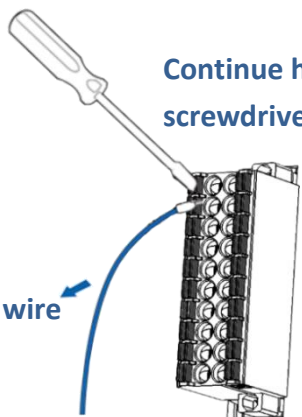

Continue holding the screwdriver in place

Remove the wire

2.5 Dimensions

The following diagrams provide the dimensions of the ET-2200 series module and can be used as a reference when defining the specifications for any custom enclosures. All dimensions are in millimeters.

➤ **(P)ET-2217:**

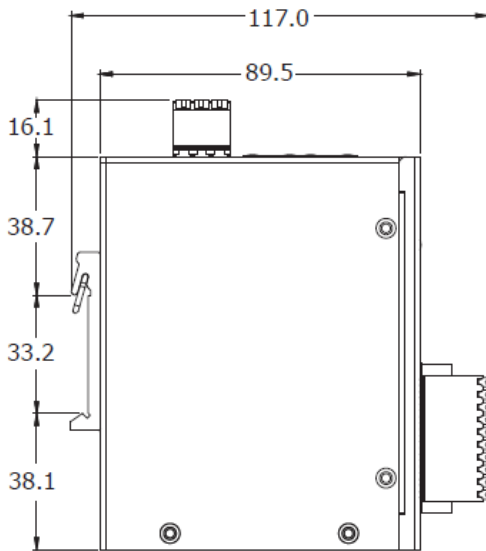

Right Side View

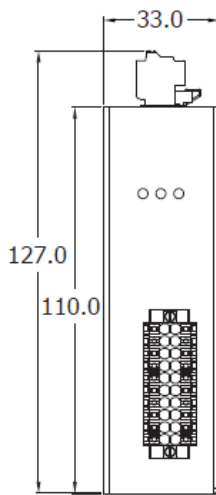

Front View

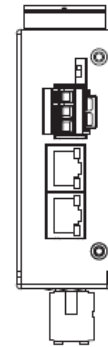

Top View

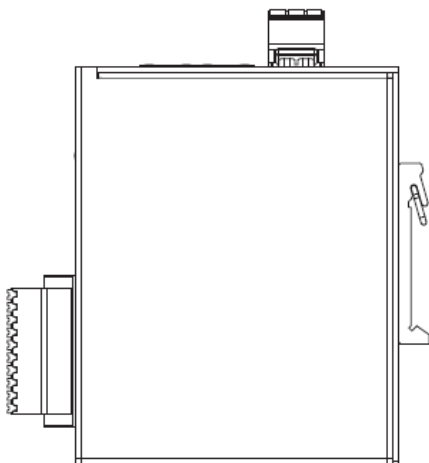

Left Side View

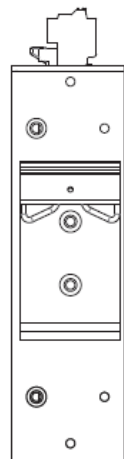

Rear View

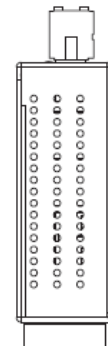

Bottom View

➤ ET-2217CI, ET-2217CI-4, ET-2224CI, ET-2228CI:

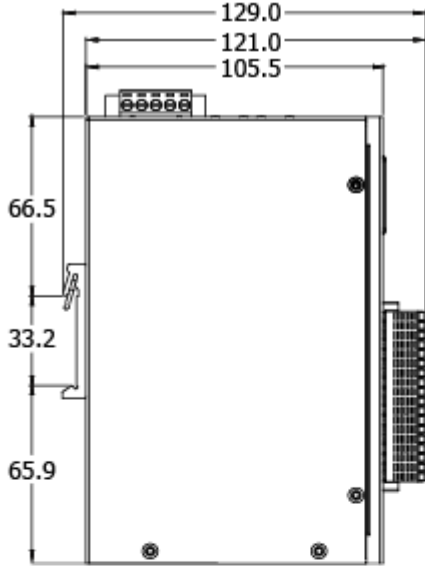

Right Side View

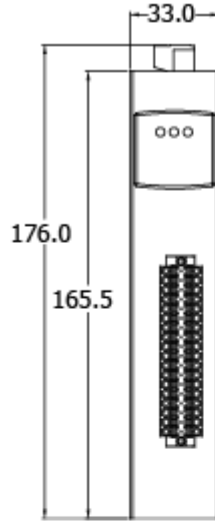

Front View

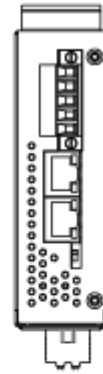

Top View

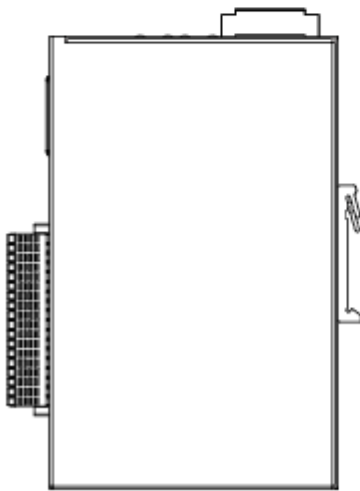

Left Side View



Rear View

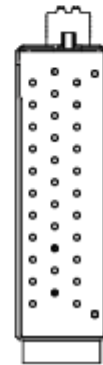

Bottom View

➤ (P)ET-2224, (P)ET-2228:

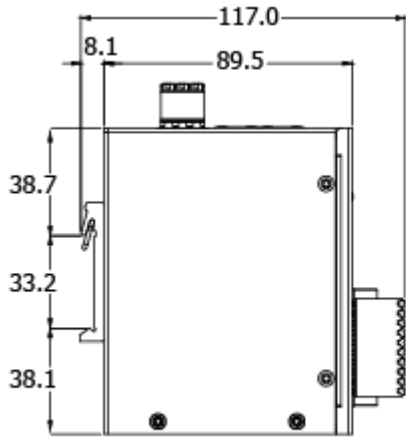

Right Side View

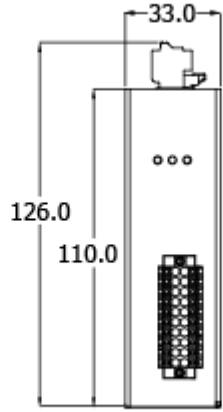

Front View

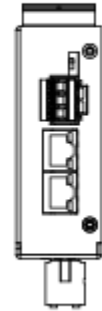

Top View

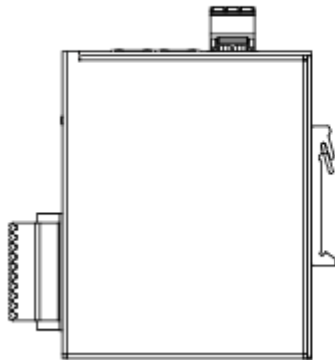

Left Side View

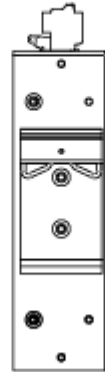

Rear View

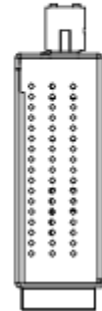

Bottom View

➤ (P)ET-2242, ET-2242U, ET-2254(P), (P)ET-2255, ET-2255U, ET-2260, ET-2261, ET-2268:

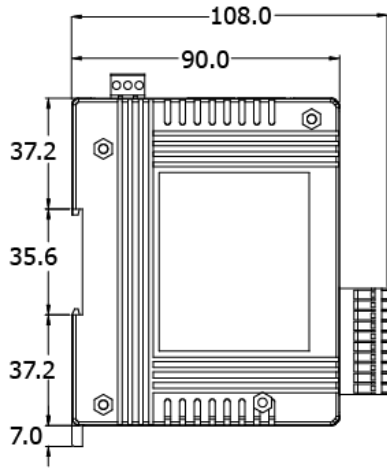

Right Side View

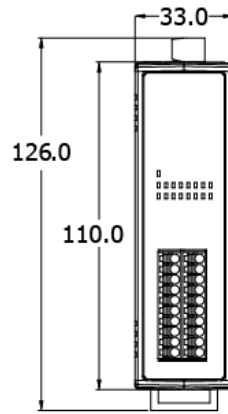

Front View

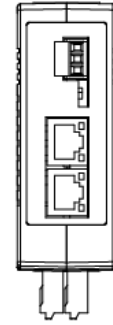

Top View

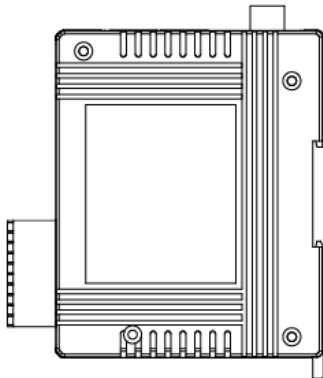

Left Side View

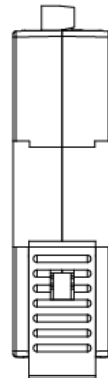

Rear View



Bottom View

➤ (P)ET-2242-32, (P)ET-2251-32, (P)ET-2255-32, ET-2261-16:

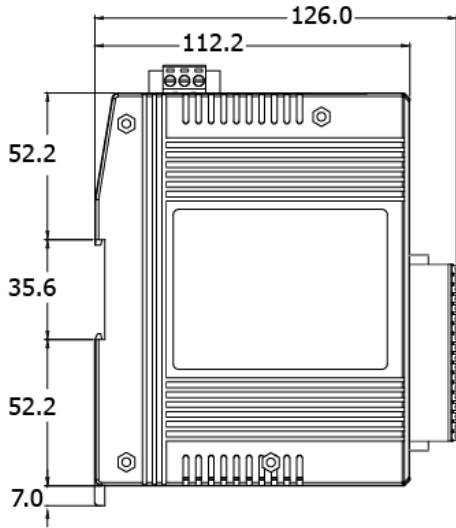

Right Side View

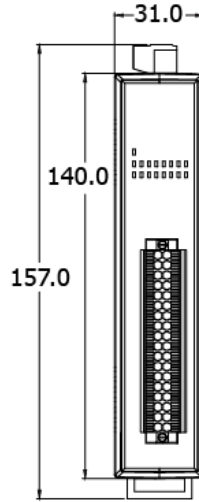

Front View

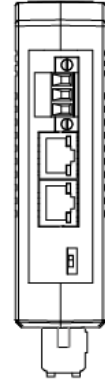

Top View

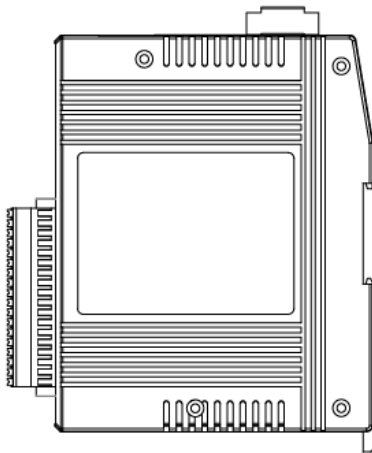

Left Side View

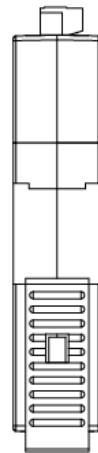

Rear View

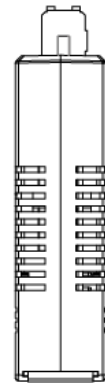

Bottom View

3. Getting Started

This chapter provides a basic overview of how to configure and operate your ET-2200 series module.

3.1 Configuring the Boot Mode

The ET-2200 series modules have two operating modes that can be selected by using the switch mechanism incorporated into the chassis.

 **Note that the module must be rebooted after changing the operating mode.**

➤ Init Mode

Init Mode should only be selected for troubleshooting:

1. Put the switch in the "**Init**" position and then reboot the module to load factory settings.
2. Use eSearch Utility to reconfigure the module's network settings.
3. Put the switch back in the "**Run**" position and then reboot the module to work in Run mode.

➤ Run Mode

Run Mode is the default operating mode and should be used in most cases.



3.2 Connecting the Power and the Host PC

Step 1: Connect both the ET-2200 module and the Host PC to the same sub-network or the same Ethernet Switch

Ensure that the network settings on the Host PC have been correctly configured and are functioning normally. Ensure that the Windows firewall or any Anti-Virus firewall is properly configured to allow incoming connections, or temporarily disable these functions, otherwise, the **“Search Servers”** function in the eSearch Utility described in [Section 3.3 “Configuring the Network Settings”](#) may not perform as expected. Contact the System Administrator for instructions on how to do this.

Step 2: Apply power to the ET-2200. The valid power voltage range depends on the ET-2200 series module.

Note: PET-2200 can use with the PoE switch.

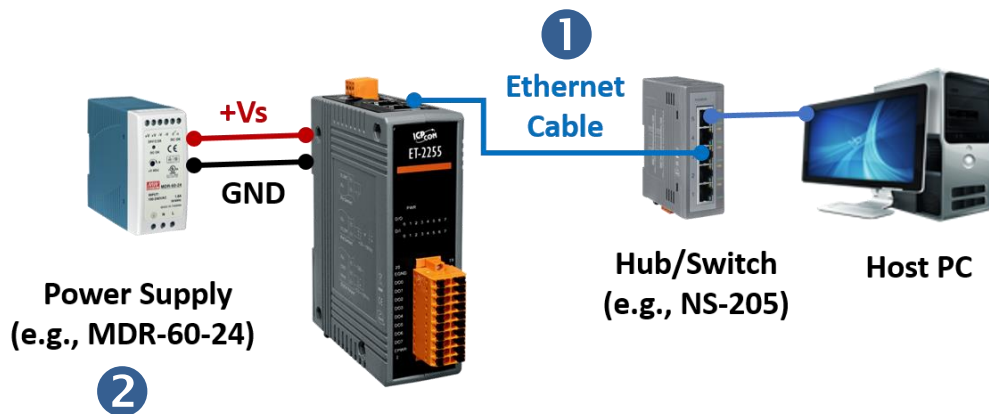

Step 3:
Verify that the “PWR” LED indicator on the ET-2200 module is flashing



3.3 Configuring the Network Settings

Step 1: Get the eSearch Utility

The eSearch Utility can be obtained from the ICP DAS website at:

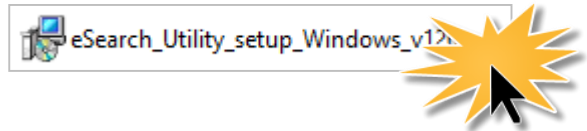

<https://www.icpdas.com/en/download/index.php?nation=US&kind1=&model=&kw=eSearch>

Step 2: Install the eSearch Utility

Follow the steps as suggested by the eSearch setup wizard to finish the installation.

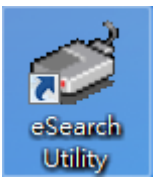

After the installation has been completed, a new shortcut for the eSearch Utility will be displayed on your desktop.

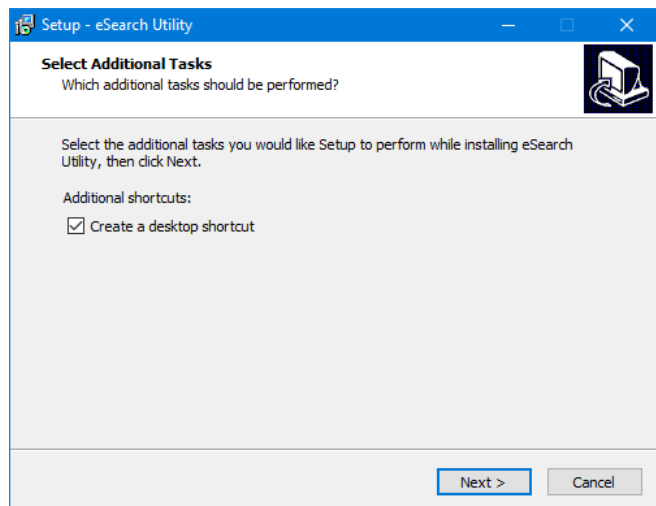

Double-click the icon to run eSearch Utility.

Step 3: Click the “Search Servers” button to search for the ET-2200 module

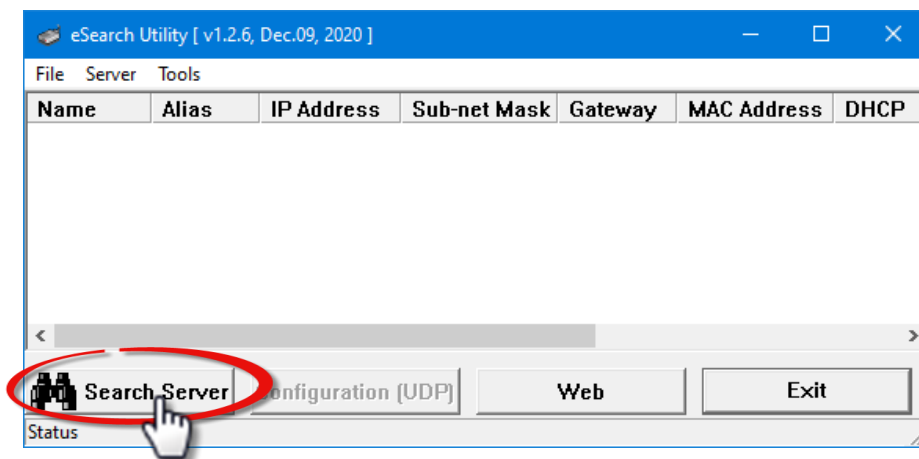

Step 4: Once the search process is complete, double-click the name of the ET-2200 module to open the “Configure Server (UDP)” dialog box

Factory Default Settings for the ET-2200 Series, as follows:

IP	192.168.255.1
Gateway	192.168.0.1
Mask	255.255.0.0

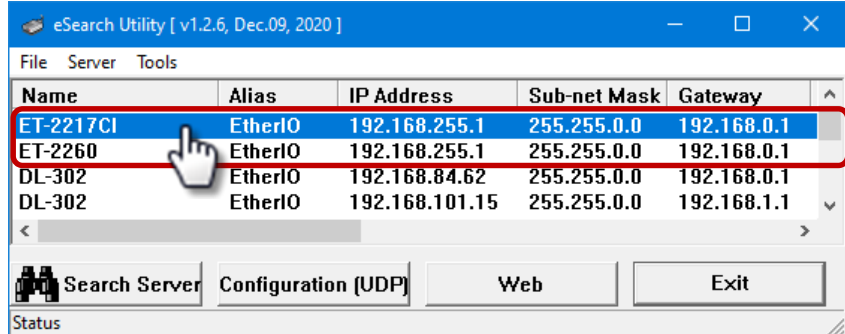

Step 5: Assign a new IP address and then click the “OK” button.

Enter the relevant values for the **IP Address, Subnet Mask and Gateway**, etc., and then click the **“OK”** button. The new settings for the ET-2200 module will take effect within 2 seconds. Contact your Network Administrator If the configuration is unknown.

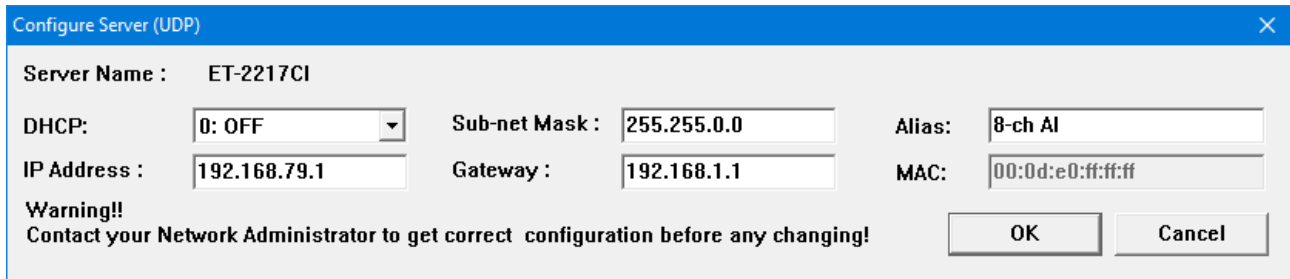

Step 6: Wait for 2 seconds and then click the “Search Servers” button again to ensure that the ET-2200 module is operating correctly using the new configuration

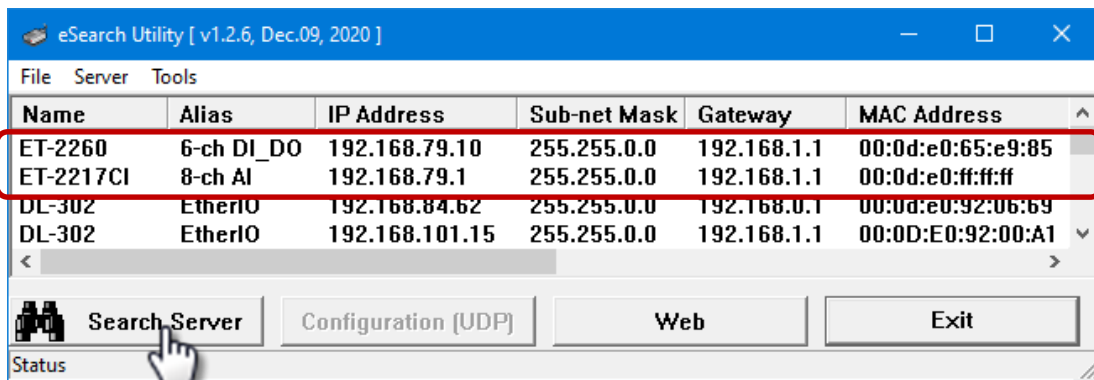

3.4 Modbus TCP Testing

Step 1: In the eSearch Utility, Select the “Modbus TCP Master” item from the “Tools” menu to open the Modbus TCP Master Utility.

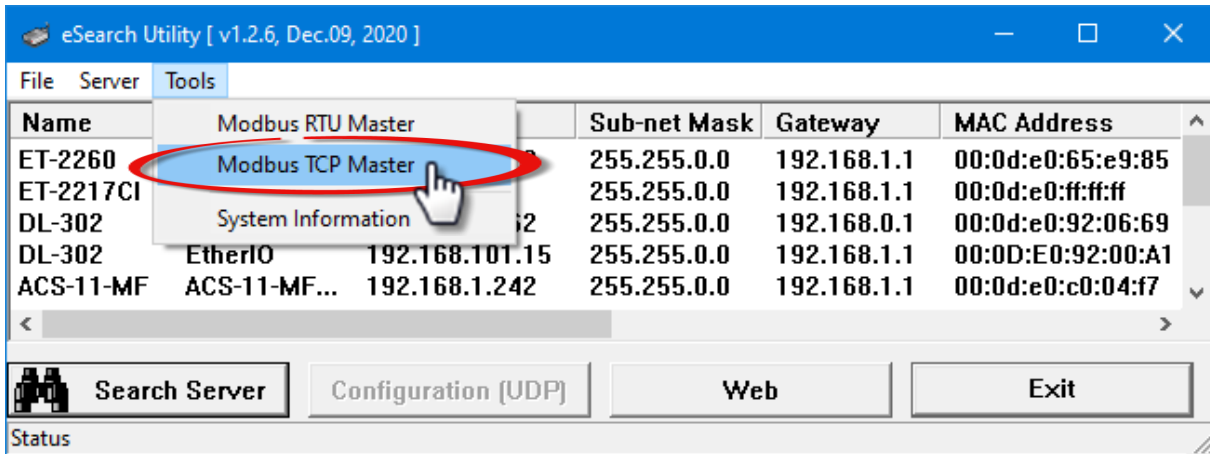

Step 2: Enter the IP address and TCP Port for the ET-2200 module in the “Modbus TCP” section, and then click the “Connect” button to connect to the ET-2200.

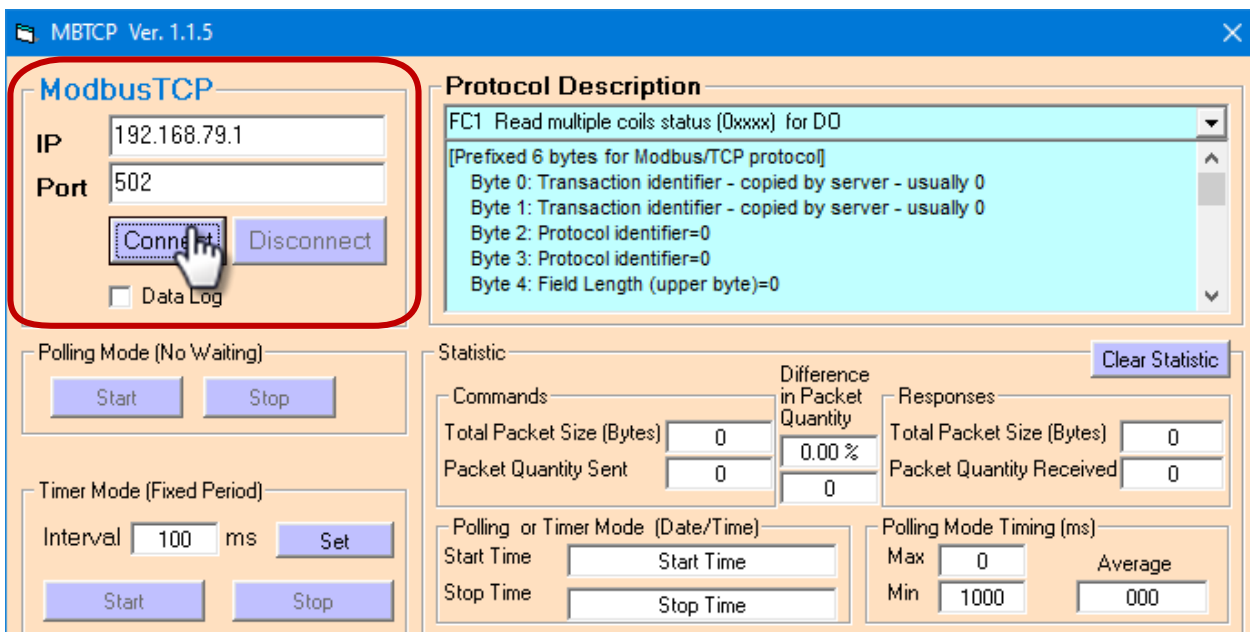

Step 3: Refer to the “Protocol Description” field in the top right-hand section of the Modbus Utility windows. You can send a request command and confirm that the response is correct.

Example:

The Modbus NetID for the ET-2200 is **1** (refer to [Section 4.3.1](#)). Please send the command “1 2 0 0 6 1 3 1 3 0 1” and the response will be “1 2 0 0 5 1 3 2 **22 17**” which indicates the model is 2217.

Refer to the example in [Section 6.2.3](#) and [Section 6.2 Modbus Message Structure](#).

1. Command	Leading	Request
	01 02 00 00 00 06	01 03 01 03 00 01
2. Response	Leading	Response
	01 02 00 00 00 05	01 03 02 22 17

4. Web Configuration

All ET-2200 series modules contain an advanced embedded web configuration system that provides I/O accessibility to the ET-2200 series module via a web browser.

4.1 Logging into the Web Server

You can access the embedded ET-2200 series web server from any computer that has an Internet connection.

Step 1: Launch web browser

Open a standard web browser. For example, Mozilla Firefox, Google Chrome, and Internet Explorer are reliable and popular internet browsers that can be used to configure the ET-2200 series module.



Note that if you intend to use Internet Explorer, ensure that the cache function is disabled to avoid browser access errors.

Step 2: Enter the URL for the ET-2200 module in the address bar of the browser or click the “Web” button in the eSearch Utility

Ensure that you have correctly configured the network settings for the ET-2200 series module, or refer to [Section 3.3 “Configuring the Network Settings”](#).

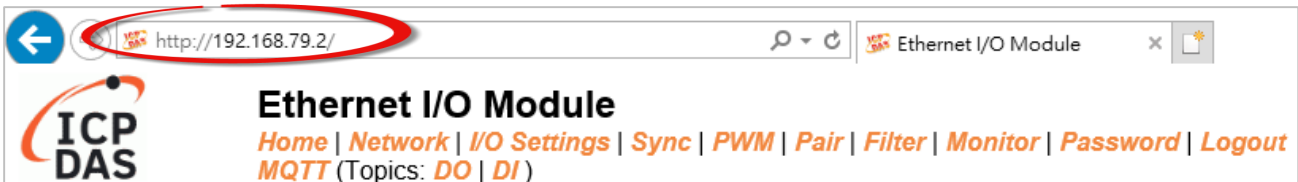

Step 3: Enter the password to log into the ET-2200 Web Server

Once the login screen is displayed, enter the password in the related fields (the default password is “Admin”), and then click the “Submit” button to enter the configuration web page.

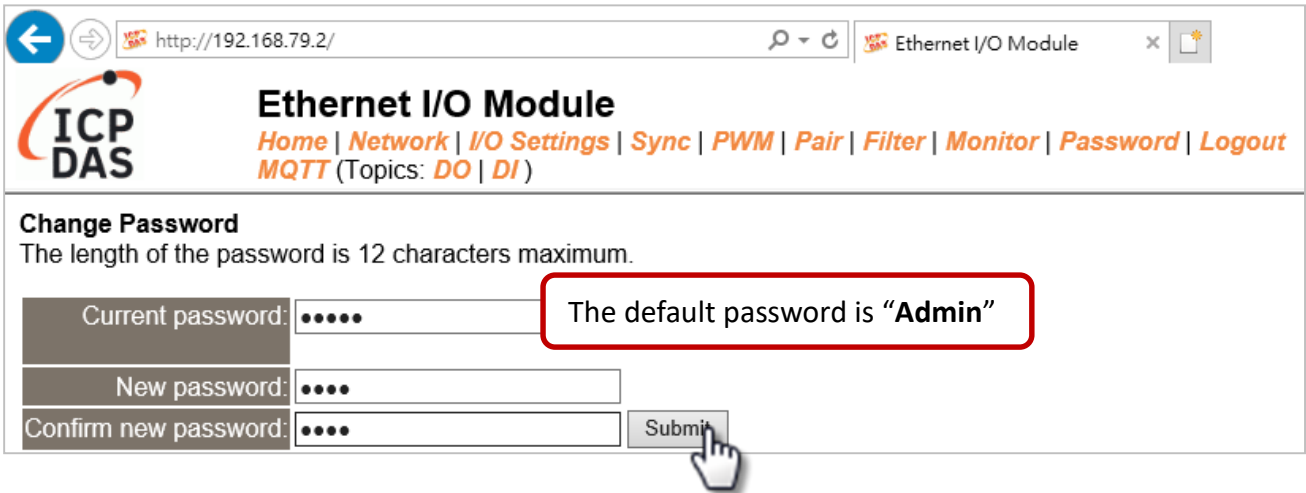

Refer to [Section 4.10 “Change Password”](#) if you want to change the password. After logging into the ET-2200 web server, the main page will be displayed. See Section 4.2 for more information.

Function Tabs for I/O Modules:

Note: “MQTT” is not available for ET-2217/ET-2224/ET-2228.

Function Tabs	DI	DO	AI	AO
Home	O	O	O	O
Network	O	O	O	O
I/O Settings	O	O	O	O
MQTT	O	O	O	Note
Syn	O	O	-	-
PWM	O	O	-	-
Pair	O	O	O	O
Filter	O	O	O	O
Monitor	O	O	O	O
Password	O	O	O	O
Logout	O	O	O	O

4.2 Home

Clicking the **Home** tab will display the main page allowing you to verify the ET-2200 series module hardware and software information and IO control, each of which will be described in more detail below.

4.2.1 Home – DI/DO

The first section provides basic information about the module including the Model Name, Firmware Version, IP Address, TCP Port Timeout, Alias Name, MAC Address, Initial Switch position, and System Timeout.

Note: After updating the Firmware, the user can check the version information on this page.

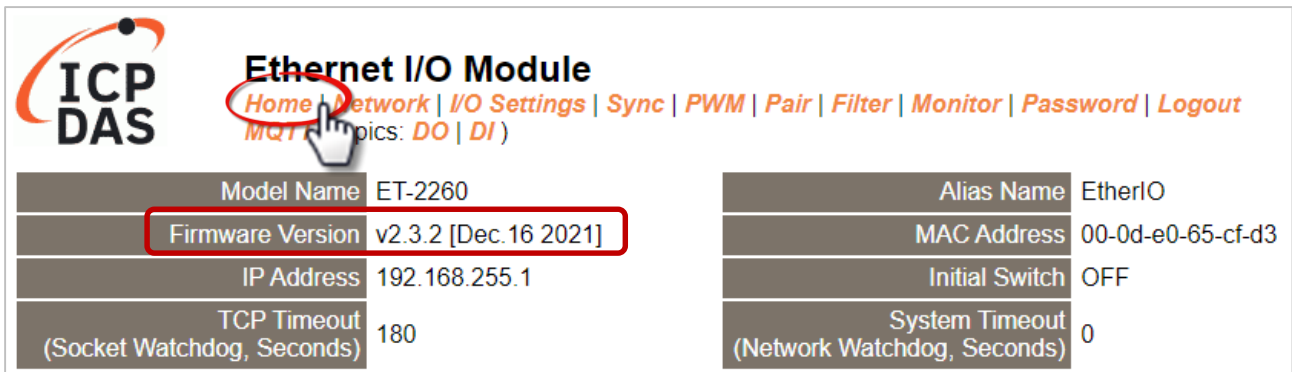

Model Name	ET-2260	Alias Name	EtherIO
Firmware Version	v2.3.2 [Dec.16 2021]	MAC Address	00-0d-e0-65-cf-d3
IP Address	192.168.255.1	Initial Switch	OFF
TCP Timeout (Socket Watchdog, Seconds)	180	System Timeout (Network Watchdog, Seconds)	0

The second section - Digital I/O provides information related to the current DIO status and DO control. **Note:** The user can click on the DO image to change the output status.

Digital I/O (Modbus Address: DO=00000 to 00015, DI=10000 to 10015.)

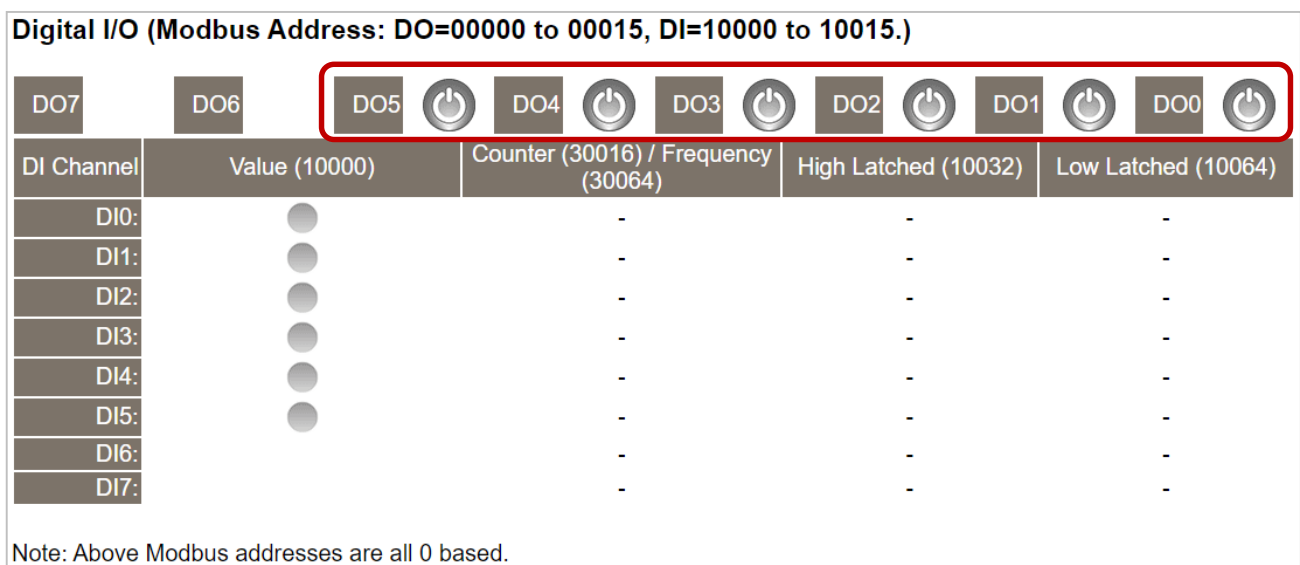

DI Channel	Value (10000)	Counter (30016) / Frequency (30064)	High Latched (10032)	Low Latched (10064)
DI0:	●	-	-	-
DI1:	●	-	-	-
DI2:	●	-	-	-
DI3:	●	-	-	-
DI4:	●	-	-	-
DI5:	●	-	-	-
DI6:	●	-	-	-
DI7:	●	-	-	-

Note: Above Modbus addresses are all 0 based.

4.2.2 Home – AI

This page will display different items depending on the model:

The first section provides basic information about the module including the Model Name, Firmware Version, IP Address, TCP Port Timeout, Alias Name, MAC Address, Initial Switch position, and System Timeout.

ICP DAS Ethernet I/O Module

[Home](#) | [Network](#) | [I/O Settings](#) | [MQTT](#) | [Pair](#) | [Filter](#) | [Monitor](#) | [Password](#) | [Logout](#)

Model Name	ET-2217CI	Alias Name	EtherIO
Firmware Version	v2.0.2 [Jan.28, 2021]	MAC Address	00-0D-E0-FF-FF-FF
IP Address	192.168.255.1	Initial Switch	OFF
TCP Port Timeout (Socket Watchdog, Seconds)	180	System Timeout (Network Watchdog, Seconds)	0

The second section - **Analog Input Readings**, provides information related to the AI data range, values, and latched values. In addition, the **RTC** section can display the system time. The **Current Port Setting** can display information about the Pair-Connection function.

Analog Input Readings

Analog Input Channel	Range (40096)	Value (30000)	Low Latched (30544)	High Latched (30512)
AI0	05: +/-2.5 V	+0.0009 000ch	-0.0020 ffe6h	+0.0009 000ch
AI1	06: +/-20 mA	+00.000 0001h	-00.019 ffe0h	+00.003 0006h
AI2	07: +4 mA to +20 mA	-9999.9 0000h	-9999.9 0000h	-9999.9 0000h
AI3	08: +/-10 V	+00.004 000dh	+00.002 0007h	+00.005 0013h
AI4	09: +/-5 V	+0.0053 0022h	+0.0010 0007h	+0.0057 0025h
AI5	0A: +/-1 V	-0.0041 ff7ah	-0.0041 ff79h	+0.0001 0003h
AI6	0D: +/-20 mA	+00.000 ffffh	-00.064 ff97h	+00.024 0028h
AI7	1A: 0 mA to +20 mA	+00.000 0000h	-9999.9 0000h	+00.016 0035h

RTC

Date	2022-09-15	Time	14:36:17
------	------------	------	----------

Current Port Settings

Pair-Connection Settings	Port 1
Server Mode	Server
Remote Server IP	Disabled
Remote TCP Port	Disabled

4.2.3 Home – AO

The first section provides basic information about the module including the Model Name, Firmware Version, IP Address, TCP Port Timeout, Modbus Format, Alias Name, MAC Address, Initial Switch position, System Timeout, and Host Timeout.

ICP DAS Ethernet I/O Module
[Home](#) | [Network](#) | [I/O Settings](#) | [Pair](#) | [Filter](#) | [Monitor](#) | [Password](#) | [Logout](#)

Model Name	P/ET-2228	Alias Name	EtherIO
Firmware Version	v01.0.0 [20220524]	MAC Address	00-0d-e0-ff-ff-33
IP Address	192.168.255.2	Initial Switch	OFF
TCP Timeout (Socket Watchdog, Seconds)	180	System Timeout (Network Watchdog, Seconds)	0
Modbus Format	Hexadecimal	Host Timeout (Safe Value, Seconds)	0

The second section - Analog Output, provides information related to the AO data type, read value, open wire detection, power-on value, safe value, and slew rate. Also, the AO value can be set.

Analog Output (Modbus Address: AO=40000 to 40007.)

AO Channel	Type (40459~466)	AO Read (40000~007)	AO Write (40000~007)	Submit Value	Wire Break (10290)
AO0:	0x32:0 ~ +10V	0.000	<input type="text" value="0.000"/>	<input type="button" value="Set Value"/>	-
AO1:	0x32:0 ~ +10V	0.000	<input type="text" value="0.000"/>	<input type="button" value="Set Value"/>	-
AO2:	0x32:0 ~ +10V	0.000	<input type="text" value="0.000"/>	<input type="button" value="Set Value"/>	-
AO3:	0x32:0 ~ +10V	0.000	<input type="text" value="0.000"/>	<input type="button" value="Set Value"/>	-
AO4:	0x32:0 ~ +10V	0.000	<input type="text" value="0.000"/>	<input type="button" value="Set Value"/>	-
AO5:	0x32:0 ~ +10V	0.000	<input type="text" value="0.000"/>	<input type="button" value="Set Value"/>	-
AO6:	0x32:0 ~ +10V	0.000	<input type="text" value="0.000"/>	<input type="button" value="Set Value"/>	-
AO7:	0x32:0 ~ +10V	0.000	<input type="text" value="0.000"/>	<input type="button" value="Set Value"/>	-

AO Channel	Power On Value (40360~367)	Safe Value (40392~399)	Slew Rate (40523~530)
AO0:	0.000	0.000	0x00:Immediate
AO1:	0.000	0.000	0x00:Immediate
AO2:	0.000	0.000	0x00:Immediate
AO3:	0.000	0.000	0x00:Immediate
AO4:	0.000	0.000	0x00:Immediate
AO5:	0.000	0.000	0x00:Immediate
AO6:	0.000	0.000	0x00:Immediate
AO7:	0.000	0.000	0x00:Immediate

Current port settings:

Pair-Connection Settings	Port 1
Server Mode	Server
Remote Server IP	Disabled
Remote TCP Port	Disabled

Note: Above Modbus addresses are all 0 based.

4.3 Network

Note: The function is available for AIO and DIO modules.

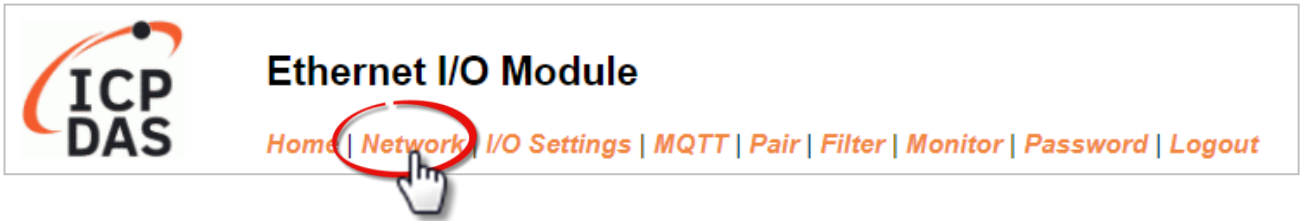

The **Network** page provides four sections, each of which will be described in more detail below.

1. IP Address:

It can be used to configure the Ethernet settings for ET-2200, e.g., the IPv4 address, the IPv6 address, DNS settings, and Modbus TCP Slave settings.

2. General Settings:

It can be used to configure the Ethernet speed, system timeout, TCP timeout, UDP heartbeat settings, and web auto-logout for ET-2200.

3. Other Operations:

It can be used to reset the ET-2200 to factory defaults or reboot, or remotely upgrade its firmware.

4.3.1 IP Address Configuration

IP Address

IPv4 Address				
Address Type	Static IP ▾			
Static IPv4 Address	192	168	255	2
Subnet Mask	255	255	0	0
Default Gateway	192	168	0	1
MAC Address	00-0d-e0-ff-ff-33 (Format: FF-FF-FF-FF-FF-FF)			
IPv6 Address				
Link Local Address	fe80:0:0:20d:e0ff:feff:ff33			
SLAAC Address	0:0:0:0:0:0:0			
SLAAC Timeout (SLAAC Watchdog)	0 (30 ~ 65000 seconds, 0 = Default Disabled)			
User-defined Address	fc00:0:0:0:0:0:0:1			
DNS Settings	Client Mode Only			
Auto DNS Configuration	Enable ▾ (Auto DNS Server Configuration by IPv4 DHCP. Default = Enable)			
Preferred DNS Server IP	208.67.222.222		IPv4 example: 208.67.222.222, IPv6 example: 2620:119:35::35	
Alternate DNS Server IP	208.67.220.220		IPv4 example: 208.67.220.220, IPv6 example: 2620:119:53::53	
Modbus TCP Slave				
Local Modbus TCP port	502		(Default= 502)	
Local Modbus NetID	1		(Default= 1)	
Check Modbus NetID	Enable ▾ (Process messages with correct NetID only. Default = Enable)			
<input type="button" value="Update Settings"/>				

Note: The IPv6 Address and DNS settings are not supported for some models.

The table describes the parameters contained in the "IP Address Configuration" section.

Item	Description
IPv4 Address	
Address Type	Static IP: If there is no DHCP server installed in your network, you can configure the network settings manually. Refer to Section "Manual Configuration" for more details.
	DHCP: Dynamic Host Configuration Protocol (DHCP) is a network application protocol that automatically assigns an IP address to each device. Refer to the Section "Dynamic Configuration" for more details.
Static IPv4 Address	This parameter is used to assign a specific IP address. Each ET-2200 module connected to the network must have its unique IP address.
Subnet Mask	This parameter is used to assign the subnet mask for the ET-2200 module. The subnet mask indicates which portion of the IP address is used to identify the local network or subnet.
Default Gateway	This parameter is used to assign the IP Address of the Gateway to be used by the ET-2200 module. A Gateway (or router) is a device that is used to connect an individual network to one or more additional networks.
MAC Address	This parameter is used to set the User-defined MAC address, which must be in the format FF-FF-FF-FF-FF-FF.
IPv6 Address	
Link Local Address	Each IPv6 device connected to the network must have a link-local address. The address is auto-configured by (P)ET-2200 and is always effective in the same link layer.
SLAAC Address	The (P)ET-2200 supports stateless address auto-configuration (SLAAC), which is automatically configured by the router. The default router is the link-local address of the router.
SLAAC Timeout (SLAAC Watchdog)	This parameter is used to set the Timeout value of SLAAC. If the SLAAC address is not assigned within the specified time, the system will reboot and configure the SLAAC address again.
User-defined Address	This parameter is used to set the IP address of the module. Each (P)ET-2200 connected to the network must have a unique IP address.

DNS Settings	
Auto DNS Configuration	<p>Enable: The IP address of the DNS Server is automatically set by IPv4 DHCP.</p> <p>Disable: Automatically set to the preferred IP address of the DNS Server.</p>
Preferred DNS Server IP	This parameter is used to set the preferred IP address of the DNS Server.
Alternate DNS Server IP	This parameter is used to set the alternate IP address of the DNS Server.
Modbus TCP Slave	
Local Modbus TCP port	This parameter is used to set the local port to be used by the Modbus slave device. The default value is 502.
Local Modbus NetID	This parameter is used to set the Network ID to be used by the Modbus slave device. The default value is 1.
Update Settings	Click this button to save the revised settings to the ET-2200 module.

Dynamic Configuration

Dynamic configuration is very easy to perform. If a DHCP server is connected to your network, a network address can be dynamically configured by using the following procedure:

Step 1: Select “**DHCP**” from the Address Type drop-down menu.

Step 2: Click the “**Update Settings**” button to complete the configuration.

IPv4 Address				
Address Type	DHCP			
Static IPv4 Address	192	168	79	2
Subnet Mask	255	255	0	0
Default Gateway	192	168	1	1
MAC Address	00-0d-e0-65-cf-d3 (Format: FF-FF-FF-FF-FF-FF)			
Modbus TCP Slave				
Local Modbus TCP port	502 (Default= 502)			
Local Modbus NetID	1 (Default= 1)			
Check Modbus NetID	Enable (Process messages with correct NetID only. Default = Enable)			
	Update Settings			

Manual Configuration

When using manual configuration, the network settings should be assigned as follows:

Step 1: Select “**Static IP**” from the **Address Type** drop-down menu.

Step 2: Enter the relevant details in the respective **network settings** fields.

Step 3: Click the “**Update Settings**” button to complete the configuration.

IPv4 Address				
Address Type	Static IP			
Static IPv4 Address	192	168	79	2
Subnet Mask	255	255	0	0
Default Gateway	192	168	1	1
MAC Address	00-0d-e0-65-cf-d3 (Format: FF-FF-FF-FF-FF-FF)			
Modbus TCP Slave				
Local Modbus TCP port	502 (Default= 502)			
Local Modbus NetID	1 (Default= 1)			
Check Modbus NetID	Enable (Process messages with correct NetID only. Default = Enable)			
	Update Settings			

4.3.2 General Settings

General Settings

Ethernet Speed	Auto ▾ (Auto=10/100 Mbps Auto-negotiation)
System Timeout (Network Watchdog)	0 (30 ~ 65535 s, Default= 0, Disable= 0) Action:Reboot
TCP Timeout	180 (5 ~ 65535 s, Default= 180, Disable= 0) Action:Cut-off
UDP Configuration	Enable ▾ (Enable/Disable the UDP Configuration, Enable=default.)
Web Auto-logout	10 (1 ~ 65535 minutes, Default= 10, Disable= 0)
HTTP port	80 (Default= 80)
Alias Name	EtherIO (Max. 18 chars)
Update Settings	

The table describes the parameters contained in the "**General Settings**" section.

Item	Description
Ethernet Speed	This parameter is used to set the Ethernet speed. The default value is Auto (Auto = 10/100 Mbps Auto-negotiation).
System Timeout (Network Watchdog)	This parameter is used to configure the system timeout value. If there is no activity on the network for a specific time, the system will be rebooted based on the configured system timeout value.
TCP Timeout (Seconds)	This parameter is used to configure the TCP timeout value. If Modbus TCP communication is idle for a specific time, the system will cut off the connection.
UDP Configuration	This parameter is used to enable or disable the UDP configuration function.
Web Auto-logout	This parameter is used to configure the automatic logout value. If there is no activity on the web server for a specific time, the current user account will automatically be logged out.
Alias Name	This parameter is used to assign an alias name for each ET-2200 module to assist with easy identification.
HTTP Port	This parameter is used to assign specific a HTTP port to the ET-2200 module. The ET-2200 needs to be restarted when the HTTP port is changed. You need manually type the new HTTP port in the address bar of the browser. The default is 80. For example, if the HTTP port is set to 81, then enter the "IP address: HTTP port" (10.0.8.123:81).
Update Settings	Click this button to save the revised settings to the ET-2200 module.

4.3.3 Restore Factory Defaults/Firmware Update

Other Operations

Restore all options to their factory default states	Restore Defaults
Reboot the module	Reboot
Firmware update via Ethernet If the remote firmware update is failed, then on-site firmware update is required to make the module working again. Step 1: Refer to firmware update manual first. Step 2: Run eSearch Utility to prepare and wait for update. Step 3: Click the [Update] button to reboot the module and start update. Step 4: Configure the module again.	Update

Note: This setup page may be different for some modules, but the functions are the same.

➤ **Restore all options to their factory default states**

To reset all parameters to their original factory default settings, use the following procedure:

- Step 1:** Click the “Restore Defaults” button to reset the configuration.
- Step 2:** Click the “OK” button in the message dialog box.
- Step 3:** Check whether the module has been reset to the original factory default settings for use with the **eSearch Utility**. Refer to [Section 3.3 “Configuring the Network Settings”](#).

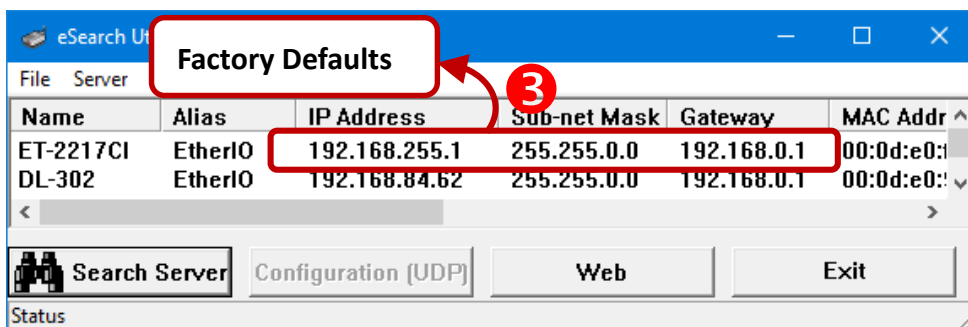
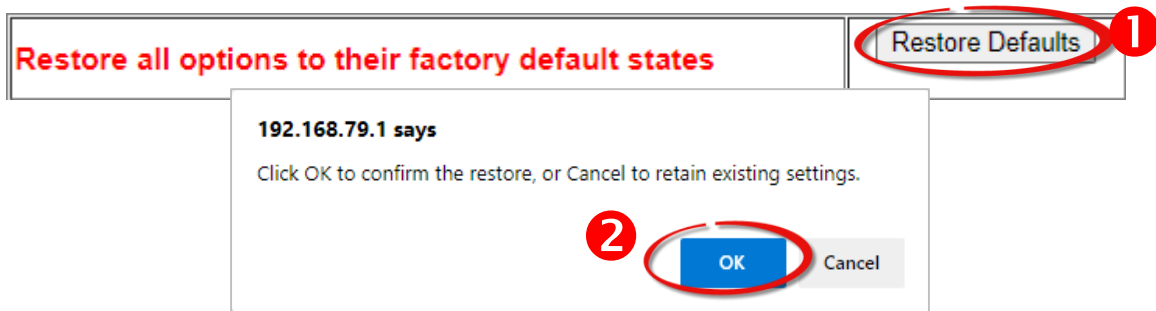

➤ **Reboot the module**

The **Reboot the module** function can be used to remotely force the ET-2200 module to reboot. After that, enter the password to log into the main page.

Other Operations

Restore all options to their factory default states	Restore Defaults
Reboot the module	Reboot

➤ **Firmware Update**

<p>Firmware update via Ethernet If the remote firmware update is failed, then on-site firmware update is required to make the module working again. Step 1: Refer to firmware update manual first. Step 2: Run eSearch Utility to prepare and wait for update. Step 3: Click the [Update] button to reboot the module and start update. Step 4: Configure the module again.</p>	<p>Update</p>
---	---------------

The firmware update requires initialization and local network operations. The traditional firmware update requires adjusting the Init/Run Switch and rebooting the module manually for the initialization of firmware update, while new firmware allows the user to initialize the module via web interface without adjusting the hardware switch. Initialization via the web is useful when a module is installed in a remote field and can be accessed by a remote PC via TeamViewer.

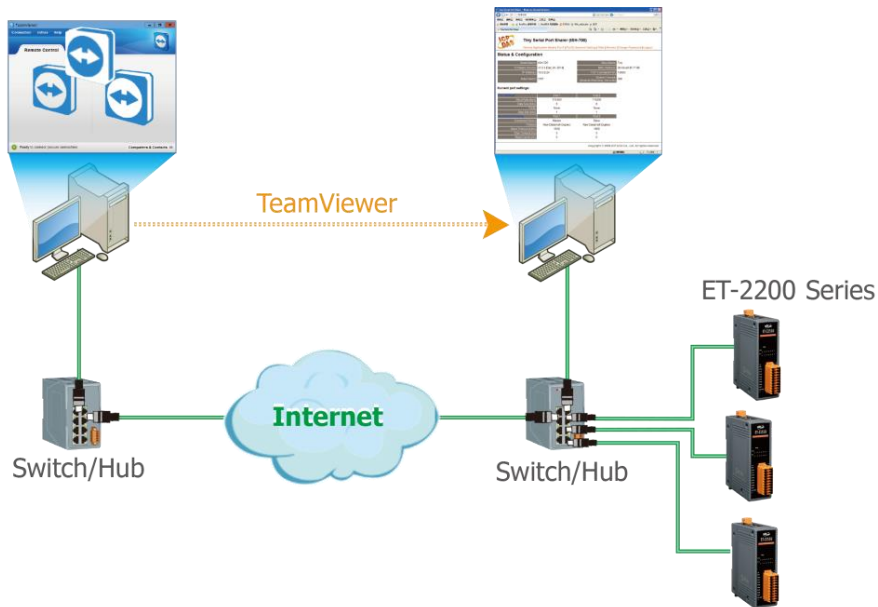

Note:

If the remote firmware update fails, the module will not function properly. Please perform the traditional firmware update again and then the module will work normally.

For detailed information about how to remotely update the Firmware for the ET-2200 module, refer to the **ET-2200 Firmware Update Manual (EN)**. The download address is shown below:



<https://www.icpdas.com/en/download/show.php?num=2626>

4.4 I/O Settings

The **I/O Settings** page allows you to configure the Digital Input, Digital Output, and Analog Input parameters for the ET-2200 series module.

Section	DI	DO	AI	AO
4.4.1 DO Control	-	✓	-	-
4.4.2 DI/DO Configuration		✓	-	-
4.4.3 Analog Input Channel	-		✓	-
4.4.4 Analog Input Calibration	-		ET-2217CI, ET-2217CI-4	-
4.4.5 Analog Output Configuration	-		-	✓
4.4.5 RTC	-		✓	-
4.4.6 Data Logger	-		✓	-

4.4.1 DO Control

Ethernet I/O Module
[Home](#) | [Network](#) | [I/O Settings](#) | [Sync](#) | [PWM](#) | [Pair](#) | [Filter](#) | [Monitor](#) | [Password](#) | [Logout](#)
 MQTT (Topics: [DO](#) | [DI](#))

Digital Output	Modbus Address	Setting
Value	00007 - 00000	0x0 (CH 7 - 0: <input type="checkbox"/> <input type="checkbox"/> <input type="checkbox"/> <input type="checkbox"/> <input type="checkbox"/> <input type="checkbox"/> <input type="checkbox"/>)
<input type="button" value="Update Settings"/>		

The table describes the parameters contained in the "**DO Control**" section.

Item	Description
Set DO value	This parameter is used to manually assign a specific value for the DO.
Update Settings	Click this button to save the revised settings to the ET-2200 module.

4.4.2 DI/DO Configuration

DI/DO Configuration:

Digital Output	Modbus Address	Setting
Host/Slave Watchdog Timeout	40257	<input type="text" value="0"/> (10 ~ 65000 Seconds, Default= 0, Disable= 0) Outputs DO with safe-value or <i>PWM</i> when host/slave timeout.
Enable Safe Value (Enable Watchdog)	00339 - 00332	<input type="text" value="0x0"/> (CH 7 - 0: <input type="checkbox"/> <input type="checkbox"/> <input type="checkbox"/> <input type="checkbox"/> . <input type="checkbox"/> <input type="checkbox"/> <input type="checkbox"/> <input type="checkbox"/>)
Safe Value	00274 - 00267	<input type="text" value="0x0"/> (CH 7 - 0: <input type="checkbox"/> <input type="checkbox"/> <input type="checkbox"/> <input type="checkbox"/> . <input type="checkbox"/> <input type="checkbox"/> <input type="checkbox"/> <input type="checkbox"/>)
Power-On Value	00242 - 00235	<input type="text" value="0x0"/> (CH 7 - 0: <input type="checkbox"/> <input type="checkbox"/> <input type="checkbox"/> <input type="checkbox"/> . <input type="checkbox"/> <input type="checkbox"/> <input type="checkbox"/> <input type="checkbox"/>)
Digital Input	Modbus Address	Setting
Enable Latched DI	00150	<input type="checkbox"/> (Enable All = Checked)
Clear Latched Status (High)	00032	<input type="checkbox"/> (Clear High = Checked)
Clear Latched Status (Low)	00033	<input type="checkbox"/> (Clear Low = Checked)
DI Filter Level	40201	<input type="text" value="0"/> (1 ~ 6000 ms, Default= 0, Disable= 0)
Digital Counter	Modbus Address	Setting (Based on DI)
Enable Digital Counter	00158 - 00151	<input type="text" value="0x0"/> (CH 7 - 0: <input type="checkbox"/> <input type="checkbox"/> <input type="checkbox"/> <input type="checkbox"/> . <input type="checkbox"/> <input type="checkbox"/> <input type="checkbox"/> <input type="checkbox"/>)
Clear Digital Counter	00041 - 00034	<input type="text" value="0x0"/> (CH7 - 0: <input type="checkbox"/> <input type="checkbox"/> <input type="checkbox"/> <input type="checkbox"/> . <input type="checkbox"/> <input type="checkbox"/> <input type="checkbox"/> <input type="checkbox"/>)
Preset Counter Value	40065 - 40050	Ch 07: <input type="text" value="0"/> Ch 06: <input type="text" value="0"/> Ch 05: <input type="text" value="0"/> Ch 04: <input type="text" value="0"/> Ch 03: <input type="text" value="0"/> Ch 02: <input type="text" value="0"/> Ch 01: <input type="text" value="0"/> Ch 00: <input type="text" value="0"/>
Frequency Measurement	Modbus Address	Setting (Based on DI)
Enable Frequency Measurement	00197 - 00190	<input type="text" value="0x0"/> (CH 7 - 0: <input type="checkbox"/> <input type="checkbox"/> <input type="checkbox"/> <input type="checkbox"/> . <input type="checkbox"/> <input type="checkbox"/> <input type="checkbox"/> <input type="checkbox"/>)
Scan Mode	40150	Single pulse ▼ 1000 ms: 1 Hz ~ 3 kHz (+/- 1 Hz error). 100 ms: 100 Hz to 3 kHz (+/- 10 Hz error). Single-pulse: 0.01 Hz ~ 1 Hz (+/- 0.01 Hz error), for stable signal only. Note: ET-2254P supports counter/frequency up-to 2.5 kHz.
Moving Average	40200	<input type="text" value="1"/> ▼
Universal DIO	Modbus Address	Setting (for ET-2254/P Only)
Configuration Mode	00299	Dynamic ▼ Static: By "Force DI/DO Mode" configuration. Dynamic: Depends on DO requests.
Force DI/DO Mode	00307 - 00300	<input type="text" value="0x0"/> (CH 7 - 0: <input type="checkbox"/> <input type="checkbox"/> <input type="checkbox"/> <input type="checkbox"/> . <input type="checkbox"/> <input type="checkbox"/> <input type="checkbox"/> <input type="checkbox"/>) 0=DO, 1=DI

The table describes the parameters contained in the "DI/DO Configuration" section.

Item	Description
Digital Output	
Host/Slave Watchdog Timeout	This parameter is used to configure the Host Watchdog timeout value. If there is no Modbus TCP communication activity for the specified period (the timeout), then the Host Watchdog will activate an alarm.
Enable Safe Value (Enable Watchdog)	This parameter is used to enable the watchdog on each DO channel.

Item	Description
Safe Value	This parameter is used to define the DO safe value for the ET-2200 module. If the Host Watchdog alarm is activated, the DO will be set to the user-defined safe value.
Power-On Value	This parameter is used to define the DO Power-on value. On boot-up, the DO is set to the user-defined Power-on value.
Digital Input	
Enable Latched DI	This parameter is used to enable the latch function on all DI channels. The status of the DI will be recorded if it has been flagged as either high or low. 0 = Disable All; 1 = Enable All
Clear Latched Status (High)	This parameter is used to clear the status of all high-latched D/I. 0 = No Operation; 1 = Clear All
Clear Latched Status (Low)	This parameter is used to clear the status of all low-latched D/I. 0 = No Operation; 1 = Clear All
DI Filter Level	The DI filter is a function that eliminates high-frequency noise from inputs. Settings range value: 1 ~ 6500 (ms); 0 = Disable (Default). Refer to Appendix A.4 "What is Digital-Input Filter (DI Filter)" for more details.
Digital Counter	
Enable Digital Counter	This parameter is used to enable the digital counter on each DI channel.
Clear Digital Counter	This parameter is used to clear the values of each DI counter.
Preset Counter Value	This parameter is used to set the default value for each DI counter.
Frequency Measurement (DI)	
Enable Frequency Measurement	This parameter is used to enable the frequency measurement function on each DI channel.

Item	Description
Scan Mode	<p>This parameter is used to define the scan mode for the frequency measurement.</p> <p>1000 ms: This mode provides a normal update rate and normal accuracy. The acceptable frequency range for the input signal is 1 Hz to 3 kHz (± 1 Hz error). This mode can be used when the pulse width (signal source) contains small errors since the measurement is based on the pulse count.</p> <p>100 ms: This mode provides a fast update rate, but the accuracy is low. The acceptable frequency range for the input signal is 100 Hz to 3 kHz (± 10 Hz error). This mode can be used when the pulse width (signal source) contains small errors since the measurement is based on the pulse count.</p> <p>Single-pulse: This mode provides the highest accuracy but can only be used for a stable signal. The data update rate depends on the signal frequency and the acceptable signal frequency range for the input signal is 0.01 Hz to 3.5 kHz (± 0.01 Hz error). This mode can only be used when the pulse width (signal source) is stable since the measurement is based on the width of a single pulse.</p>
Moving Average	<p>1 ==> No Average is used 2 ==> Uses the average of 2 continuous sample values 4 ==> Uses the average of 4 continuous sample values 8 ==> Uses the average of 8 continuous sample values</p>
Universal DIO	
Force DI/DO Mode For ET-2254(P) only	<p>Dynamic: Dynamic I/O type based on DO requests.</p> <p>Static: Static I/O type by configuration (web or Modbus).</p> <div style="border: 1px solid black; padding: 5px; width: fit-content; margin: 10px auto;"> <input type="text" value="0x0"/> (CH 7 - 0: <input type="checkbox"/> <input type="checkbox"/> <input type="checkbox"/> <input type="checkbox"/> . <input type="checkbox"/> <input type="checkbox"/> <input type="checkbox"/> <input type="checkbox"/>) 0=DO, 1=DI </div> <p>This parameter is used to set the Universal DIO channels to DI or DO Port. 1 ==> DI; 0 ==> DO</p>
Update Settings	Click this button to save the revised settings to the ET-2200 module.

4.4.3 Analog Input Configuration

Note: The content in Sections 4.4.3 to 4.4.6 is available for some of the AI modules.

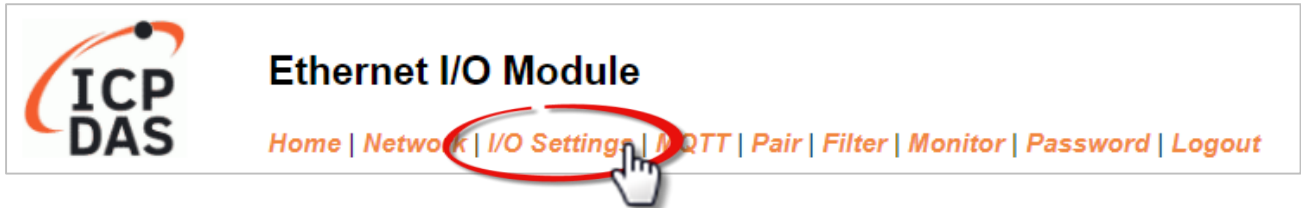

Note that some of the modules support the alarm function.

AI Channel	Type (40427~434)	Channel Enable (00595~602)	Hi Alarm Enable (00636~643)	Hi Alarm Mode (00700~707)	Hi Alarm Value (40296~303)	Low Alarm Enable (00668~675)	Low Alarm Mode (00732~739)	Low Alarm Value (40328~335)
AI0:	0x07.4~20mA	Disabled	Disabled	Momentary	0.000	Disabled	Momentary	0.000
AI1:	0x07.4~20mA	Disabled	Disabled	Momentary	0.000	Disabled	Momentary	0.000
AI2:	0x07.4~20mA	Disabled	Disabled	Momentary	0.000	Disabled	Momentary	0.000
AI3:	0x07.4~20mA	Disabled	Disabled	Momentary	0.000	Disabled	Momentary	0.000
AI4:	0x07.4~20mA	Disabled	Disabled	Momentary	0.000	Disabled	Momentary	0.000
AI5:	0x07.4~20mA	Disabled	Disabled	Momentary	0.000	Disabled	Momentary	0.000
AI6:	0x07.4~20mA	Disabled	Disabled	Momentary	0.000	Disabled	Momentary	0.000
AI7:	0x07.4~20mA	Disabled	Disabled	Momentary	0.000	Disabled	Momentary	0.000
Modbus Format	Hexadecimal	Action: Modbus Read/Write Format Hexadecimal or Engineering						
Sampling Rate	Normal	Action: AI Sampling Rate setting						
Analog Input Mode	Differential	Action: Analog Input Mode Differential or Single End						
Update Settings								

The table describes the parameters contained in the "Analog Input Configuration" section.

Item	Description
Analog Input Channel	
AI0 ~ AI7	Set the data range for each channel and whether to enable or disable it. If the alarm is enabled and the alarm mode is set to "Momentary" which means the alarm status will automatically be cleared if the alarm occurred and the AI value is back to normal. If the mode is set to "Latch", the alarm status can only be cleared by using the Clear command.
Analog Input	
Data Format	Set the data format, e.g., Hex or Engineering.
Sampling Rates	Set the sampling rate, e.g., 10 Hz or 200 Hz.
Analog Input Mode	Set the wiring mode, e.g., Differential or Single End.
Update Settings	Click this button to save the revised settings to the ET-2200 module.

4.4.4 Analog Input Calibration

Analog Input Calibration

Analog Input Channel	Range	Zero Calibration Voltage/Current	Span Calibration Voltage/Current
AI0	05: +/-2.5 V	0 V	+2.5 V
AI1	06: +/-20 mA	0 mA	+20 mA
AI2	07: +4 mA to +20 mA	0 mA	+20 mA
AI3	08: +/-10 V	0 V	+10 V
AI4	09: +/-5 V	0 V	+5 V
AI5	0A: +/-1 V	0 V	+1 V
AI6	0D: +/-20 mA	0 mA	+20 mA
AI7	1A: 0 mA to +20 mA	0 mA	+20 mA
AI Channel	AI0 ▾	Type	Zero ▾
<input type="button" value="Calibrate"/>			
Reload Factory Calibration Parameters		<input type="button" value="Reload"/>	

The table describes the parameters contained in the "Analog Input Calibration" section.

Item	Description
Analog Input Channel	
AI0 ~ AI7	Display the data range and the Zero or Span calibration voltage/current.
AI Channel	Select an AI channel to perform calibration.
Type	Select the type of calibration, e.g., Zero or Span.
Calibrate	Click the Calibrate button to perform calibration

➤ Reload Factory Calibration Parameters

Follow the steps to load the factory default settings.

Step 1: Click the "Reload" button to load the calibration parameters.

Step 2: Click the "OK" button in the dialog box to complete the setting.

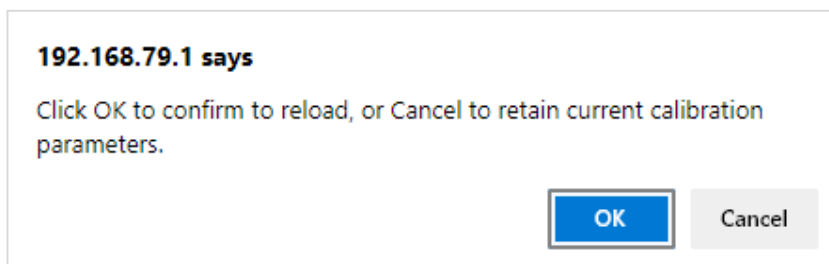

4.4.5 RTC

The function is used to set the system time and click the “Update Settings” button to save the revised settings to the ET-2200 module.

RTC	
Year	<input type="text" value="2022"/> (2000 to 2159)
Month	<input type="text" value="6"/> (1 to 12)
Date	<input type="text" value="13"/> (1 to 31)
Hour	<input type="text" value="11"/> (0 to 23)
Minute	<input type="text" value="5"/> (0 to 59)
Second	<input type="text" value="50"/> (0 to 59)
<input type="button" value="Update Settings"/>	

4.4.6 Data Logger

Data Logger	
Status	Running
Change Logging	<input type="text" value="Run"/>
Overwrite on Full	<input type="text" value="No"/>
Sampling Interval - Second	<input type="text" value="1"/> (0 to 65535)
Sampling Interval - Millisecond	<input type="text" value="0"/> (0 to 1000, in 5 ms step)
Period Start - Year	<input type="text" value="2021"/> (2000 to 2159)
Period Start - Month	<input type="text" value="9"/> (1 to 12)
Period Start - Date	<input type="text" value="6"/> (1 to 31)
Period Start - Hour	<input type="text" value="11"/> (0 to 23)
Period Start - Minute	<input type="text" value="30"/> (0 to 59)
Period Start - Second	<input type="text" value="0"/> (0 to 59)
Period End - Year	<input type="text" value="2021"/> (2000 to 2159)
Period End - Month	<input type="text" value="9"/> (1 to 12)
Period End - Date	<input type="text" value="6"/> (1 to 31)
Period End - Hour	<input type="text" value="17"/> (0 to 23)
Period End - Minute	<input type="text" value="0"/> (0 to 59)
Period End - Second	<input type="text" value="0"/> (0 to 59)
<input type="button" value="Update Settings"/>	
<input type="button" value="Reset data logger to empty"/> <input type="button" value="Reset Data Logger"/>	

The table describes the parameters contained in the "**Data Logger**" section.

Item	Description
Status	Display the current status of data logging.
Change Logging	Set the status of data logging. It can be set to Stop, Run, Period, Pause, and Continue.
Overwrite on Full	Whether to overwrite data when it is full. It can be set to Yes or No.
Sampling Interval - Second	The time interval for logging data. (Range: 0-65535, Unit: second)
Sampling Interval - Millisecond	The time interval for logging data. (Range: 0-1000, in 5 ms step)
Period Start- Year, Month, Date, Hour, Minute, Second	The start time for logging data. (Year/Month/Date/Hour/Minute/ Second).
Period End- Year, Month, Date, Hour, Minute, Second	The end time for logging data. (Year/Month/Date/Hour/Minute/ Second).

➤ **Reset data logger to empty**

Click the "Reset Data Logger" button to remove data.

4.4.7 Analog Output Configuration

Analog Output Configuration

AO Channel	Type (40459~466)	Power On Value (40360~367)	Safe Value (40392~399)	Slew Rate (40523~530)
AO0:	0x30: 0 ~ 20mA	0.000	0.000	0x00:Immediate
AO1:	0x30: 0 ~ 20mA	0.000	0.000	0x00:Immediate
AO2:	0x30: 0 ~ 20mA	0.000	0.000	0x00:Immediate
AO3:	0x30: 0 ~ 20mA	0.000	0.000	0x00:Immediate
AO4:	0x30: 0 ~ 20mA	0.000	0.000	0x00:Immediate
AO5:	0x30: 0 ~ 20mA	0.000	0.000	0x00:Immediate
AO6:	0x30: 0 ~ 20mA	0.000	0.000	0x00:Immediate
AO7:	0x30: 0 ~ 20mA	0.000	0.000	0x00:Immediate
Modbus Format	Hexadecimal	Action: Modbus Read/Write Format Hexadecimal or Engineering		
Host Timeout (Safe Value/Enable, Seconds)	0	(10 ~ 65000 s, 0 = Default Disabled) Action:AO Output Safe Value		

Note: Above Modbus addresses are all 0 based.

The table describes the parameters contained in the "Analog Output Calibration" section.

Item	Description
AO Channel	
AO0 ~ AO7	Set the data type, Power-on value, Safe value, and Slew Rate for each channel.
Modbus Format	Set the data format. It can be Hexadecimal or Engineering
Host Timeout	This parameter is used to configure the Host Watchdog timeout value. If there is no Modbus TCP communication activity for the specified period (the timeout), the AO will be set to the user-defined safe value.
Update Settings	Click this button to save the revised settings to the ET-2200 module.

4.5 Sync

Note: The function is available for **DIO** modules.

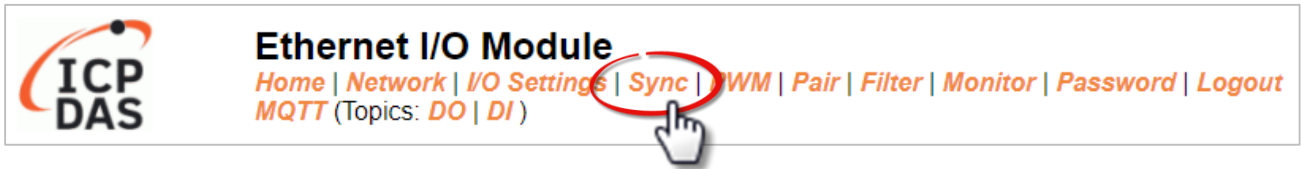

The **DIO Synchronization** section on the **Sync** page allows you to configure the Synchronous DIO, Min-switching time of DO, and Auto-off Time of DO for the ET-2200 series module, each of which will be described in more detail below.

4.5.1 DIO Synchronization

DIO Synchronization

Synchronous DIO (Local Mirror)	Modbus Address	Setting
Level Sync (DO=DI)	00403 - 00396	<input type="text" value="0x0"/> (CH 7 - 0: <input type="checkbox"/> <input type="checkbox"/> <input type="checkbox"/> <input type="checkbox"/> <input type="checkbox"/> <input type="checkbox"/> <input type="checkbox"/> <input type="checkbox"/>) Set the DO state to the same as the DI state.
Rising Active (DO=ON)	00419 - 00412	<input type="text" value="0x0"/> (CH 7 - 0: <input type="checkbox"/> <input type="checkbox"/> <input type="checkbox"/> <input type="checkbox"/> <input type="checkbox"/> <input type="checkbox"/> <input type="checkbox"/> <input type="checkbox"/>) Turn ON DO when DI is changed from OFF to ON.
Falling Active (DO=ON)	00435 - 00428	<input type="text" value="0x0"/> (CH 7 - 0: <input type="checkbox"/> <input type="checkbox"/> <input type="checkbox"/> <input type="checkbox"/> <input type="checkbox"/> <input type="checkbox"/> <input type="checkbox"/> <input type="checkbox"/>) Turn ON DO when DI is changed from ON to OFF.
Additional Controls	Modbus Address	Setting
Min-Switching Time of DO (0 to 65000 Seconds)	40283 - 40268	DO 15: <input type="text" value="0"/> DO 14: <input type="text" value="0"/> DO 13: <input type="text" value="0"/> DO 12: <input type="text" value="0"/> DO 11: <input type="text" value="0"/> DO 10: <input type="text" value="0"/> DO 09: <input type="text" value="0"/> DO 08: <input type="text" value="0"/> DO 07: <input type="text" value="0"/> DO 06: <input type="text" value="0"/> DO 05: <input type="text" value="0"/> DO 04: <input type="text" value="0"/> DO 03: <input type="text" value="0"/> DO 02: <input type="text" value="0"/> DO 01: <input type="text" value="0"/> DO 00: <input type="text" value="0"/>
		DO 15: <input type="text" value="0"/> DO 14: <input type="text" value="0"/> DO 13: <input type="text" value="0"/> DO 12: <input type="text" value="0"/> DO 11: <input type="text" value="0"/> DO 10: <input type="text" value="0"/> DO 09: <input type="text" value="0"/> DO 08: <input type="text" value="0"/> DO 07: <input type="text" value="0"/> DO 06: <input type="text" value="0"/> DO 05: <input type="text" value="0"/> DO 04: <input type="text" value="0"/> DO 03: <input type="text" value="0"/> DO 02: <input type="text" value="0"/> DO 01: <input type="text" value="0"/> DO 00: <input type="text" value="0"/>
Auto-off Time of DO (0 to 65000 Seconds)	40299 - 40284	DO 15: <input type="text" value="0"/> DO 14: <input type="text" value="0"/> DO 13: <input type="text" value="0"/> DO 12: <input type="text" value="0"/> DO 11: <input type="text" value="0"/> DO 10: <input type="text" value="0"/> DO 09: <input type="text" value="0"/> DO 08: <input type="text" value="0"/> DO 07: <input type="text" value="0"/> DO 06: <input type="text" value="0"/> DO 05: <input type="text" value="0"/> DO 04: <input type="text" value="0"/> DO 03: <input type="text" value="0"/> DO 02: <input type="text" value="0"/> DO 01: <input type="text" value="0"/> DO 00: <input type="text" value="0"/>
<input type="button" value="Update Settings"/>		

The table describes the parameters contained in the "**DIO Synchronization**" section.

Item	Description
Synchronous DIO (Local Mirror) Note: ET-2254 supports these functions when low 8-bit is DI0 to DI7 and high 8-bit is DO8 to DO15.	
Level Sync (DO = DI)	This parameter is used to enable the synchronization operation in Digital Input/Output function.
Rising Active (DO = ON)	This parameter is used to enable rising activation in the Digital Input function. When the specified DI state changes from OFF to ON, the corresponding DO will be set to ON.
Falling Active (DO = ON)	This parameter is used to enable falling activation in the Digital Input function. When the specified DI state changes from ON to OFF, the corresponding DO will be set to ON.
Additional Controls	
Min-Switch Time of DO (0 to 65535 Seconds)	This parameter is used to set the minimum switching time between the ON and OFF states of the Digital Output. This protects some machines from being damaged by too many ON/OFF switches in a short time.
Auto-off Time of DO (0 to 65535 Seconds)	This parameter is used to set the auto-off time of the Digital Output. If the Digital Output is ON, the Digital Output will be auto-off based on the configured time value.
Update Settings	Click this button to save the revised settings of the DIO configuration to the ET-2200 module.

4.6 PWM

Note: The function is available for **DIO** modules.



The **PWM Configuration** section on the **PWM** page allows you to enable and configure the PWM parameters for the ET-2200 series module, including the PWM Alarm and duty cycle, etc., each of which will be described in more detail below.

Note: Because of the characteristics of the relay functions, it is recommended that the PWM on the ET-2260/2261/2268 module (i.e., modules with relay functions) is not used for extended periods.

4.6.1 PWM Configuration

PWM Configuration:

PWM Functions	Modbus Address	Setting
Enable PWM	00107 - 00100	0x0 (CH 7 - 0: <input type="checkbox"/> <input type="checkbox"/> <input type="checkbox"/> <input type="checkbox"/> <input type="checkbox"/> <input type="checkbox"/> <input type="checkbox"/> <input type="checkbox"/>)
Enable PWM Alarm	00371 - 00364	0x0 (CH 7 - 0: <input type="checkbox"/> <input type="checkbox"/> <input type="checkbox"/> <input type="checkbox"/> <input type="checkbox"/> <input type="checkbox"/> <input type="checkbox"/> <input type="checkbox"/>) (Activates the PWM/DO outputs when Host/Slave Watchdog Timeout)
Duty Cycle	40115 - 40100	DO 07: (<input type="text" value="0"/> , <input type="text" value="0"/>) DO 06: (<input type="text" value="0"/> , <input type="text" value="0"/>) DO 05: (<input type="text" value="1000"/> , <input type="text" value="1000"/>) DO 04: (<input type="text" value="1000"/> , <input type="text" value="1000"/>) DO 03: (<input type="text" value="1000"/> , <input type="text" value="1000"/>) DO 02: (<input type="text" value="1000"/> , <input type="text" value="1000"/>) DO 01: (<input type="text" value="1000"/> , <input type="text" value="1000"/>) DO 00: (<input type="text" value="1000"/> , <input type="text" value="1000"/>) (High, Low: 10 ~ 65000 ms, 0= Disable)
<input type="button" value="Update Settings"/>		

The table describes the parameters contained in the "PWM Configuration" section.

Item	Description	Defaults
Enable PWM	This parameter is used to enable the PWM output function.	0
Enable PWM Alarm	This parameter is used to enable the PWM output alarm function when the Host/Slave watchdog timeout.	0
Duty Cycle	This parameter is used to set the duty cycle for the DO channels. Two values are required for each DO channel. The first value is the high pulse width, while the second is the low pulse width. The duty cycle is in 1 ms units, and the resolution is approximately 5 ms. (10 to 65535 ms). A value of 0 will disable the duty cycle functions for that channel.	1000 (ms)
Update Settings	Click this button to save the revised settings to the ET-2200 module.	

4.7 MQTT (AI)

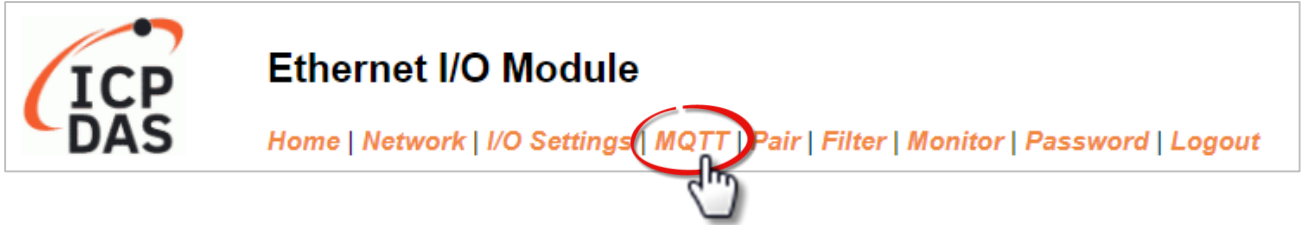

➤ **Connectivity Settings**

Refer to [Section 4.13.1 Connectivity Settings](#) for more details about the setting.

➤ **Publication Settings**

Refer to [Section 4.13.2 Publication Settings](#) for more details about the setting.

➤ **Analog Inputs**

Refer to [Section 4.16 MQTT-AI](#) for more details about the setting.

➤ **Restore Factory Defaults**

Refer to [Section 4.13.3 Restore Factory Defaults](#) for more details about the setting.

4.8 Pair Connection

Note: The function is available for AI/AO and DI/DO modules.

The **I/O Pair Connection Settings** section on the **Pair** page allows you to enable and configure the DI-to-DO pair connections for the ET-2200 series module via the Modbus TCP (Ethernet) protocol.

4.8.1 I/O Pair-Connection Settings

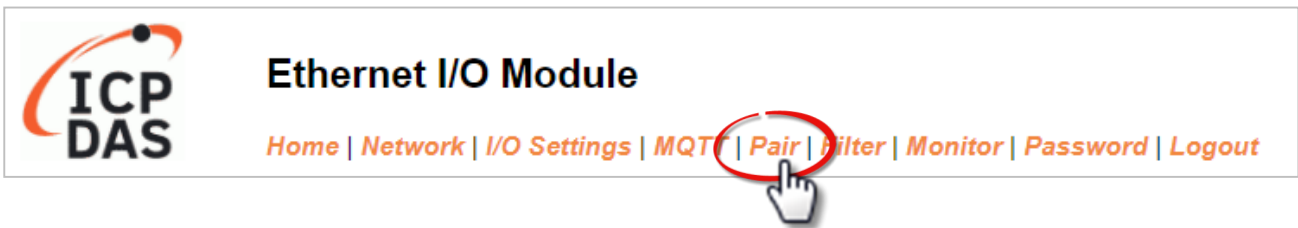

Note: These screens may be different according to the model.

Pair-Connection Settings:

PULL Mode: (Remote AI -> Local AO)

PUSH Mode: (Local AI -> Remote AO)

| 1~5 | 6~10 | 11~12 |

#	Mode	Remote IP	Remote Port	Net ID	Scan Time	AI Count	AI Addr	AO Addr	TCP/UDP	Update
01	Disable ▾	0 . 0 . 0 . 0	502	1	1000 ms	0	0	0	TCP ▾	Submit
02	Disable ▾	0 . 0 . 0 . 0	502	1	1000 ms	0	0	0	TCP ▾	Submit
03	Disable ▾	0 . 0 . 0 . 0	502	1	1000 ms	0	0	0	TCP ▾	Submit
04	Disable ▾	0 . 0 . 0 . 0	502	1	1000 ms	0	0	0	TCP ▾	Submit
05	Disable ▾	0 . 0 . 0 . 0	502	1	1000 ms	0	0	0	TCP ▾	Submit

AI/AO - Screen01

Pair-Connection Settings:

| Submit 1-4 | 5-8 |

#	Enable Mode	Remote IPv4 / IPv6 / Host Name (Max. 127 chars)	Remote Port	Net ID	Scan Time (ms)	AI Address	AO Address	Network Protocol
01	<input type="checkbox"/> PULL ▾	0.0.0.0	502	1	1000	0	0	TCPv4 ▾
02	<input type="checkbox"/> PULL ▾	0.0.0.0	502	1	1000	0	0	TCPv4 ▾
03	<input type="checkbox"/> PULL ▾	0.0.0.0	502	1	1000	0	0	TCPv4 ▾
04	<input type="checkbox"/> PULL ▾	0.0.0.0	502	1	1000	0	0	TCPv4 ▾

Note:
Only Support TCP PULL Mode = Remote AI to Local AO. Data Format must be Engineering

AI/AO - Screen02

Ethernet I/O Module

[Home](#) | [Network](#) | [I/O Settings](#) | [Sync](#) | [PWM](#) | [Pair](#) | [Filter](#) | [Monitor](#) | [Password](#) | [Logout](#)
[MQTT](#) (Topics: [DO](#) | [DI](#)) | [SNMP](#)

DI/DO Screen-

Pair-Connection Settings: | Submit 1-8 | 9-16 |

#	Enable Mode	Remote IPv4 / IPv6 / Host Name (Max. 127 chars) : Port	Net ID	Scan Time (ms)	IO Count	Local IO Address	Remote IO Address	Network Protocol
01	<input type="checkbox"/> PUSH	502	1	1000	1	0x:Coil 0 0	0x:Coil 0 0	TCPv4
02	<input type="checkbox"/> PULL	502	1	1000	1	0x:Coil 0 0	0x:Coil 0 0	TCPv4
03	<input type="checkbox"/> PULL	502	1	1000	1	0x:Coil 0 0	0x:Coil 0 0	TCPv4
04	<input type="checkbox"/> PULL	502	1	1000	1	0x:Coil 0 0	0x:Coil 0 0	TCPv4
05	<input type="checkbox"/> PULL	502	1	1000	1	0x:Coil 0 0	0x:Coil 0 0	TCPv4
06	<input type="checkbox"/> PULL	502	1	1000	1	0x:Coil 0 0	0x:Coil 0 0	TCPv4
07	<input type="checkbox"/> PULL	502	1	1000	1	0x:Coil 0 0	0x:Coil 0 0	TCPv4
08	<input type="checkbox"/> PULL	502	1	1000	1	0x:Coil 0 0	0x:Coil 0 0	TCPv4

Note:
 PULL Mode = Remote to Local
 PUSH Mode = Local to Remote
 Pair-connection is disabled if the IO Count is 0 (no data)
 IO Address (base 0): 0 - 65535, no leading 0x/1x/3x/4x.

The table describes the parameters contained in the "I/O Pair-Connection Settings" section.

Item	Description	Defaults
Mode	Enabling or disabling the Client (Master) function of the ET-2200 module and selecting either PULL or PUSH mode. PULL: To read the remote AI (or DI) and write to the local AO (or DO). PUSH: To read the local AI (or DI) and write to the remote AO (or DO).	Disable
Remote IP	Set the IP address or the hostname of the remote device. Note that the user needs to set the correct DNS on the Network page before setting the hostname.	0
Remote Port	Set the TCP port number of the remote device. The valid range is 0 - 65535.	502
Net ID	Set the Modbus Net ID of the remote device. The valid range is 1 - 247.	1

Item	Description	Defaults
Scan Time	<p>In "PULL" mode, the module will update the IO data according to the specified Scan Time. If there is no response from the Slave over the scan time, it is determined as Timeout.</p> <p>In "PUSH" mode, the module will update the remote AO (DO) data when the local AI (DI) data is changed. If the local AI (DI) data does not change during the specified Scan Time, the module will still forcefully update the data to the remote AO (DO).</p> <p>The valid range is 1000 to 42949672965 (ms)</p>	1000 ms
IO Count (AI Count)	This parameter specifies how many I/O channels are mapped. (0= Disable)	0
Local IO Address (AI Address)	<p>This parameter is used to select the local IO type and the start address.</p> <p>Shared memory is only available for DIO series modules: The DIO (Bit) address ranges from 3000 to 7094 The AIO (Register) address ranges from 3000 to 3254</p> <p>DI, DO, AI, and AO data share the same memory block. If different IO data are written to the same address, the data will overwrite each other.</p>	0
Remote IO Address (AO Address)	This parameter is used to select the remote IO type and the start address.	0
TCP/UDP	This parameter is used to set the type of Modbus protocol to be used and can be TCPv4/TCPv6 or UDPv4/ UDPv6	TCP
Submit	Click the " Submit " button to save the revised settings to the ET-2200 module.	

4.9 Filter

Note: The function is available for AIO and DIO modules.

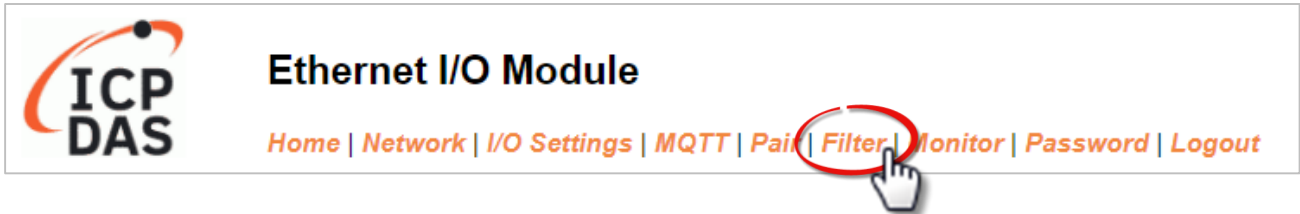

The **Filter Settings** section on the **Filter** page allows you to configure the IP Filter list for the ET-2200 series module, which will be described in more detail below.

4.9.1 Filter Settings

The **Filter Settings** function is used to query or set the IP Filter List (Available IP) for the ET-2200 series module. Only Clients whose IP address is specified in the list will be able to access the ET-2200 series module. Note that some of the modules do not support the IPv6 setting.

Filter Setting (disabled when all zero):

Accessible IP	IP Address
IP1	0.0.0.0
IP2	0.0.0.0
IP3	0.0.0.0
IP4	0.0.0.0
IP5	0.0.0.0

Add IPv4 To The List
 Add IPv6 To The List
 Delete IP#
 Delete ALL
 Save to Flash

The table describes the parameters contained in the "IP Address Configuration" section.

Item	Description
Add "IP" to the List	Used to add an IP address (IPv4 or IPv6) to the Available IP List.
Delete IP # "number"	Used to delete IP# address from the Available IP List.
Delete All	Used to delete all IP addresses currently contained in the Available IP List.
Save to Flash	Used to save the updated Available IP List to the Flash memory.
Submit	Click this button to save the revised settings to the ET-2200 module.

4.10 Monitor

Note: The function is available for AI/AO and DI/DO modules.

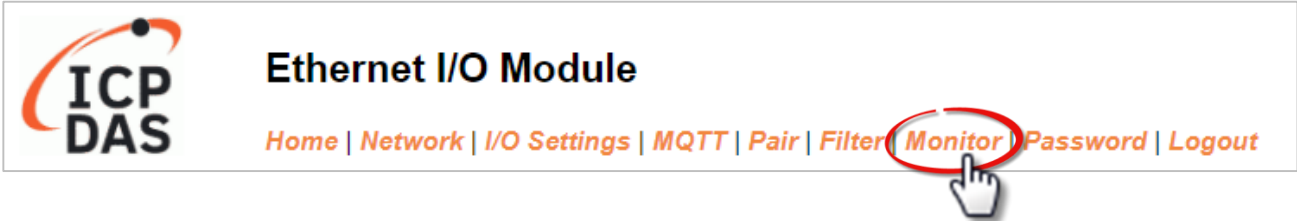

After clicking the **Monitor** tab, the user can check the connection status of the ET-2200 series module in the **Current Connection Status** section. Note that some of the modules only display IP addresses for the Server mode.

Current Connection Status:

Server Mode	Connected IP	Server Mode	Connected IP
IP1	-	IP2	-
IP3	-	IP4	-
IP5	-	IP6	-
IP7	-	IP8	-
IP9	-	IP10	-
IP11	-	IP12	-
Available Connections	32		

Client Mode	Remote IP	Connection State	Query State	Last Query Time	Host Name
IP1	-	-	-	-	-
IP2	-	-	-	-	-
IP3	-	-	-	-	-
IP4	-	-	-	-	-
IP5	-	-	-	-	-
IP6	-	-	-	-	-
Client Mode	Remote IP	Connection State	Query State	Last Query Time	Host Name
IP7	-	-	-	-	-
IP8	-	-	-	-	-
IP9	-	-	-	-	-
IP10	-	-	-	-	-
IP11	-	-	-	-	-
IP12	-	-	-	-	-

Item	Description
Server Mode (IP1 to IP12)	Display the connected IP address.
Available Connection	When used as a slave device, a maximum of 32 connections is allowed
Client Mode (IP1 to IP12)	Display the remote IP address, the connection state, the request state, the last query time, and the login hostname.

4.11 Change Password

Note: The function is available for AIO and DIO modules.

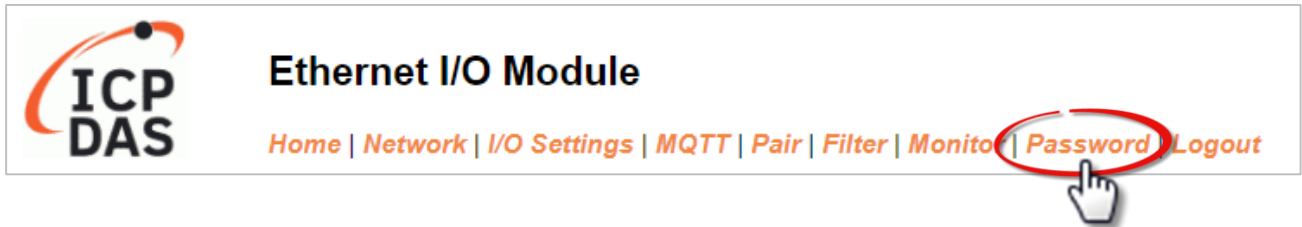

The **Password** page allows you to change the password that used to log in to ET-2200, follow the steps.

- Step 1: Enter the old password in the **“Current password”** field. The first time you change the password, enter the default password **“Admin”**.
- Step 2: Enter a new password in the **“New password”** field.
(please enter 1 to 12 digits of numbers or characters).
- Step 3: Re-enter the new password in the **“Confirm new password”** field.
- Step 4: Click the **“Submit”** button to update the password.

Change Password
The length of the password is 12 characters maximum.

Current password:	<input type="password" value="....."/>
New password:	<input type="password" value="...."/>
Confirm new password:	<input type="password" value="...."/>

 **Note:** If you forgot the password, refer to Appendix A1. How do I restore the web password for the module to the factory default password?

4.12 Logout

Note: The function is available for AIO and DIO modules.

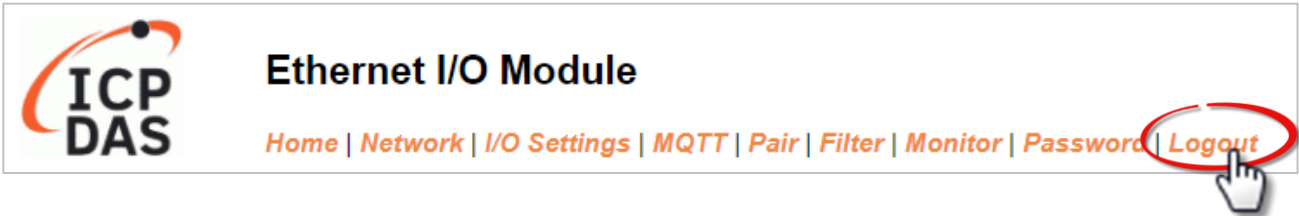

Clicking the **Logout** tab will immediately log out from the system and return to the login page.

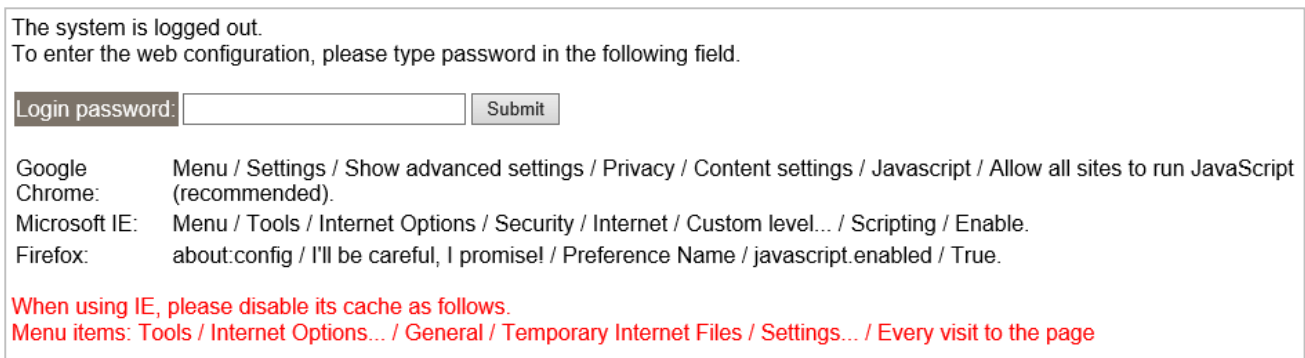

4.13 MQTT

Note: The function is available for **AI/AO** and **DI/DO** modules. But, ET-2217/2224/2228 does not support this function.

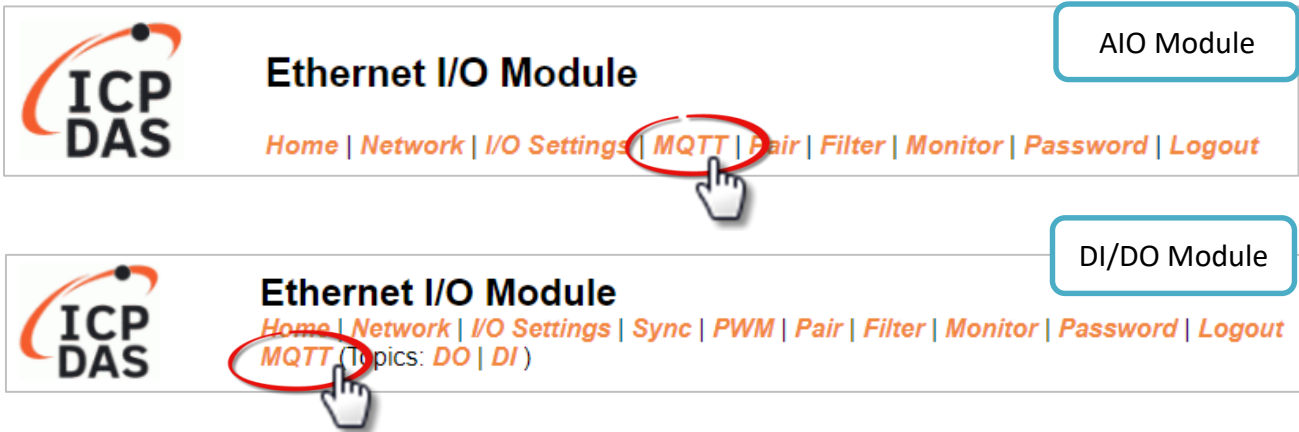

Chapter	DI	DO	AI	AO
4.13.1 Connectivity Settings	✓	✓	✓	✓
4.13.2 Publication Settings	✓	✓	✓	✓
4.13.3 Publication Settings	✓	✓	✓	✓
4.14 MQTT-DO	-	✓	-	-
4.15 MQTT-DI	✓	-	-	-
4.16 MQTT-AI	-	-	✓	-

MQTT is a Client Server Publish/Subscribe messaging transport protocol. It is simple, lightweight, and open, and is designed to be easy to implement. These characteristics make it ideal for use in many situations, including constrained environments such as for communication in Machine-to-Machine (M2M) and Internet of Things (IoT) contexts where a small code footprint is required and/or network bandwidth is at a premium.

MQTT is a protocol consisting of a Publish/Subscribe mechanism where the Client only needs to know the IP address of the Broker. The Broker then acts as a central location to handle the sending and receiving of all messages between a Publisher and a Subscriber. The Publisher is the entity that publishes the topic and message, the Subscriber is the entity that receives the updated messages from the Broker.

When the Publisher updates a message related to a specific topic, it is transmitted to the Broker, which will then send the message to all Subscribers that have subscribed to that particular topic. Neither the Publisher nor the Subscriber needs to know the status of the other.

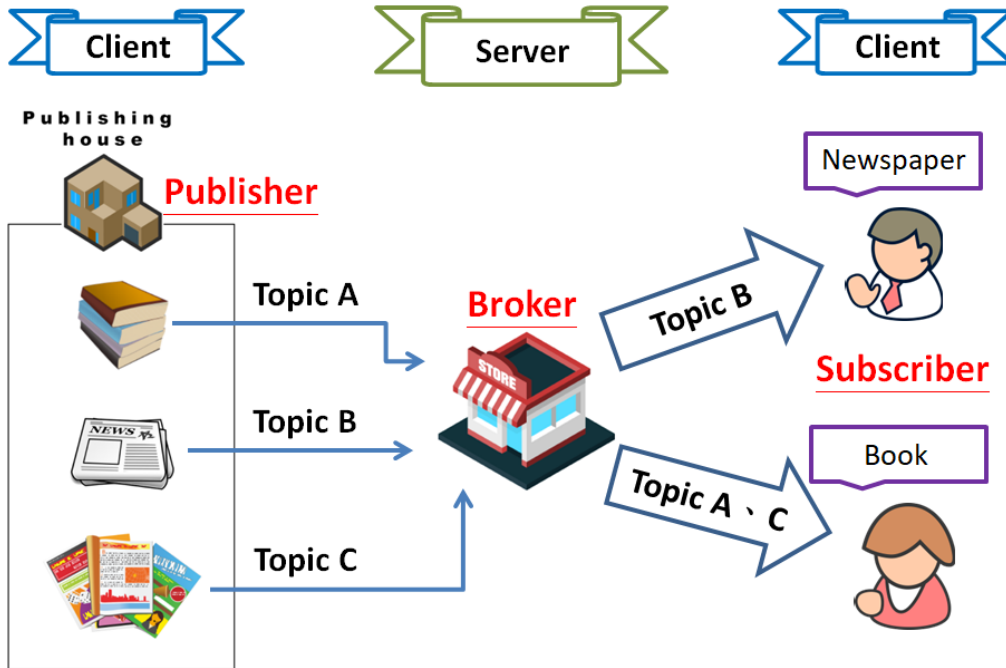

The above is a schematic diagram of the system. Publishers are similar to various forms of the publishing house and focus on updating commodities for different topics such as novels, newspapers, magazines, etc. Subscribers are similar to consumers, who purchase, or subscribe to designated commodities in a bookstore (Broker), which presents the latest information that has been designated by the Subscriber.

4.13.1 Connectivity Settings

Connectivity Settings

MQTT	Disable ▾	
Broker	<input checked="" type="radio"/> IP: 10 . 0 . 8 . 1	
	<input type="radio"/> Host Name (Max. 127 chars)	
Broker Port	1883	(Default= 1883)
Client Identifier	ET-2242U_E24203	
User Name	N/A	(Max. 63 chars)
Password	***	(Max. 63 chars)
Reconnection Interval	10	(5 ~ 65000 s, Default= 10)
Keep Alive Interval	20	(5 ~ 65000 s, Default= 20)
Main Topic Name	N/A (Max. 126 chars)	
Update Settings		

The table describes the parameters contained in the "**Connectivity Settings**" section.

Item	Description	Defaults
MQTT	Enables or Disables the MQTT connection function.	Disabled
Broker	The IP address or the Hostname for the MQTT broker.	N/A
Broker Port	The port number for the MQTT broker.	1883
Client Identifier	The client identifier uniquely identifies the MQTT client to the MQTT broker, and consists of the "module name" + "_" (underscore character) + "the last 6 digits of the MAC address" and cannot be changed.	
User Name	This parameter is used when the MQTT broker requires authentication. The length should be no more than 63 characters.	N/A
Password	This parameter is used when the MQTT broker requires authentication. The length should be no more than 63 characters.	N/A
Reconnection Interval	The time interval between attempts by the ET-2200 module to connect to the broker if a connection failure occurs. The valid range is 5 to 65000 seconds	10(s)
Keep Alive Interval	The keep-alive mechanism is provided to ensure that both the client and the broker are alive and the connection is still open. If a Client doesn't send any messages during the Keep Alive period, it must send a PINGREQ packet to the broker to confirm its availability. The broker must reply with a PINGRESP packet to also indicate its availability. The broker will disconnect a client, which doesn't send a PINGREQ packet or any other message within one and a half times of the Keep Alive Interval. The valid range is 5 to 65000 seconds.	20(s)
Main Topic Name	The Topic Name is a combination of the Main Topic Name and the Sub Topic Name. The Main Topic Name can be empty. The same part of the Topic Names can be entered in the Main Topic Name field to improve the processing efficiency of all Topic Names. A shorter Topic Name also improves processing efficiency.	N/A
Update Settings	Click this button to save any revised settings to the ET-2200 device.	

4.13.2 Publication Settings

Publication Settings

Publication	
Retain	<input type="checkbox"/>
Cycle	9000 (100 ~ 2147483000 ms, in 10 ms step, Default= 9000)
All Information	
Enable	Disable ▾
Sub Topic Name	info (Max. 63 chars)
Last Will and Testament	
Enable	<input type="checkbox"/>
Retain	<input type="checkbox"/>
QoS	0 - At most once ▾
Topic	N/A (Max. 63 chars)
Message	N/A (Max. 63 chars)
Update Settings	

The table describes the parameters contained in the "Publication Settings" section.

Item	Description	Defaults
Publication		
Retain	Check this option to ensure that the message is retained once it is published.	Disabled
Cycle	The time interval that the ET-2200 module periodically publishes data. The valid range is 100 to 2147483000 milliseconds in intervals of 10 milliseconds.	9000(ms)
All Information		
Enable	This option is used to enable or disable the All Information function. All Information adopts Periodic Publish, which includes the Module Name, the MAC address, DI, and DO states. The publishing period depends on the Cycle setting.	Disabled
Sub Topic Name	The Topic Name is a combination of the Main Topic Name and the Sub Topic Name. A shorter Topic Name improves processing efficiency.	info

Item	Description	Defaults
Last Will and Testament		
Enable	Check this option to enable the Last Will and Testament function.	Disabled
Retain	Check this option to ensure that the Last Will and Testament message is retained once it is published.	Disabled
QoS	The QoS for the Last Will and Testament message.	0 - At most once
Topic	The Topic Name for the last will and Testament message. The length should be no more than 63 characters	N/A
Message	The Last Will and Testament message. The length should be no more than 63 characters.	N/A
Update Setting	Click this button to save any revised settings to the ET-2200 device.	

4.13.3 Restore Factory Defaults

Restore Factory Defaults

Restore MQTT factory settings	Restore Defaults
Restart MQTT service	Restart Service

The table describes the parameters contained in the "Restore Factory Defaults" section.

Item	Description
Restore MQTT factory settings	Click this button to reset all MQTT settings to the default factory settings.
Restart MQTT service	Click this button to restart the MQTT service. This function should be used to reconnect with the Broker after adjusting the MQTT settings.

4.14 MQTT-DO

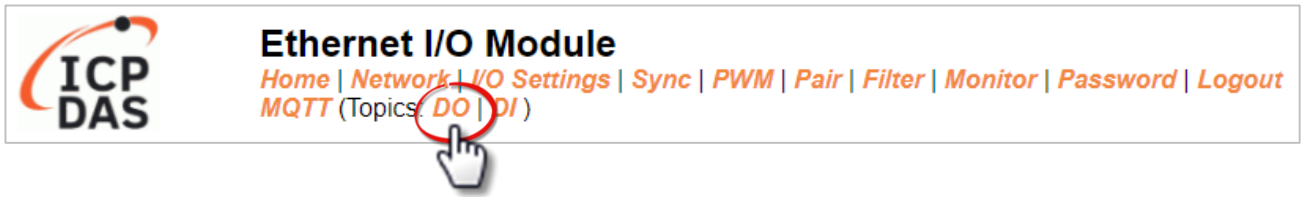

The DO page is where you can set a full Topic Name, which is a combination of the Sub Topic Name and the Main Topic name. The Publish and Subscribe functions for each DO channel can be enabled or disabled on this page. You can use either a single-channel (DO0...) or multiple channels (ALL) to process the Topic operations. Multi-channel operation is recommended because it can help reduce the amount of network traffic.

In single-channel operation, the values 0 and 1 correspond to the OFF and ON settings, respectively. In multi-channel operation, a hexadecimal value represents the settings for all channels. For example, the value 0xFF00 indicates that channels 0 to 7 are OFF and channels 8 to 15 are ON. Please turn off unused Topics to reduce unnecessary processing, as it will affect operational efficiency.

4.14.1 MQTT – Digital Outputs

MQTT - Digital Outputs

Digital Output	Power-on Publish	Subscribe	Sub Topic Name (Max. 63 chars)
ALL	<input type="checkbox"/>	<input type="checkbox"/>	do_all
Digital Output	<input type="checkbox"/> Power-on Publish	<input type="checkbox"/> Subscribe	Sub Topic Name (Max. 63 chars)
DO0	<input type="checkbox"/>	<input type="checkbox"/>	do00
DO1	<input type="checkbox"/>	<input type="checkbox"/>	do01
DO2	<input type="checkbox"/>	<input type="checkbox"/>	do02
DO3	<input type="checkbox"/>	<input type="checkbox"/>	do03
DO4	<input type="checkbox"/>	<input type="checkbox"/>	do04
DO5	<input type="checkbox"/>	<input type="checkbox"/>	do05
DO6	<input type="checkbox"/>	<input type="checkbox"/>	do06
DO7	<input type="checkbox"/>	<input type="checkbox"/>	do07
<input type="button" value="Update"/>			

The table describes the parameters contained in the "MQTT – Digital Outputs" section.

Item	Description	Defaults
Power-on Publish	The DO status will be published when the module is Powered-on. Check the box to enable and uncheck it to disable the function	Disabled
Subscribe	The DO states depend on the updating message of the corresponding Topic. Check the box to enable and uncheck it to disable the function	Disabled
Sub Topic Name	The Topic Name is a combination of the Main Topic Name and the Sub Topic Name. A shorter Topic Name improves processing efficiency.	Corresponding DO
Update	Click this button to save the revised settings to the ET-2200 device.	

4.14.2 Readbacks of the Digital Outputs

Readbacks of the Digital Outputs

Readback	State-Change Publish	Periodic Publish	Sub Topic Name (Max. 63 chars)
ALL	<input type="checkbox"/>	<input type="checkbox"/>	rb_all
Readback	<input type="checkbox"/> State-Change Publish	<input type="checkbox"/> Periodic Publish	Sub Topic Name (Max. 63 chars)
DO0	<input type="checkbox"/>	<input type="checkbox"/>	rb00
DO1	<input type="checkbox"/>	<input type="checkbox"/>	rb01
DO2	<input type="checkbox"/>	<input type="checkbox"/>	rb02
DO3	<input type="checkbox"/>	<input type="checkbox"/>	rb03
DO4	<input type="checkbox"/>	<input type="checkbox"/>	rb04
DO5	<input type="checkbox"/>	<input type="checkbox"/>	rb05
DO6	<input type="checkbox"/>	<input type="checkbox"/>	rb06
DO7	<input type="checkbox"/>	<input type="checkbox"/>	rb07

The table describes the parameters contained in the "Readbacks of the Digital Outputs" section.

Item	Description	Default Value
State-Change Publish	A message will be published when the state of the corresponding DO is changed. Check the box to enable and uncheck it to disable the function	Disabled
Periodic Publish	Used to enable or disable the Periodic Publish function. The publishing period depends on the Cycle settings. Check the box to enable and uncheck it to disable the function	Disabled
Sub Topic Name	The Topic Name is a combination of the Main Topic Name and the Sub Topic Name. A shorter Topic Name improves processing efficiency.	Corresponding DO
Update	Click this button to save the revised settings to the ET-2200 device.	

4.15 MQTT-DI

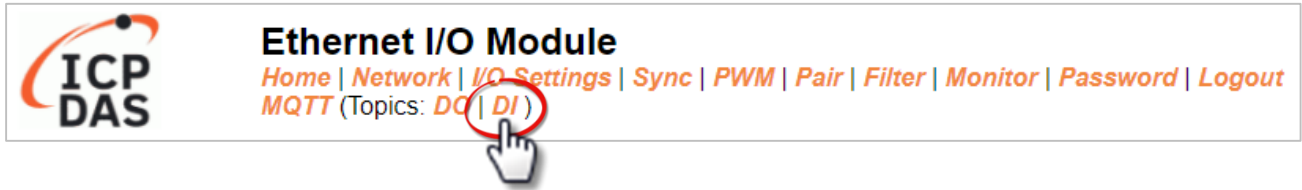

The DI page is where you can set the Topic Name, which is a combination of the Sub Topic Name and the Main Topic name. The Publish function for each DI channel can also be either enabled or disabled on this page. You can use either a single-channel (DI0...) or multiple-channels (ALL) to process the Topic operations. Multi-channel operation is recommended because it can help reduce the amount of network traffic.

In single-channel operation, the values 0 and 1 correspond to the OFF and ON settings, respectively. In multi-channel operation, a hexadecimal value represents the settings for all channels. For example, the value 0xFF00 indicates that channels 0 to 7 are OFF, and channels 8 to 15 are ON. Please turn off (uncheck the checkbox) unused Topics to reduce unnecessary processing, as it will affect operational efficiency.

4.15.1 MQTT – Digital Inputs

MQTT - Digital Inputs

Digital Input	State-Change Publish	Periodic Publish	Sub Topic Name (Max. 63 chars)
ALL	<input type="checkbox"/>	<input type="checkbox"/>	di_all
Digital Input	<input type="checkbox"/> State-Change Publish	<input type="checkbox"/> Periodic Publish	Sub Topic Name (Max. 63 chars)
D10	<input type="checkbox"/>	<input type="checkbox"/>	di00
D11	<input type="checkbox"/>	<input type="checkbox"/>	di01
D12	<input type="checkbox"/>	<input type="checkbox"/>	di02
D13	<input type="checkbox"/>	<input type="checkbox"/>	di03
D14	<input type="checkbox"/>	<input type="checkbox"/>	di04
D15	<input type="checkbox"/>	<input type="checkbox"/>	di05
D16	<input type="checkbox"/>	<input type="checkbox"/>	N/A
D17	<input type="checkbox"/>	<input type="checkbox"/>	N/A
<input type="button" value="Update"/>			

The table describes the parameters contained in the "MQTT – Digital Inputs" section.

Item	Description	Default Value
State-Change Publish	A message will be published when the state of the corresponding DI is changed. Check the box to enable and uncheck it to disable the function	Disabled
Periodic Publish	to enable or disable the Periodic Publish function. The publishing period depends on the Cycle settings. Check the box to enable and uncheck it to disable the function	Disabled
Sub Topic Name	The Topic Name is a combination of the Main Topic Name and the Sub Topic Name. A shorter Topic Name improves processing efficiency.	Corresponding DI
Update	Click this button to save the revised settings to the ET-2200 device.	

4.16 MQTT-AI

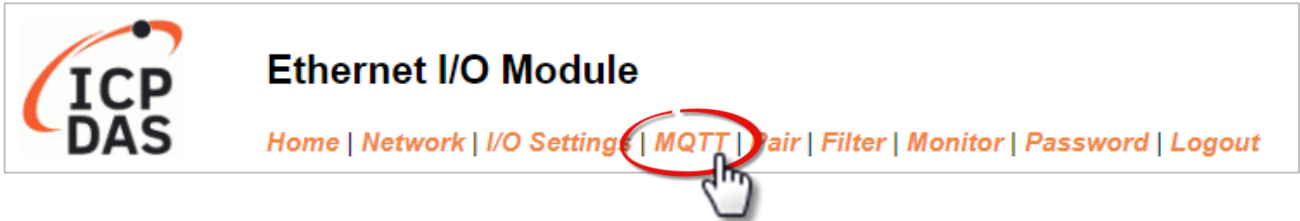

Analog Inputs

Analog Input	<input type="checkbox"/> Periodic Publish	Sub Topic Name (Max. 63 chars)
AI0	<input checked="" type="checkbox"/>	ai00
AI1	<input checked="" type="checkbox"/>	ai01
AI2	<input checked="" type="checkbox"/>	ai02
AI3	<input checked="" type="checkbox"/>	ai03
AI4	<input checked="" type="checkbox"/>	ai04
AI5	<input checked="" type="checkbox"/>	ai05
AI6	<input checked="" type="checkbox"/>	ai06
AI7	<input checked="" type="checkbox"/>	ai07
<input type="button" value="Update"/>		

The table describes the parameters contained in the "MQTT – Analog Inputs" section.

Item	Description	Defaults
Periodic Publish	to enable or disable the Periodic Publish function. The publishing period depends on the Cycle settings. Check the box to enable and uncheck it to disable the function	Disabled
Sub Topic Name	The Topic Name is a combination of the Main Topic Name and the Sub Topic Name. A shorter Topic Name improves processing efficiency.	Corresponding AI
Update	Click this button to save the revised settings to the ET-2200 device.	

4.17 MQTT- Realization

This section described how to use the open-source software Mosquitto and MQTTLens to demonstrate the usage of MQTT protocol in conjunction with the ET-2200 series module.

4.17.1 Set up Mosquitto

Mosquitto is an open-source software application that allows you to create an MQTT Broker and can be installed on Windows, Mac OS, Linux, etc.

Step 1 Download the Installer (v1.6.4) from the official Mosquitto [website](#) and install the application.

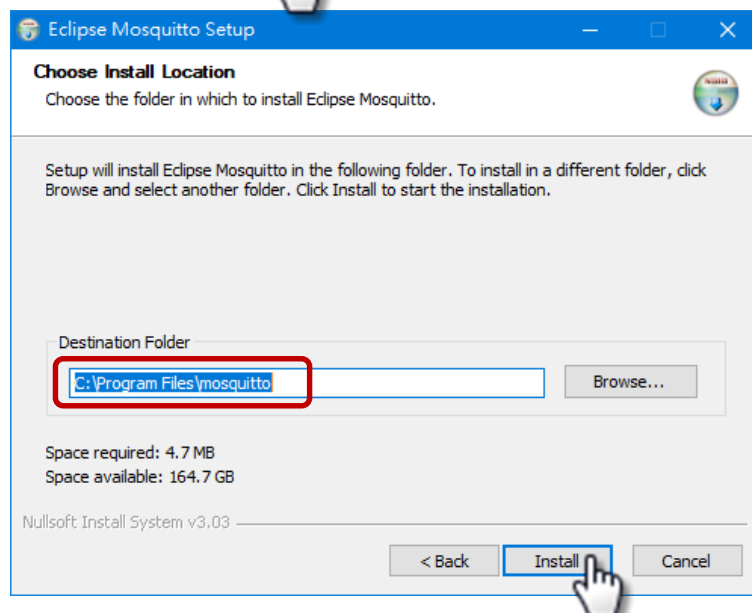
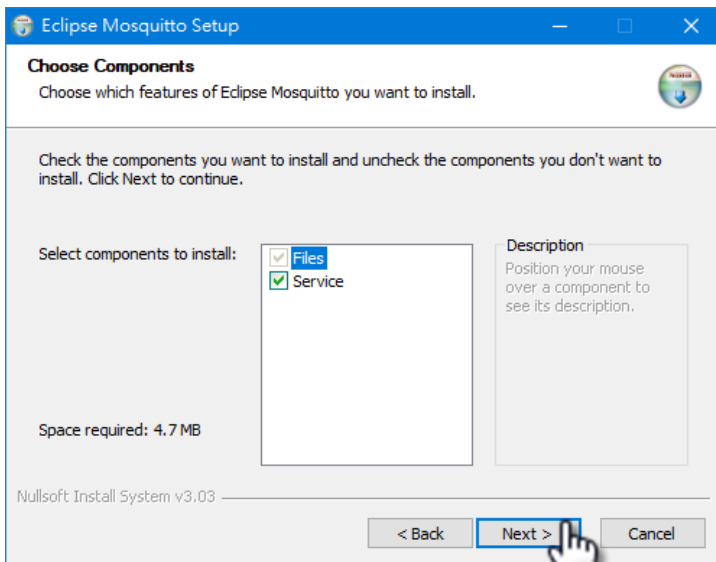

Step 2 Locate the “mosquitto.exe” file in the default installation path and double-click it to enable the Mosquitto server.

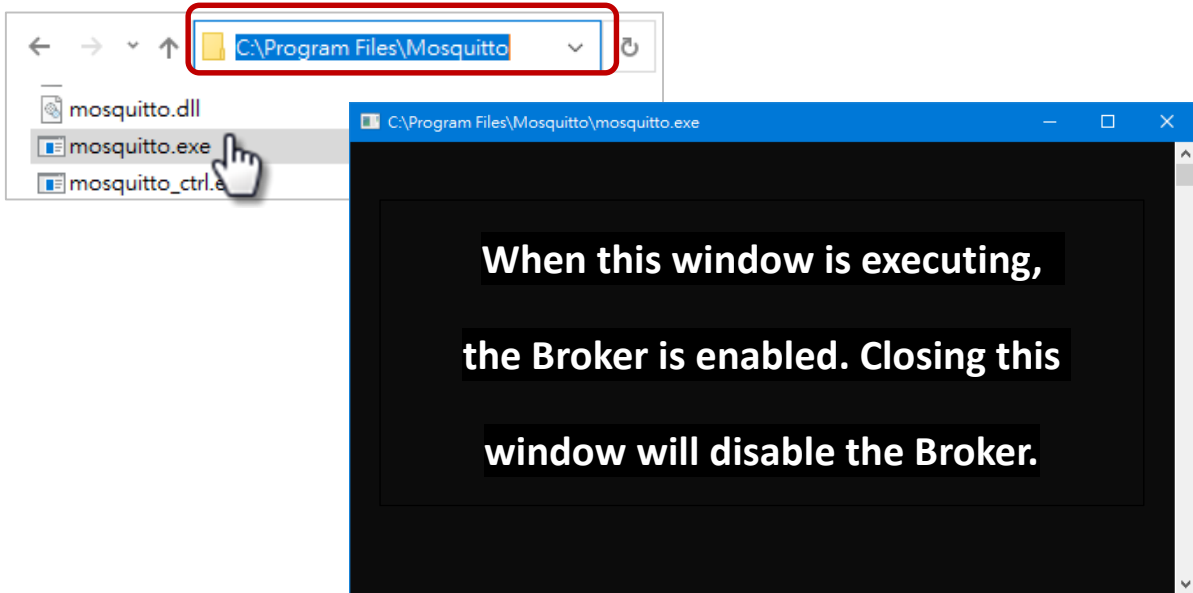

⚠ Why can't I open “mosquitto.exe” or why does it crash?

Once the Mosquitto installation is complete, **the Broker server will be automatically enabled by default when the computer boots**. Therefore, the Broker is already enabled after the computer reboots. At this time, clicking the “mosquitto.exe” file again will be the same as attempting to enable an already enabled-Broker server, and the attempt will be blocked.

To prevent the broker from automatically opening, you can change the settings in the Windows Services application. If it is not necessary to set it, go to Step 3.

Open the Services application by searching for “Services”.

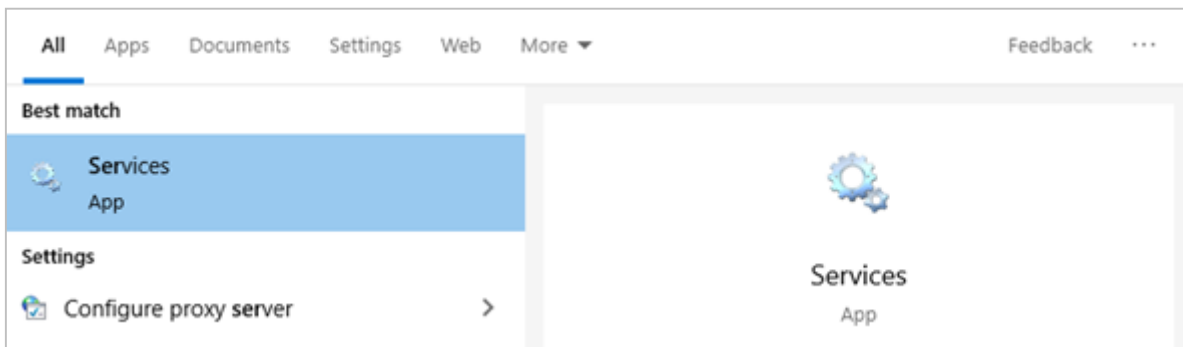

In the Services application, locate the "Mosquitto Broker" item and double-click the name to open the **Properties** dialog. Click the **Stop** button and set the **Startup type** to **Manual**. Click **OK** to save your changes.

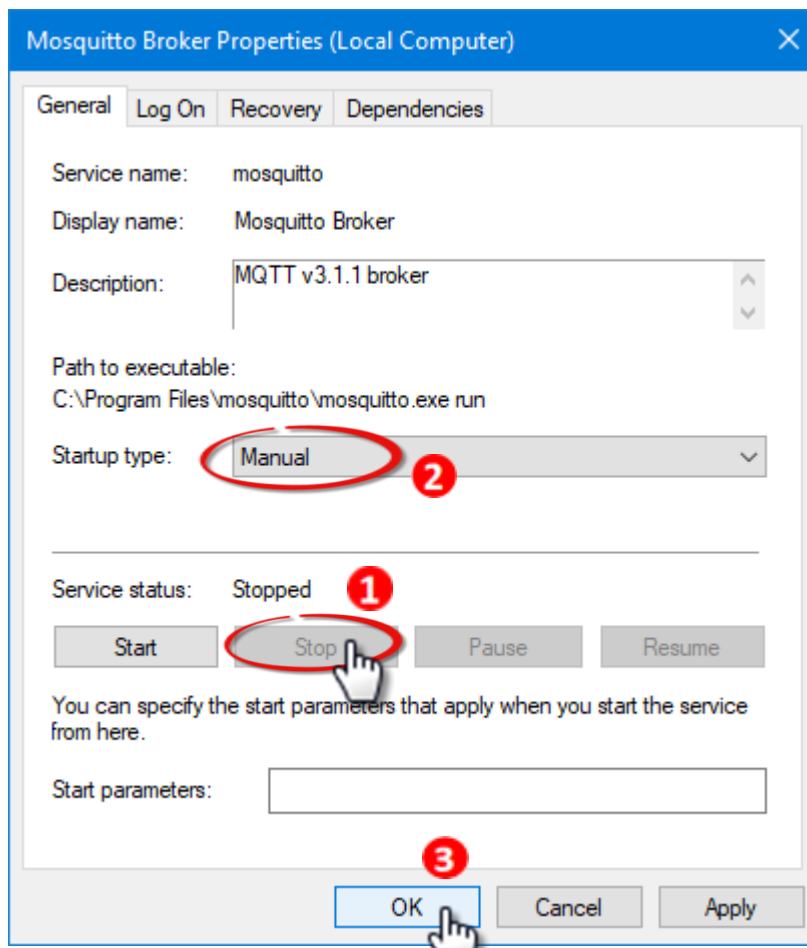
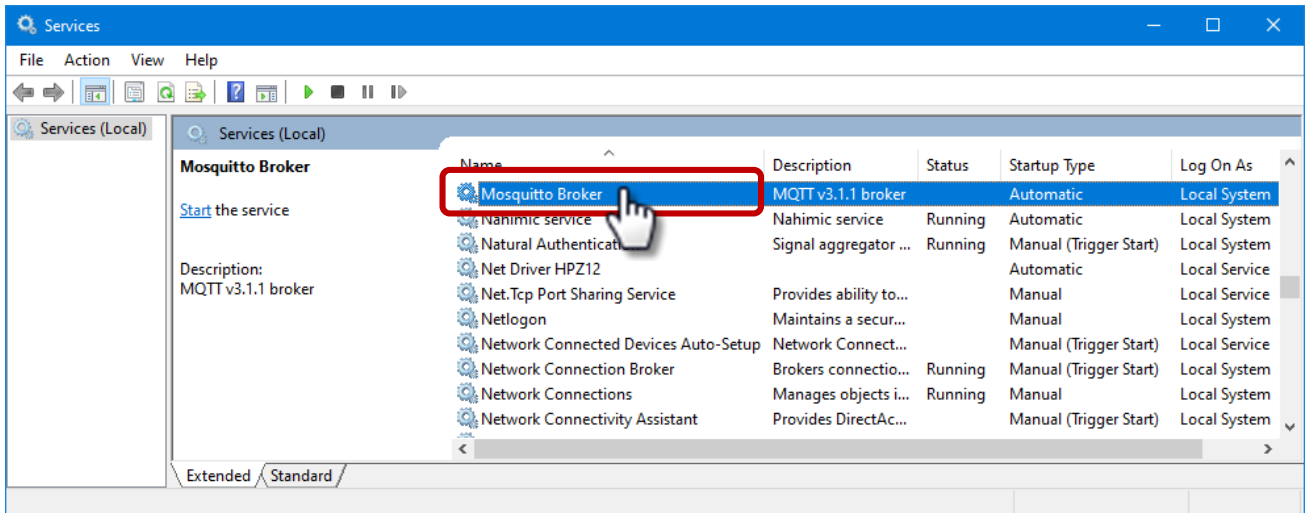

Step 3 Open Windows Port 1883 (the default Port for the MQTT)

3.1 Open the **Advanced Settings** section for the Windows Firewall.

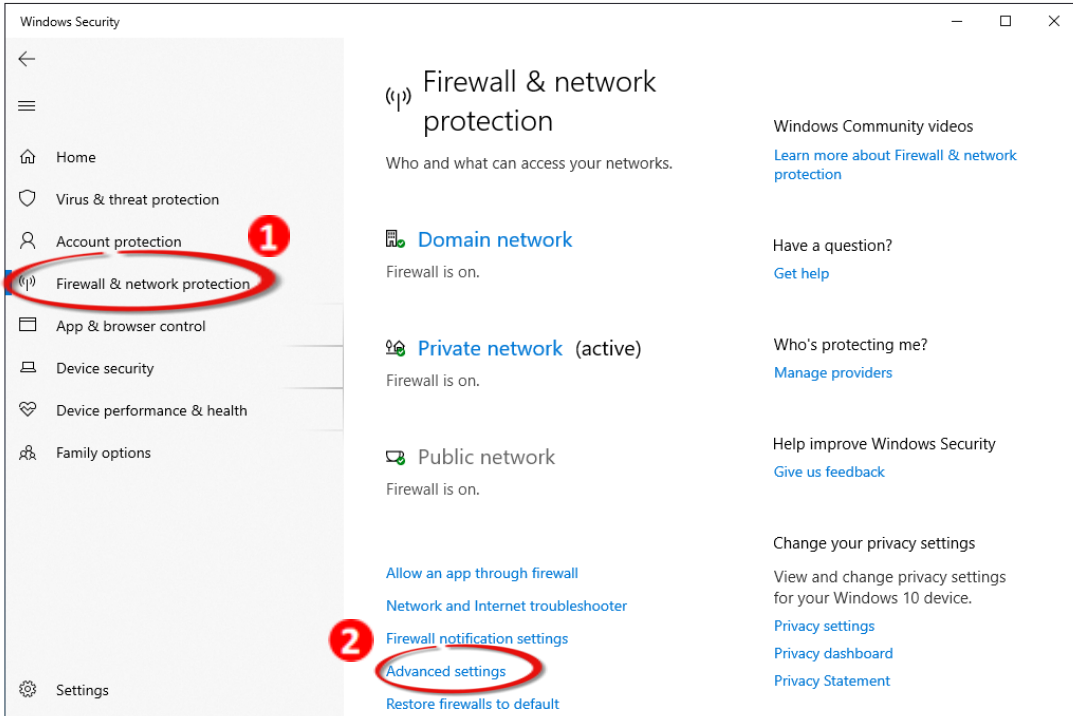

3.2 Add a new rule. Click **Inbound Rules** and **New Rule**, and then select the **Port** option. Click the **Next** button to continue.

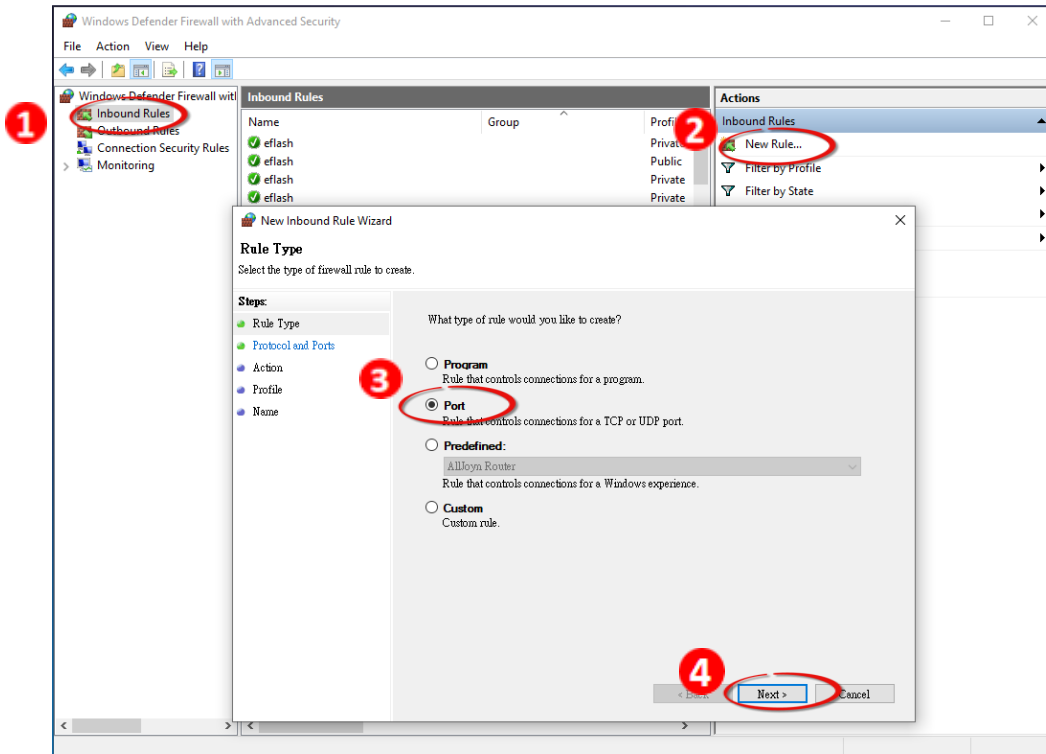

- 3.3 Select the **TCP** option and then select **Specific local ports** and enter the value **1883**. Click the **Next** button to continue.

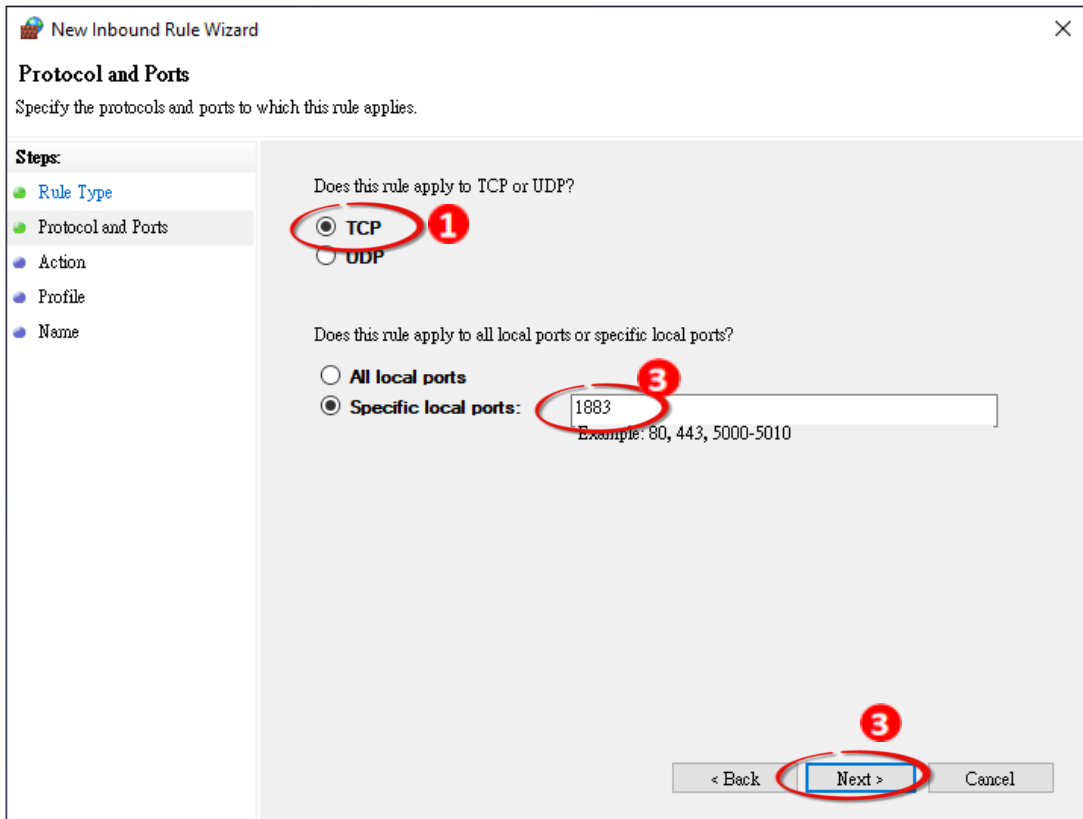

- 3.4 Select the **Allow the connection** option and then click the **Next** button to continue.

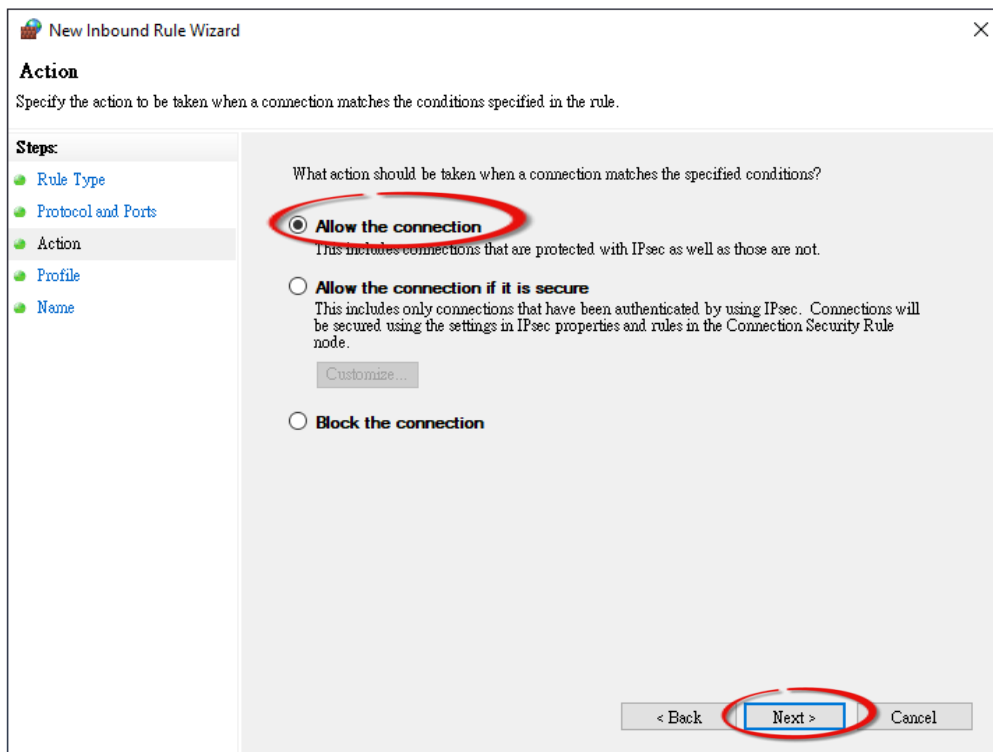

3.5 Select the **Domain** checkbox and click the **Next** button to continue.

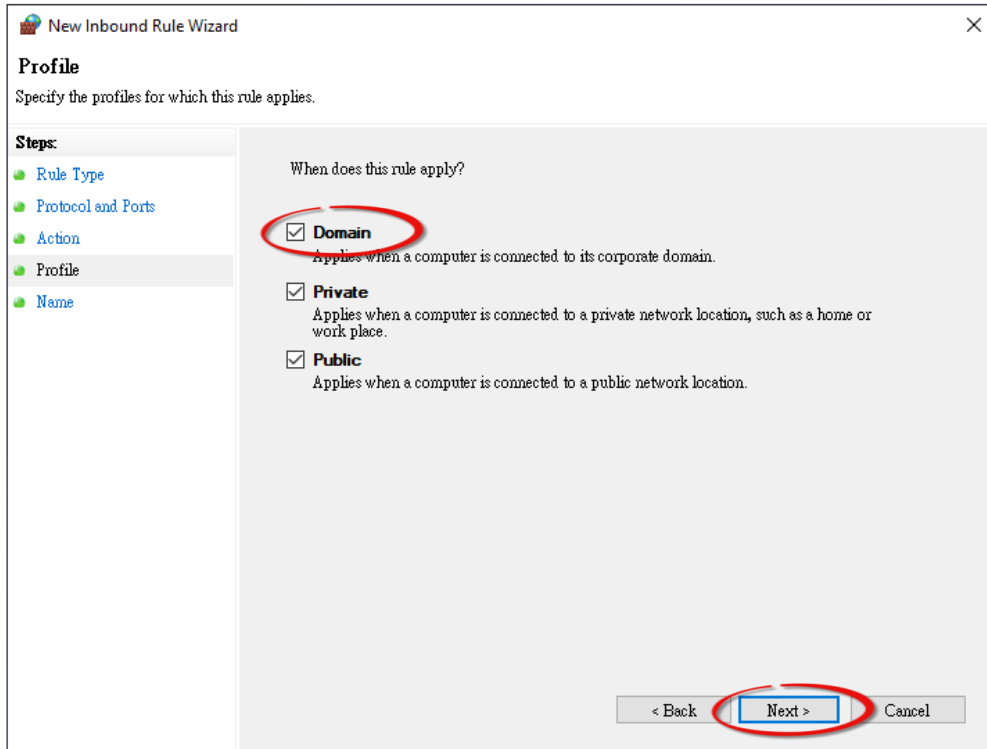

3.6 Enter the name of the rule and then click the **Finish** button to create the rule. Enter the notes if desired.

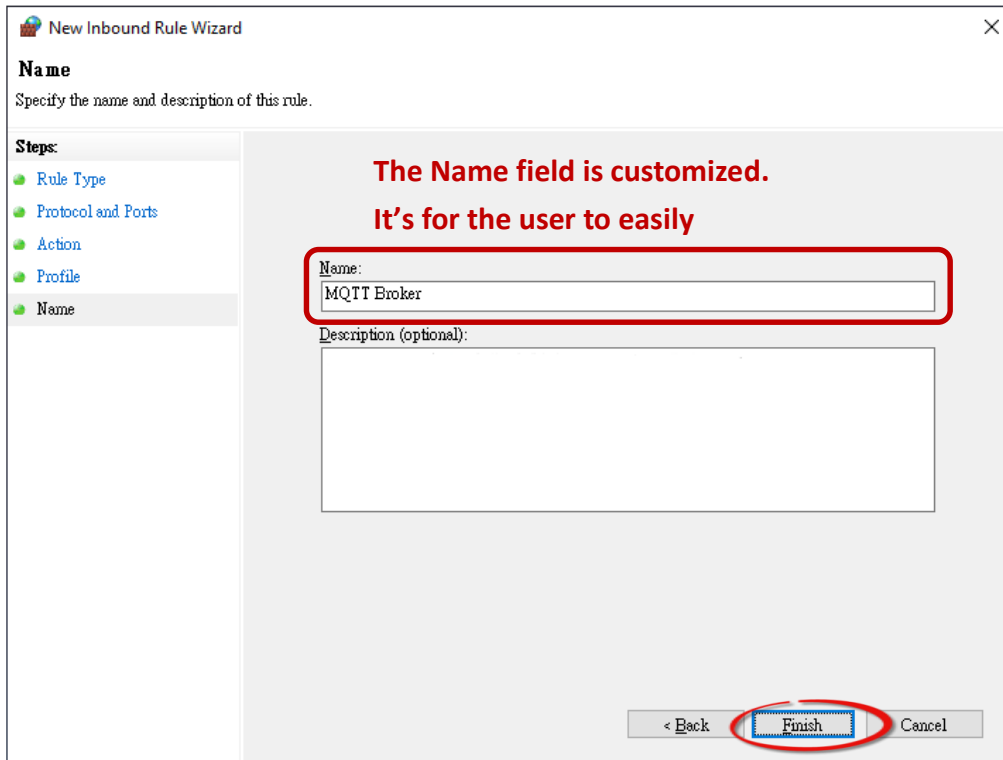

4.17.2 Introduction to MQTTLens

MQTTLens is a free application that is available for the Chrome browser and can be found in the Chrome Web Store. This program enables you to publish a topic to the Broker and subscribe to a topic from the Broker. This section will use MQTTLens to implement the basic architecture for MQTT on Windows.

Step 1 Install MQTTLens

Open Chrome and search for the 'MQTTLens chrome web store'. Click the 'Add to Chrome' button to install it on your system.

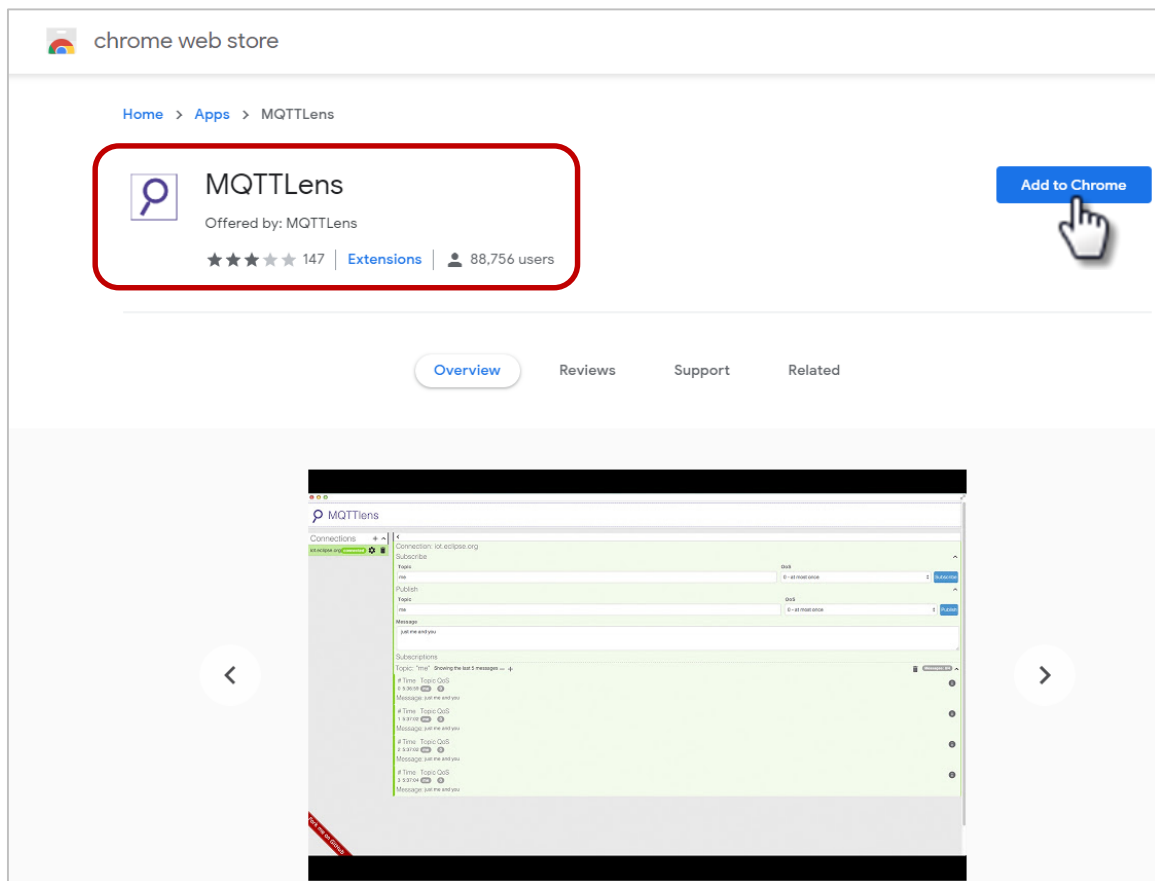

Step 2 Connect the Broker

Execute MQTTLens on Chrome. Click the "+" button to add a connection and enter the IP address for the Broker, i.e., the IP address for the computer where the MQTT server is located. Click the **Create Connection** button to continue.

 **What is a Broker?**

A Broker is a Server in the MQTT architecture. Refer to Section [4.12 MQTT](#) for more details.

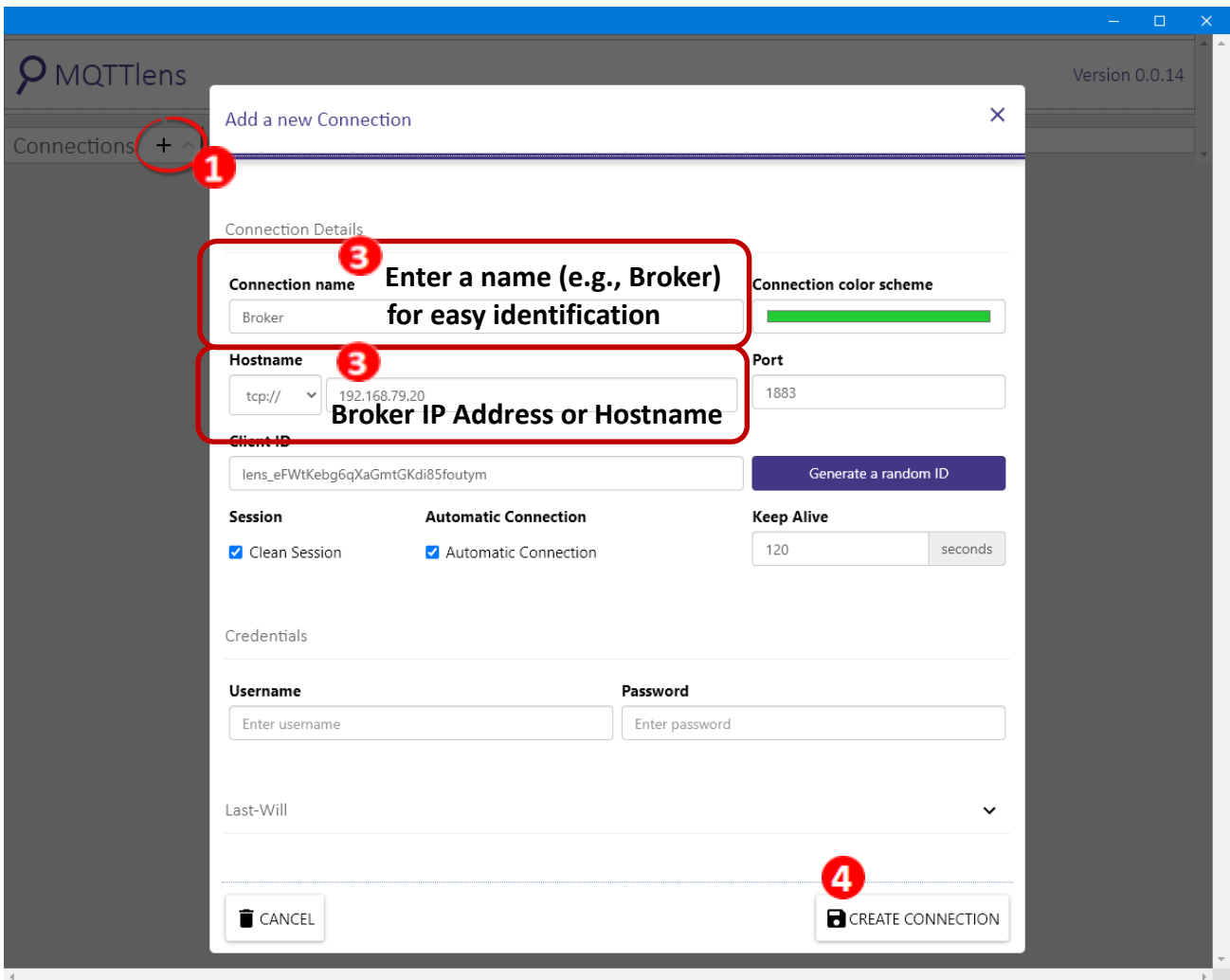

Step 3 Try to subscribe to a topic and publish a message. If the connection is operating normally, you will receive a message related to the defined topic, as follows.

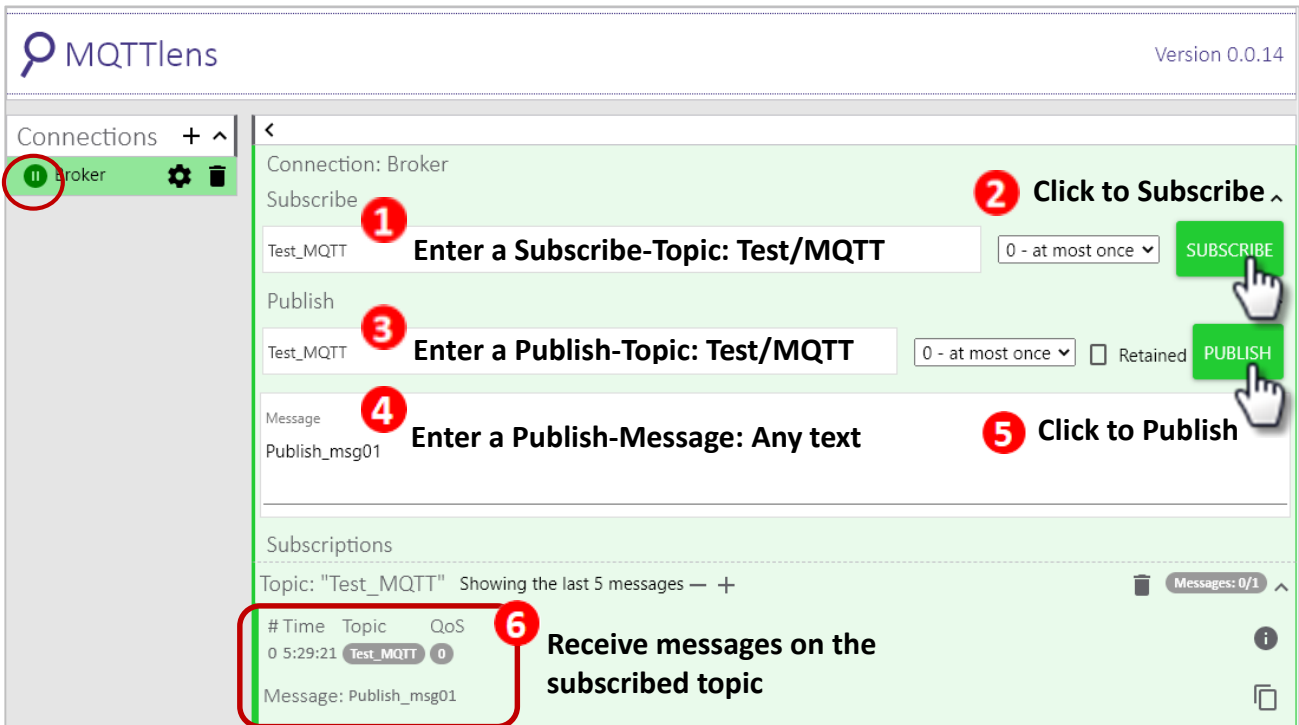

4.17.3 ET-2200 Periodic Publish Realization

Step 1 Refer [Set up Mosquitto](#) to install a Broker and refer to the [Introduction to MQTTLens](#) to subscribe to the "ICPDAS/info" Topic.



Step 2 Log into the ET-2200 Web Server and click the [MQTT](#) page. Set the MQTT option to Enable and enter the IP address for the Broker.

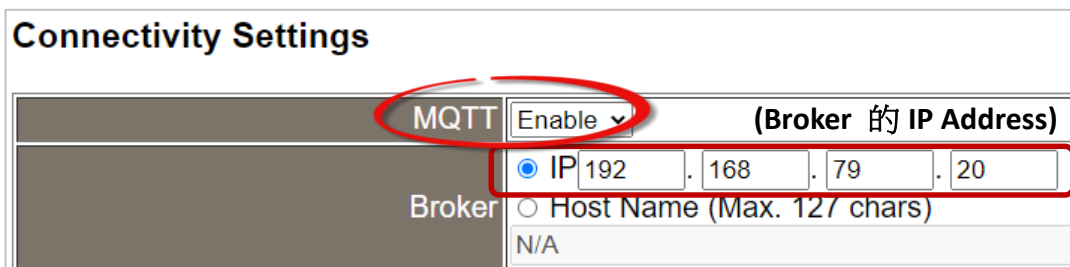

Step 3 Enter "ICPDAS/" in the Main Topic Name field and then click the **Update Settings** button.

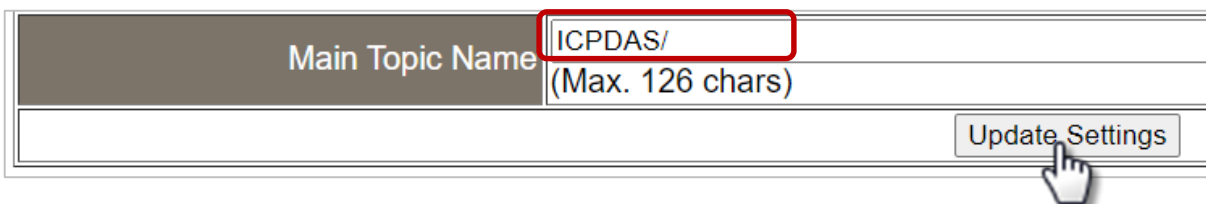

Step 4 Set the Enable field in the All Information section to **Enable** on the Publication Settings page, and then click the **Update Settings** button. Click the **Restart Service** button to restart the MQTT services.

Publication Settings

Publication	
Retain	<input type="checkbox"/>
Cycle	9000 (100 ~ 2147483000 ms, in 10 ms step, Default= 9000)
All Information	
Enable	Enable 2
Sub Topic Name	info (Max. 63 chars)
Last Will and Testament	
Enable	<input type="checkbox"/>
Retain	<input type="checkbox"/>
QoS	0 - At most once
Topic	N/A (Max. 63 chars)
Message	N/A (Max. 63 chars)
Update Settings 2	

Restore Factory Defaults

Restore MQTT factory settings	3 Restore Defaults
Restart MQTT service	Restart Service

Step 5 Return to MQTTLens, the updated message for the subscription, including Module name, Mac Address, DO State, and DI State, has been received every 9000 ms (default cycle).

Subscriptions

Topic: "ICPDAS/info" Showing the last 5 messages — + Messages: 0/5 ^

#	Time	Topic	QoS	
0	6:02:16	ICPDAS/info		{"Module Name": "ET-2260", "MacAddress": "000DE065CFD3", "DO": "0x0", "DI": "0x0"}
				JSON 📄
1	6:02:25	ICPDAS/info		{"Module Name": "ET-2260", "MacAddress": "000DE065CFD3", "DO": "0x0", "DI": "0x0"}
				JSON 📄
2	6:02:34	ICPDAS/info		{"Module Name": "ET-2260", "MacAddress": "000DE065CFD3", "DO": "0x0", "DI": "0x0"}
				JSON 📄

! What if no messages are received by MQTTLens?

Confirm that the settings for the Windows firewall and antivirus software are correct. Close the software to test if they are affecting your connection.

4.18 SNMP

The "SNMP" page provides the function for ET-2200 to send module information and I/O information to the SNMP Network Management Software or device to help administrators to monitor the status of the ET-2200 in real time.

If the Trap function is enabled, ET-2200 can actively send messages to the SNMP manager to keep track of data when the I/O status of the module changes or restarts. The detailed description is as follows.

Note:

For DI/DO modules:

SNMP function is available for **Firmware v2.3.4** and later. It is not supported for older versions.

For AI/AO modules:

SNMP function is available for **Firmware v1.60** and later. It is not supported for older versions.

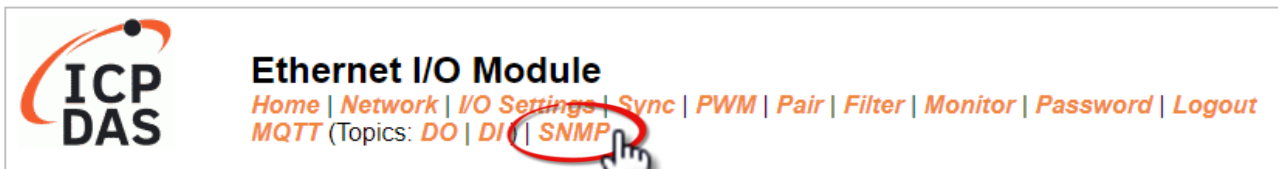

Note:

ET-2200 currently supports these MIB-II management groups such as sysContact, sysLocation, sysDescr, and sysName.

4.18.1 SNMP Configuration Setting

SNMP v2c Agent Configuration

System Info		Setting
Contact	User	(Max. 47 chars)
Location	Site	(Max. 47 chars)
Description	EtherIO	(Max. 47 chars)
Name	Device	(Max. 47 chars)
Function		Setting
Read-Only Community	public	(Max. 47 chars, example: public)
Read-Write Community	private	(Max. 47 chars, example: private)
Trap Community	public	(Max. 47 chars, example: public)
Manager / Trap IP #1	0.0.0.0	(IPv4/v6 Address, example: 10.0.8.123, fe80:0:0:0:a8ee:dc07:1cda:5678)
Manager / Trap IP #2	0.0.0.0	
Generic Trap	<input type="checkbox"/> Cold Start, <input type="checkbox"/> Warm Start	
Enable SNMP	<input type="checkbox"/> Check to enable. (Default disabled)	
<input type="button" value="Update Settings"/>		

The table describes the parameters contained in the "System Info " section.

Item	Description	Default Value
Contact	The SNMP server's contact person	User
Location	The server's location	Site
Description	The description of the device displayed on the Server	EtherIO
Name	The name of the device displayed on the Server	Device

The table describes the parameters contained in the "Function" section.

Item	Description	Default Value
Read-Only Community	Set the community name of the module for read-only data	public
Read-Write Community	Set the community name of the module for read-write data	private
Trap Community	Set the community name of the module for the trap	public
Manager / Trap IP #1	Set the IP address of Trap IP #1	0.0.0.0
Manager / Trap IP #2	Set the IP address of Trap IP #2	0.0.0.0
Generic Trap	Select to enable the Cold Start or Warm Start function	Disabled
Enable SNMP	Select the box to enable the SNMP communication function and deselect to disable it	Disabled
Update Settings	After saving the settings, also reboot the module to take effect	

4.18.2 SNMP Specific Trap

SNMP Specific Trap																	
Digital Input	State-Change / Specific ID (1-255)																
All <input type="checkbox"/> 1	A single trap contains all DI states when any DI changes.																
<input type="checkbox"/> DI 7 - 0	<table border="1"> <tr> <td>DI7:</td> <td>DI6:</td> <td>DI5: <input type="checkbox"/></td> <td>DI4: <input type="checkbox"/></td> <td>DI3: <input type="checkbox"/></td> <td>DI2: <input type="checkbox"/></td> <td>DI1: <input type="checkbox"/></td> <td>DI0: <input type="checkbox"/></td> </tr> <tr> <td></td> <td></td> <td>1</td> <td>1</td> <td>1</td> <td>1</td> <td>1</td> <td>1</td> </tr> </table>	DI7:	DI6:	DI5: <input type="checkbox"/>	DI4: <input type="checkbox"/>	DI3: <input type="checkbox"/>	DI2: <input type="checkbox"/>	DI1: <input type="checkbox"/>	DI0: <input type="checkbox"/>			1	1	1	1	1	1
DI7:	DI6:	DI5: <input type="checkbox"/>	DI4: <input type="checkbox"/>	DI3: <input type="checkbox"/>	DI2: <input type="checkbox"/>	DI1: <input type="checkbox"/>	DI0: <input type="checkbox"/>										
		1	1	1	1	1	1										
Digital Output	State-Change / Specific ID (1-255)																
All <input type="checkbox"/> 1	A single trap contains all DO states when any DO changes.																
<input type="checkbox"/> DO 7 - 0	<table border="1"> <tr> <td>DO7:</td> <td>DO6:</td> <td>DO5: <input type="checkbox"/></td> <td>DO4: <input type="checkbox"/></td> <td>DO3: <input type="checkbox"/></td> <td>DO2: <input type="checkbox"/></td> <td>DO1: <input type="checkbox"/></td> <td>DO0: <input type="checkbox"/></td> </tr> <tr> <td></td> <td></td> <td>1</td> <td>1</td> <td>1</td> <td>1</td> <td>1</td> <td>1</td> </tr> </table>	DO7:	DO6:	DO5: <input type="checkbox"/>	DO4: <input type="checkbox"/>	DO3: <input type="checkbox"/>	DO2: <input type="checkbox"/>	DO1: <input type="checkbox"/>	DO0: <input type="checkbox"/>			1	1	1	1	1	1
DO7:	DO6:	DO5: <input type="checkbox"/>	DO4: <input type="checkbox"/>	DO3: <input type="checkbox"/>	DO2: <input type="checkbox"/>	DO1: <input type="checkbox"/>	DO0: <input type="checkbox"/>										
		1	1	1	1	1	1										
<input type="button" value="Update Settings"/>																	
<input type="button" value="Reboot"/> is required after SNMP configuration.																	

The table describes the parameters contained in the " **Digital Input/ Digital Output** " section.

Item	Description
Digital Input	
All	All DI channels share a single Trap. Check the box to send a Trap message when any DI status changes. "Specific ID" is the ID number set for this Trap
DI 7-0	Each DI channel has a specific Trap. Check the box to enable the Trap function for that DI channel. "Specific ID" is the ID number set for individual channel
Digital Output	
All	All DO channels share a single Trap. Check the box to send a Trap message when any DO status changes. "Specific ID" is the ID number set for this Trap.
DO 7-0	Each DO channel has a specific Trap. Check the box to enable the Trap function for that DO channel. "Specific ID" is the ID number set for individual channel
Update Setting	After changing and saving the settings, also reboot the module to take effect
Reboot	Click the button to reboot the module

SNMP Specific Trap

Analog Output	State-Change	Specific ID (1-255)
A00	<input type="checkbox"/>	1
A01	<input type="checkbox"/>	1
A02	<input type="checkbox"/>	1
A03	<input type="checkbox"/>	1
A04	<input type="checkbox"/>	1
A05	<input type="checkbox"/>	1
A06	<input type="checkbox"/>	1
A07	<input type="checkbox"/>	1
<input type="button" value="Update Settings"/>		

The table describes the parameters contained in the " **Analog Output** " section.

Item	Description
Analog Output	
AO 7-0	Each AO channel has a specific Trap. Check the box to enable the Trap function for that AO channel. "Specific ID" is the ID number set for individual channel
Update Setting	After changing and saving the settings, also reboot the module to take effect
Reboot	Click the button to reboot the module

4.18.3 SNMP I/O Example

In this article, we use **iReasoning MIB Browser** as an example. Please download the installer (V14) from its official website and run the installer.

<http://www.ireasoning.com/mibbrowser.shtml>

Step 1 Start the **iReasoning MIB Browser**. Click the **File** → **Load MIBs** on the menu bar and click the specified MIB file of the module (e.g. ICPDAS-ET2200-MIB_20220705.mib), then click the Open button to open it.

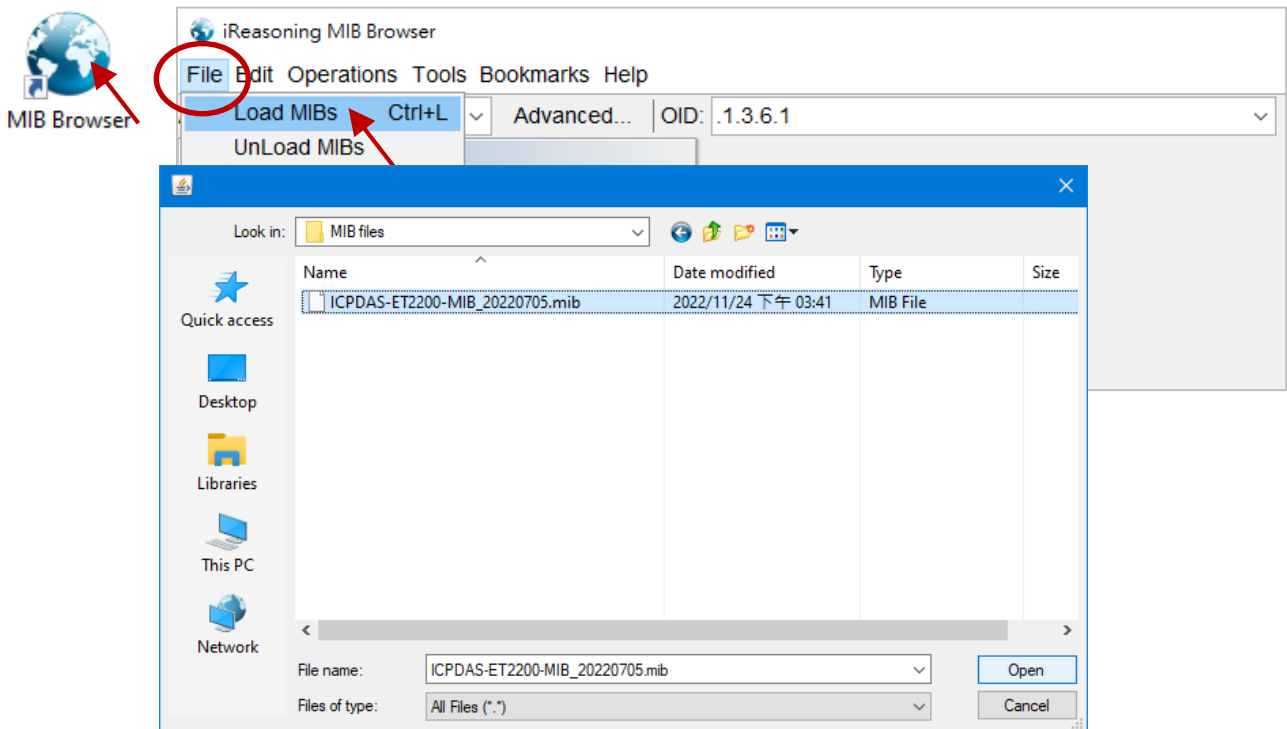

Step 2 Enter the IP address of the ET-2200 module in the **Address** field.

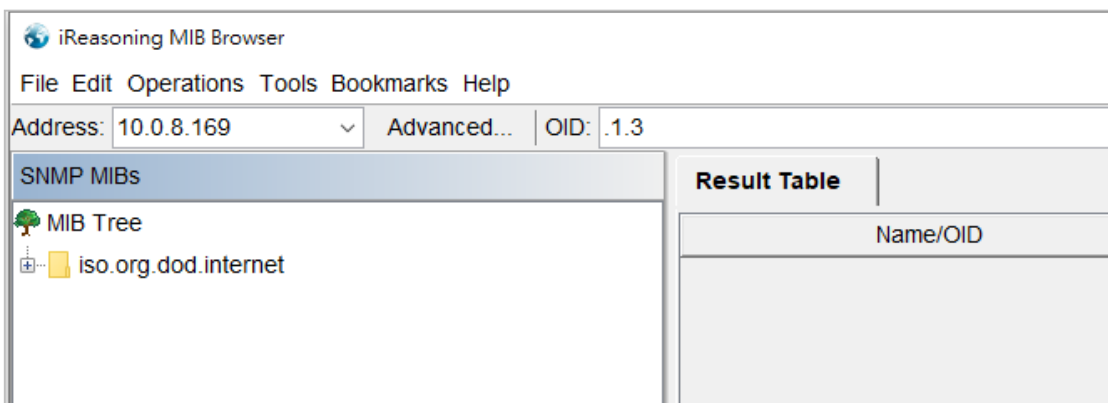

Step 3 Click “Advanced...” to set the parameters of the SNMP agent. Enter the string in the **Read/Write Community** fields according to the **Read-Only Community / Read-Write Community** settings on the ET-2200. If these strings are different on both sides, the agent will not work correctly.

Function	Setting
Read-Only Community	public (Max. 47 chars, example: public)
Read-Write Community	private (Max. 47 chars, example: private)

Enter the string according to the settings on ET-2200.

Note: If the **Write Community** field is not set, a Timeout error will occur during execution.

Step 4 Enter the IP address of **iReasoning MIB Browser** in the **Manager/Trap IP #1** field and enable the SNMP function, then click **Update Settings** to save the changes, and finally click the **Reboot** button to reboot the ET-2200 module.

Function	Setting
Read-Only Community	public (Max. 47 chars, example: public)
Read-Write Community	private (Max. 47 chars, example: private)
Trap Community	public (Max. 47 chars, example: public)
Manager / Trap IP #1	10.0.8.17 (IPv4/v6 Address, example: 10.0.8.123, fe80:0:0:a8ee:dc07:1cda:5678)
Manager / Trap IP #2	0.0.0.0
Generic Trap	<input type="checkbox"/> Cold Start, <input type="checkbox"/> Warm Start
Enable SNMP	<input checked="" type="checkbox"/> Check to enable. (Default disabled)

Update Settings

Reboot is required after SNMP configuration.

Read the information of the ET-2200 – the Walk command

To do: Right-click the **iso.org.dod.internet** folder on the left side and click **Walk** to display the information of the ET-2200 in the **Result Table**.

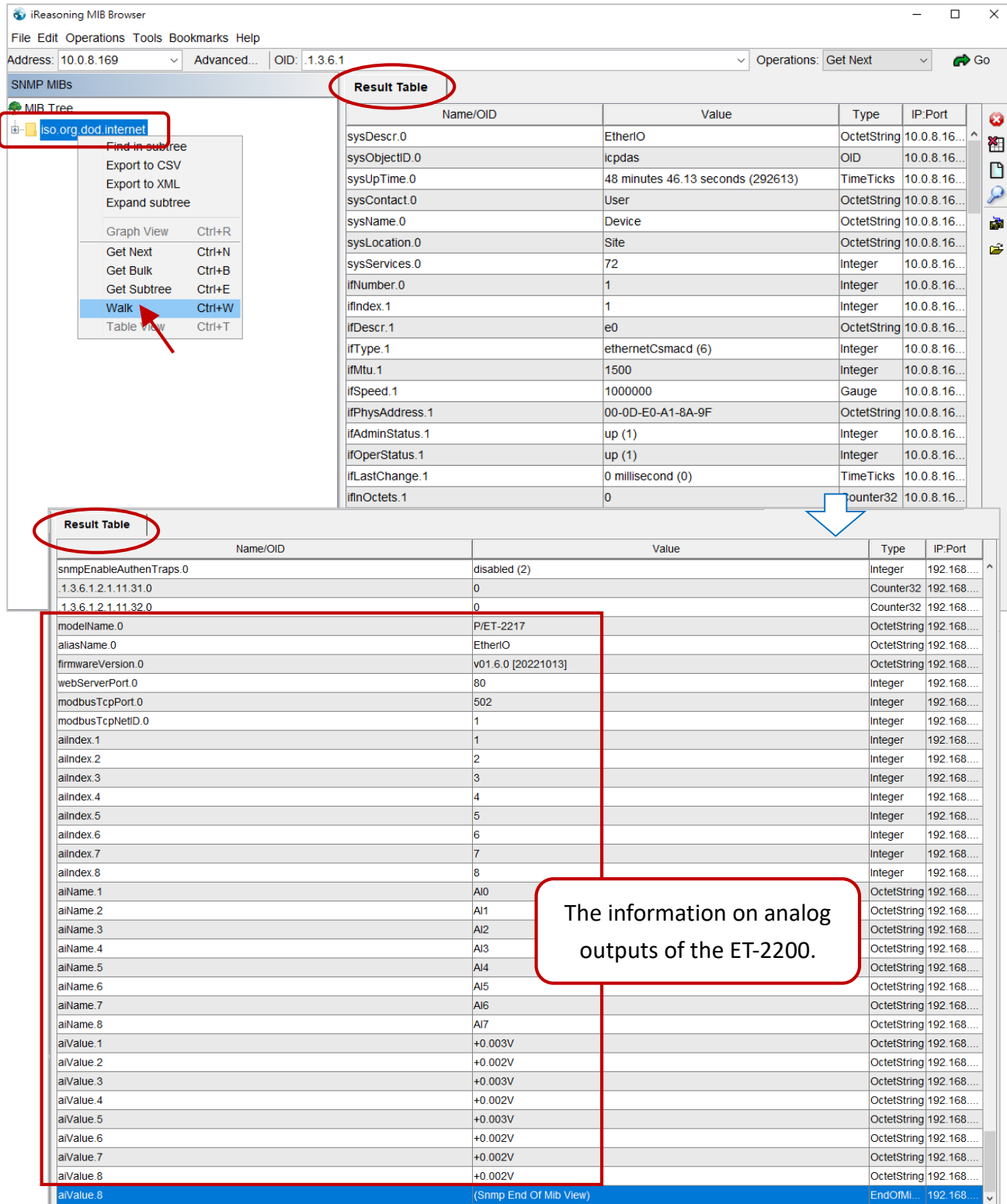

The screenshot shows the iReasoning MIB Browser interface. On the left, the MIB Tree is expanded to 'iso.org.dod.internet'. A context menu is open over this folder, with the 'Walk' option selected. The main window displays a 'Result Table' with the following data:

Name/OID	Value	Type	IP:Port
sysDescr.0	EtherIO	OctetString	10.0.8.16...
sysObjectID.0	icpdas	OID	10.0.8.16...
sysUpTime.0	48 minutes 46.13 seconds (292613)	TimeTicks	10.0.8.16...
sysContact.0	User	OctetString	10.0.8.16...
sysName.0	Device	OctetString	10.0.8.16...
sysLocation.0	Site	OctetString	10.0.8.16...
sysServices.0	72	Integer	10.0.8.16...
ifNumber.0	1	Integer	10.0.8.16...
ifIndex.1	1	Integer	10.0.8.16...
ifDescr.1	e0	OctetString	10.0.8.16...
ifType.1	ethernetCsmacd (6)	Integer	10.0.8.16...
ifMtu.1	1500	Integer	10.0.8.16...
ifSpeed.1	1000000	Gauge	10.0.8.16...
ifPhysAddress.1	00-0D-E0-A1-8A-9F	OctetString	10.0.8.16...
ifAdminStatus.1	up (1)	Integer	10.0.8.16...
ifOperStatus.1	up (1)	Integer	10.0.8.16...
ifLastChange.1	0 millisecond (0)	TimeTicks	10.0.8.16...
ifInOctets.1	0	Counter32	10.0.8.16...

The 'Result Table' is also shown in a zoomed-in view below, highlighting the analog output information:

Name/OID	Value	Type	IP:Port
snmpEnableAuthenTraps.0	disabled (2)	Integer	192.168...
.1.3.6.1.2.1.11.31.0	0	Counter32	192.168...
.1.3.6.1.2.1.11.32.0	0	Counter32	192.168...
modelName.0	P/ET-2217	OctetString	192.168...
aliasName.0	EtherIO	OctetString	192.168...
firmwareVersion.0	v01.6.0 [20221013]	OctetString	192.168...
webServerPort.0	80	Integer	192.168...
modbusTcpPort.0	502	Integer	192.168...
modbusTcpNetID.0	1	Integer	192.168...
aiIndex.1	1	Integer	192.168...
aiIndex.2	2	Integer	192.168...
aiIndex.3	3	Integer	192.168...
aiIndex.4	4	Integer	192.168...
aiIndex.5	5	Integer	192.168...
aiIndex.6	6	Integer	192.168...
aiIndex.7	7	Integer	192.168...
aiIndex.8	8	Integer	192.168...
aiName.1	AI0	OctetString	192.168...
aiName.2	AI1	OctetString	192.168...
aiName.3	AI2	OctetString	192.168...
aiName.4	AI3	OctetString	192.168...
aiName.5	AI4	OctetString	192.168...
aiName.6	AI5	OctetString	192.168...
aiName.7	AI6	OctetString	192.168...
aiName.8	AI7	OctetString	192.168...
aiValue.1	+0.003V	OctetString	192.168...
aiValue.2	+0.002V	OctetString	192.168...
aiValue.3	+0.003V	OctetString	192.168...
aiValue.4	+0.002V	OctetString	192.168...
aiValue.5	+0.003V	OctetString	192.168...
aiValue.6	+0.002V	OctetString	192.168...
aiValue.7	+0.002V	OctetString	192.168...
aiValue.8	+0.002V	OctetString	192.168...

The information on analog outputs of the ET-2200.

Control the DO channel to ON/OFF – the SET command

To do: Right-click the **doValue** entry in the **Result Table** and click **Set** to display the **SNMP SET** dialog box. Enter the value 0 (OFF) or 1 (ON) in the **Value** field to set the DO value.

Result Table

Name/OID	Value	Type	IP:Port
doName.1	DO0	OctetString	10.0.8.16...
doName.2	DO1	OctetString	10.0.8.16...
doName.3	DO2	OctetString	10.0.8.16...
doName.4	DO3	OctetString	10.0.8.16...
doName.5	DO4	OctetString	10.0.8.16...
doName.6	DO5	OctetString	10.0.8.16...
doValue.1	off (0)	Integer	10.0.8.16...
doValue.2	on (1)		16...
doValue.3	off (0)		16...
doValue.4	off (0)		16...
doValue.5	off (0)		16...
doValue.6			
doIndex.1			
doIndex.2			
doIndex.3			
doIndex.4			
doIndex.5			
doIndex.6			
doName.1			

SNMP SET

OID: .1.3.6.1.4.1.34321.20.1.2.2.1.3.1

Data Type: Integer

Value: {off(0), on(1)}

Buttons: Ok, Cancel

After setting the value, execute the Walk command by right-clicking the **iso.org.dod.internet** folder on the left side of the window to update the value.

Set the outputs of the AO channel – the SET command

To do: Right-click the **aoValue** entry in the **Result Table** and click **Set** to display the **SNMP SET** dialog box. Enter the value **1.000** (output 1V) in the **Value** field to set the AO value.

Name/OID	Value	Type	IP:Port /
snmpEnableAuthenTraps.0	disabled (2)	Integer	192.168.1...
.1.3.6.1.2.1.11.31.0	0	Counter32	192.168.1...
.1.3.6.1.2.1.11.32.0	0	Counter32	192.168.1...
modelName.0	P/ET-2228	OctetString	192.168.1...
aliasName.0	EtherIO	OctetString	192.168.1...
firmwareVersion.0	v01.6.0 [20221013]	OctetString	192.168.1...
webServerPort.0	80	Integer	192.168.1...
modbusTcpPort.0	502	Integer	192.168.1...
modbusTcpNetID.0	1	Integer	192.168.1...
aoIndex.1	1	Integer	192.168.1...
aoIndex.2	2	Integer	192.168.1...
aoIndex.3	3	Integer	192.168.1...
aoIndex.4	4	Integer	192.168.1...
aoIndex.5	5	Integer	192.168.1...
aoIndex.6	6	Integer	192.168.1...
aoIndex.7	7	Integer	192.168.1...
aoIndex.8	8	Integer	192.168.1...
aoName.1	AO0	OctetString	192.168.1...
aoName.2	AO1	OctetString	192.168.1...
aoName.3	AO2	OctetString	192.168.1...
aoName.4	AO3	OctetString	192.168.1...
aoName.5	AO4	OctetString	192.168.1...
aoName.6	AO5	OctetString	192.168.1...
aoName.7	AO6	OctetString	192.168.1...
aoName.8	AO7	OctetString	192.168.1...
aoHexValue.1	+0.000V	OctetString	192.168.1...
aoHexValue.2	+0.000V	OctetString	192.168.1...
aoHexValue.3	+0.000V	OctetString	192.168.1...
aoHexValue.4	+0.000V	OctetString	192.168.1...
aoHexValue.5	+0.000V	OctetString	192.168.1...
aoHexValue.6	+0.000V	OctetString	192.168.1...
aoHexValue.7	+0.000V	OctetString	192.168.1...
aoHexValue.8	+0.000V	OctetString	192.168.1...
aoHexValue.8	(S		

The image shows a context menu for the 'aoHexValue.1' entry in the table. The 'Set' option is highlighted with a red circle and an arrow labeled '1'. Below the table, the 'SNMP SET' dialog box is open, showing the 'Value' field with '1.000' entered, also circled in red and labeled '2'. The 'Data Type' is set to 'OctetString'.

After completing the setting, execute the **Walk** command by right-clicking the **iso.org.dod.internet** folder on the left side of the window to update the value.

aoName.7	AO6	OctetString	192.168....
aoName.8	AO7	OctetString	192.168....
aoHexValue.1	+1.001V	OctetString	192.168....
aoHexValue.2	+0.000V	OctetString	192.168....
aoHexValue.3	+0.000V	OctetString	192.168....

4.18.4 SNMP Trap Example

Step 1 Click **Tools** → **Trap Receiver** on the menu bar to display the window for receiving the Trap messages.

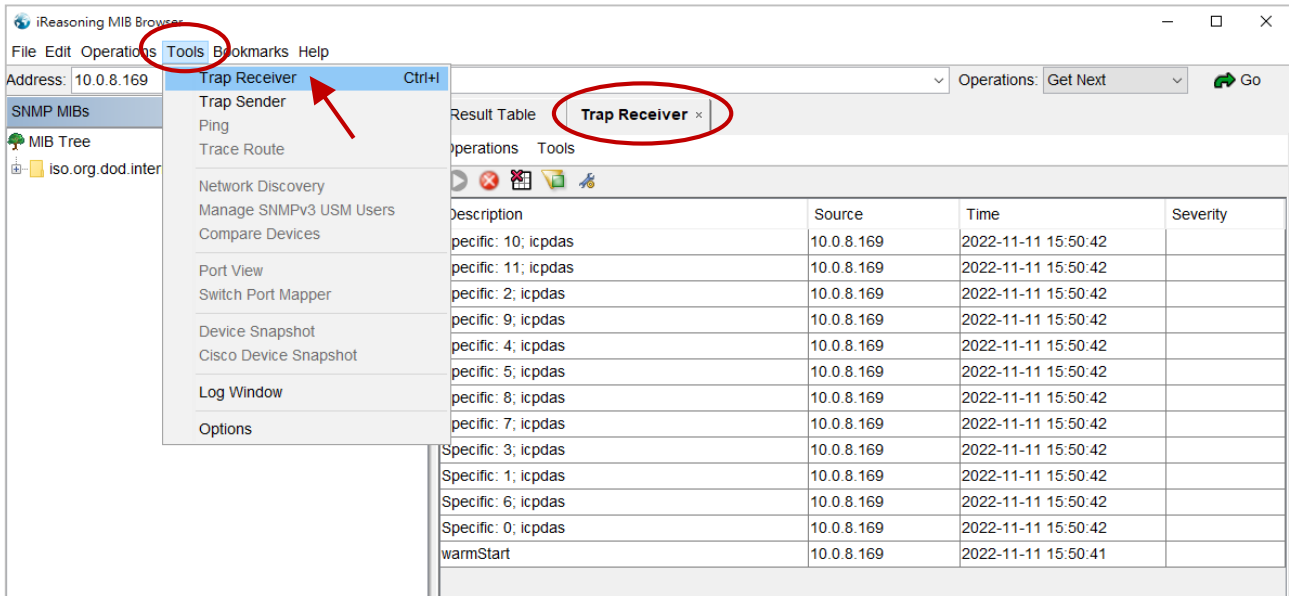

Step 2 The Trap types for the alarms that receive from the ET-2200 module are as follows.

1. **Cold Start Trap:**

The Cold Start Trap will be sent when the module restarts after it has been completely powered off.

2. **Warm Start Trap:**

The Warm Start Trap will be sent when the module restarts without turning off the power. For example, the reboot command or the watchdog mechanism.

3. **Specific Trap (DI/DO/AO State-Change):**

When the specified DO/DI/AO channel is enabled, if the I/O status changes (e.g., ON/OFF or value change), a Trap message with a Specific ID, source IP, and time will be sent. This makes it easier to analyze the cause of the alarm and handle it appropriately.

Click the Trap message to view the details

Description	Source	Time	Severity
Specific: 1; icpdas	10.0.8.169	2022-11-14 14:22:58	
Specific: 1; icpdas	10.0.8.169	2022-11-14 14:22:57	

Source:	10.0.8.169	Timestamp:	1 hour 4 minutes 48 seconds	SNMP Version:	1
Enterprise:	icpdas	Community:	public		
Specific:	1	Generic:	enterpriseSpecific		
Variable Bindings:					
Name:	trapMessage				
Value:	[OctetString] DO0=1				
Description:					

Item	Description
Source	The IP address of the Trap from the device
Timestamp	How much time has passed after the module starts
SNMP Version	The version of SNMP
Enterprise	The name of the enterprise
Community	SNMP community name according to the Trap Community setting on the ET-2200.
Specific	Specific ID
Generic	Generic ID
Name	The generic name for the Trap
Value	The I/O channel and status value of the module (e.g., 0 = OFF, 1 = ON, or an AO value)

4.18.5 SNMP Problem Solving

Unable to receive the Trap message from the device

1. Check the setting of the Windows firewall or the Anti-virus software. These functions can be disabled during the testing.
2. Check the setting of the Trap port. Using **iReasoning MIB Browser** as an example,

Click the **Trap Receiver Settings** button on the **Trap Receiver** page to open the window. Then, confirm the Trap Port, Bind IP, and Transport settings. The ET-2200 uses the default Trap port 162 according to the SNMP specification.

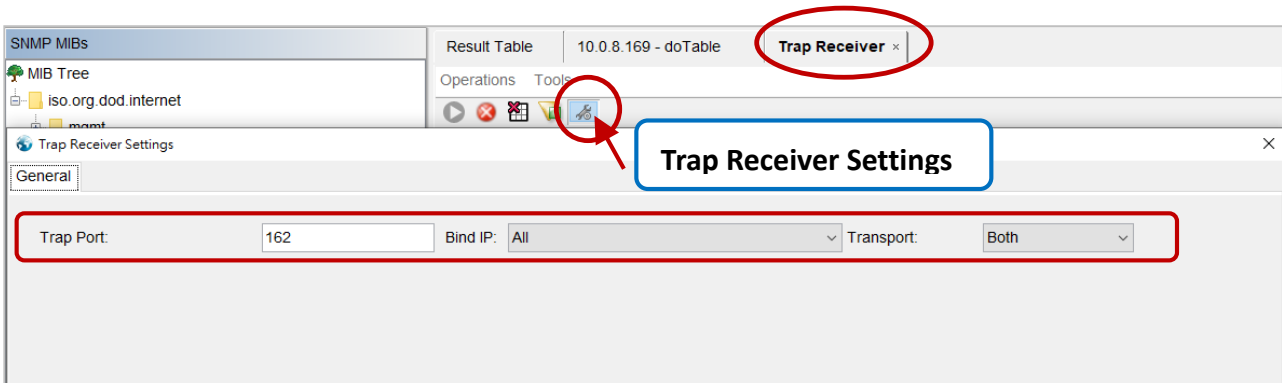

3. Disable Windows SNMP Trap Service.

Note:

The configuration screen may be different depending on the Windows version. The following screens are on Windows 10.

Step 1 Open the **Control Panel** window and click **Administrative Tools**.

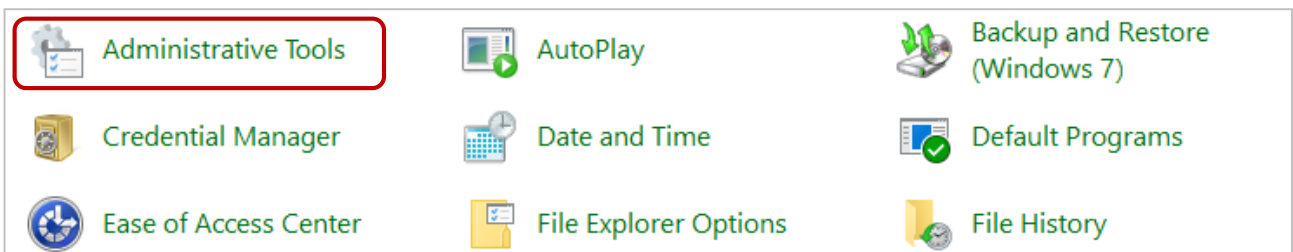

Step 2 Double-click the **Services** icon.

Registry Editor	2019/12/7 下午 05:09	Shortcut	2 KB
Resource Monitor	2019/12/7 下午 05:09	Shortcut	2 KB
Services	2019/12/7 下午 05:09	Shortcut	2 KB
System Configuration	2019/12/7 下午 05:09	Shortcut	2 KB
System Information	2019/12/7 下午 05:09	Shortcut	2 KB
Task Scheduler	2019/12/7 下午 05:09	Shortcut	2 KB
Windows Defender Firewall with Advanc...	2019/12/7 下午 05:08	Shortcut	2 KB
Windows Memory Diagnostic	2019/12/7 下午 05:09	Shortcut	2 KB

Step 3 Double-click the **SNMP Trap** and confirm the **Startup type** is set to “**Disabled**” and the **Service status** is set to “**Stopped**”.

The screenshot shows the Windows Services console with the 'SNMP Trap' service selected. The 'SNMP Trap Properties (Local Computer)' dialog box is open, showing the following details:

- Service name: SNMPTRAP
- Display name: SNMP Trap
- Description: Receives trap messages generated by local or remote Simple Network Management Protocol (SNMP) agents and forwards the messages to SNMP management programs running on this computer. If this service is stopped, SNMP-based programs on this computer will not receive SNMP trap messages. If this service is disabled, any services that explicitly depend on it will fail to start.
- Path to executable: C:\WINDOWS\System32\snmptrap.exe
- Startup type: Disabled
- Service status: Stopped

Buttons for Start, Stop, Pause, and Resume are visible. The Start parameters field is empty.

5. I/O Pair Connection Applications

The ET-2200 series modules can be used to create DI-to-DO pair connections via the Ethernet. Once the configuration is complete, the modules can then poll the status of the local DI channels and then use the Modbus/TCP protocol to continuously write to a remote DO device in the background. This is useful when connecting digital I/O devices that do not themselves have Ethernet capability. The following will describe how to correctly configure the I/O pair-connection function.

5.1 One Module Polling the Remote DI/DO (1-to-1, Pull / Push Mode)

Step 1: Connect the device to a Network, a PC, and a Power supply.

Confirm that the ET-2200 series modules are functioning correctly. Refer to [Chapter 3 “Getting Started”](#) for more details. An example configuration is shown below:

Note that the ET-2260 module is used in this example.

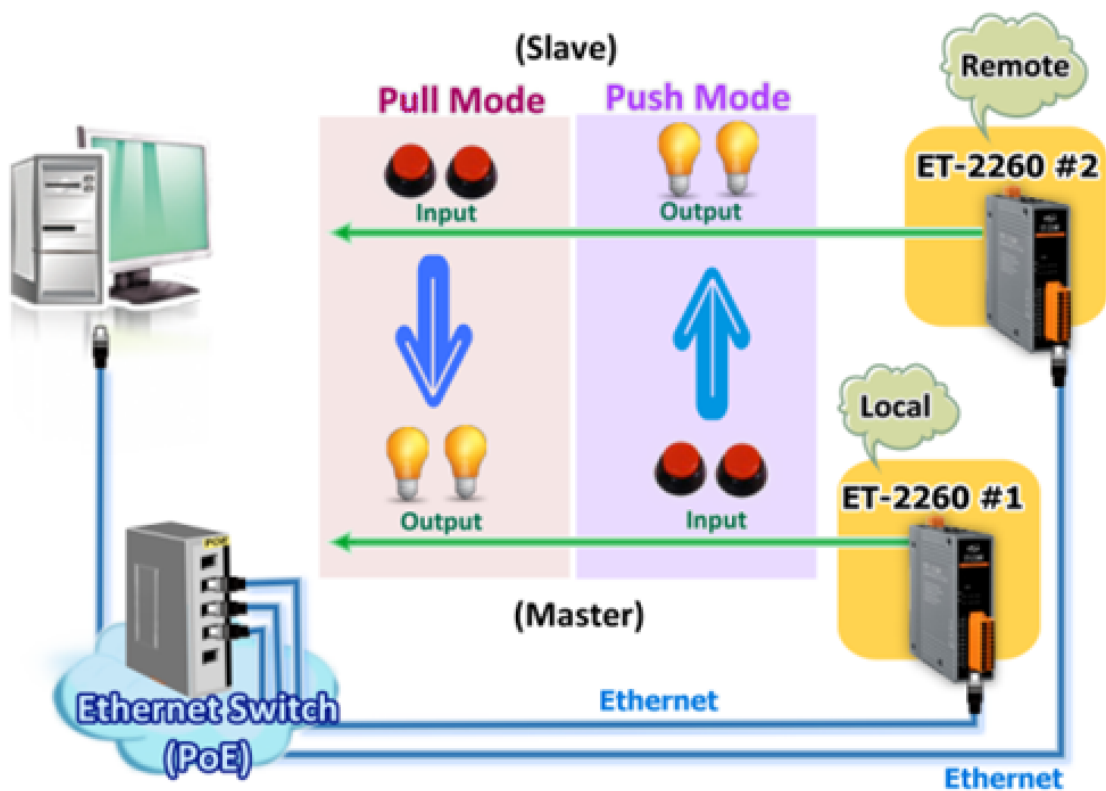

Step 2: Configure the Ethernet Settings

Contact your Network Administrator to obtain the correct network configuration information for the ET-2200 series modules (e.g., ET-2260 #1 and #2), such as the IP Address, Subnet Mask, and Gateway details. Refer to [Section 3.3 “Configuring the Network Settings”](#) for more details.

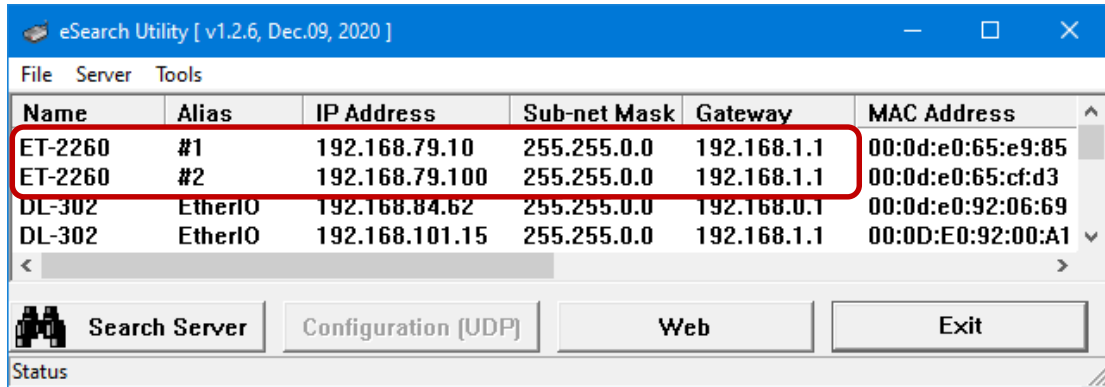

Step 3: Configure the I/O Pair connection on the Web Server

1. In the eSearch Utility, select the **ET-2260#1** module and then click the **“Web”** button to launch the browser program and connect to the web server.
2. Enter the password in the Login password field (**the default password is “Admin”**), and then click the **“Submit”** button to display the Web configuration page.

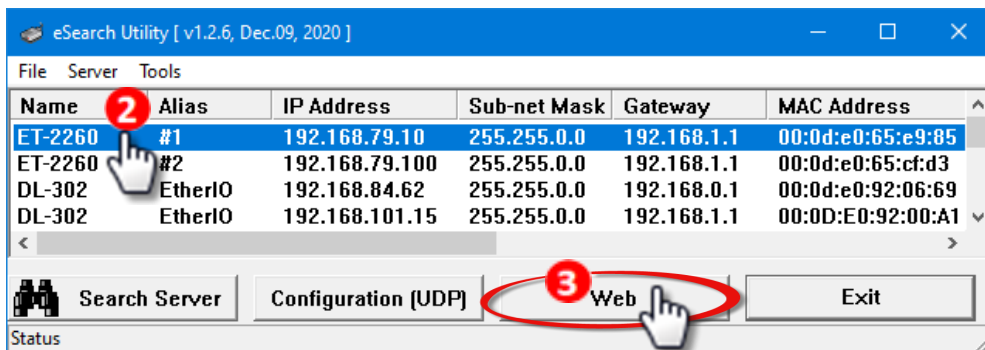

3. Click the “Pair” tab to display the I/O Pair-connection Settings page.

Ethernet I/O Module
 Home | Network | I/O Settings | Sync | PWM | **Pair** | Filter | Monitor | Password | Logout
 MQTT (Topics: DO | DI) | SNMP

Model Name	ET-2260	Alias Name	EtherIO
Firmware Version	v2.4.0 [Sep.06 2022]	MAC Address	00-0d-e0-65-e9-85
IP Address	192.168.15.60	Initial Switch	ON
TCP Timeout (Socket Watchdog, Seconds)	180	System Timeout (Network Watchdog, Seconds)	0

5.1.1 Pull Mode

1. In the “Pair-connection Settings”, select “PULL” from the “Enable Mode” dropdown menu and select the box to enable the function.
2. Enter both the IP address and TCP port number of the remote ET-2260#2 module in the “Remote IP...: Port” field.
3. Enter the amount of DI used on the remote ET-2260#2 module in the “IO Count” field.

Example of the PULL mode (Remote DI to Local DO)
 Enter **2** in the **IO Count** field and enter **0** in both **Local/Remote IO Address** fields which means **DI0** and **DI1** of ET-2260#2 mapping to **DO0** and **DO1** of ET-2260#1.

4. Select “0x: Coil Output/DO” and enter a DO address in the “Local IO Address” field.
5. Select “1x: Discrete Input/DI” and enter a DI address in the “Remote IO Address” field.
6. Click the “Submit 1-8” button to complete the configuration.

Pair-Connection Settings: Submit 1-8 9-16 |

#	Enable Mode	Remote IPv4 / IPv6 / Host Name (Max. 127 chars) : Port	Net ID	Scan Time (ms)	IO Count	Local IO Address	Remote IO Address	Network Protocol
01	<input checked="" type="checkbox"/> PULL	192.168.79.100 : 502	1	1000	2	0x:Coil Ot 0	1x:Discret 0	TCPv4
02	<input type="checkbox"/> PULL	: 502	1	1000	1	0x:Coil Ot 0	0x:Coil Ot 0	TCPv4
03	<input type="checkbox"/> PULL	: 502	1	1000	1	0x:Coil Ot 0	0x:Coil Ot 0	TCPv4
04	<input type="checkbox"/> PULL	: 502	1	1000	1	0x:Coil Ot 0	0x:Coil Ot 0	TCPv4
05	<input type="checkbox"/> PULL	: 502	1	1000	1	0x:Coil Ot 0	0x:Coil Ot 0	TCPv4

5.1.2 Push Mode

1. In the “Pair-connection Settings”, select “PUSH” from the “Enable Mode” dropdown menu and select the box to enable the function.
2. Enter both the IP address and TCP port number of the remote ET-2260#2 module in the “Remote IP...: Port” field.
3. Enter the amount of DI used on the ET-2260#1 module in the “IO Count” field.

Example of the PUSH mode (Local DI to Remote DO)
 Enter **2** in the **IO Count** field and enter **0** in both **Local/Remote IO Address** fields which means **DI0** and **DI1** of **ET-2260#1** mapping to **DO0** and **DO1** of **ET-2260#2**.

4. Select “1x: Discrete Input/DI” and enter a DI address in the “Local IO Address” field.
 Select “0x: Coil Output/DO” and enter a DO address in the “Remote IO Address” field
5. Select the Modbus protocol (e.g., **TCPv4**) from the “Network Protocol” dropdown menu.
6. Click the “Submit 1-8” button to complete the configuration.

Pair-Connection Settings: Submit 1-8 9-16 |

#	Enable Mode	Remote IPv4 / IPv6 / Host Name (Max. 127 chars) : Port	Net ID	Scan Time (ms)	IO Count	Local IO Address	Remote IO Address	Network Protocol
01	<input type="checkbox"/> PULL	192.168.79.100 : 502	1	1000	2	0x:Coil Ot 0	1x:Discret 0	TCPv4
02	<input checked="" type="checkbox"/> PUSH	192.168.79.100 : 502	1	1000	2	1x:Discret 0	0x:Coil Ot 0	TCPv4
03	<input type="checkbox"/> PULL	: 502	1	1000	1	0x:Coil Ot 0	0x:Coil Ot 0	TCPv4

5.2 Two Modules Pushing the Local DI to each other (1-to-1, Push Mode)

Step 1: Connect the device to a Network, a PC, and a Power supply.

Confirm that the ET-2200 series modules are functioning correctly. Refer to [Chapter 3 “Getting Started”](#) for more details. An example configuration is shown below:

Note that the ET-2260 module is used in this example.

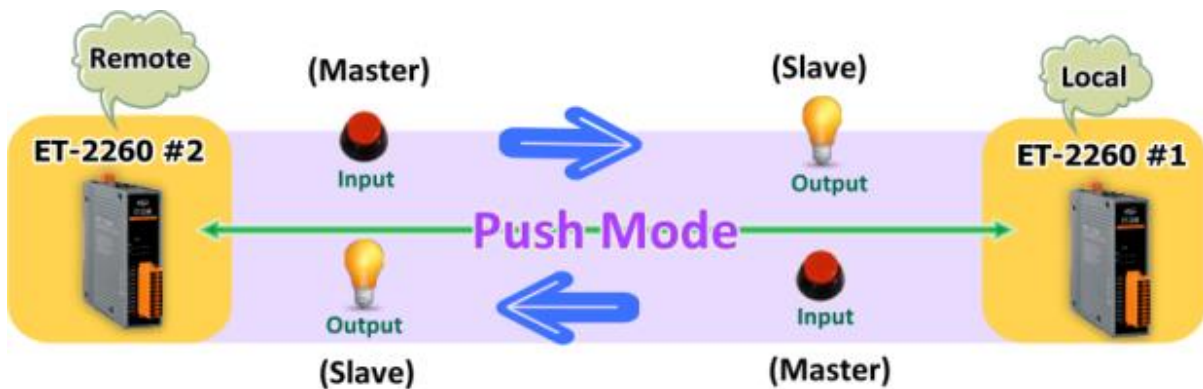

Step 2: Configure the Ethernet Settings

Contact your Network Administrator to obtain the correct network configuration information for the ET-2200 series modules (e.g., ET-2260 #1 and #2), such as the IP Address, Subnet Mask, and Gateway details. Refer to [Section 3.3 “Configuring the Network Settings”](#) for more details.

Name	Alias	IP Address	Sub-net Mask	Gateway	MAC Address
ET-2260	#1	192.168.79.10	255.255.0.0	192.168.1.1	00:0d:e0:65:e9:85
ET-2260	#2	192.168.79.100	255.255.0.0	192.168.1.1	00:0d:e0:65:cf:d3
DL-302	EtherIO	192.168.84.62	255.255.0.0	192.168.0.1	00:0d:e0:92:06:69
DL-302	EtherIO	192.168.101.15	255.255.0.0	192.168.1.1	00:0D:E0:92:00:A1

The screenshot shows the 'eSearch Utility' window with a table of network configurations. The first two rows, corresponding to ET-2260 modules #1 and #2, are highlighted with a red box. Below the table are buttons for 'Search Server', 'Configuration (UDP)', 'Web', and 'Exit'. The status bar at the bottom shows 'Status'.

Step 3: Configure the I/O Pair connection on the ET-2260 #1 module

1. In the eSearch Utility, select the **ET-2260#1** module and then click the **“Web”** button to launch the browser program and connect to the web server.
2. Enter the password in the Login password field (**the default password is “Admin”**), and then click the **“Submit”** button to display the Web configuration page.
3. Click the **“Pair”** tab to display the I/O Pair-connection Settings page.

Refer to [Section 5.1 – Step2 and 3](#) for instructions on how to perform the above procedures.

4. In the **“Pair-connection Settings”**, select **“PUSH”** from the **“Enable Mode”** dropdown menu and select the box to enable the function.
5. Enter both the IP address and TCP port number of the remote **ET-2260#2** module in the **“Remote IP...: Port”** field.
6. Enter the amount of **DI** used on the **ET-2260#1** module in the **“IO Count”** field.

Example of the PUSH mode (Local DI to Remote DO)
 Enter **1** in the **IO Count** field and enter **0** in both **“Local/Remote IO Address”** fields which means **DI0** of **ET-2260#1** mapping to **DO0** of **ET-2260#2**.

7. Select **“1x: Discrete Input/DI”** and enter a DI address in the **“Local IO Address”** field. Select **“0x: Coil Output/DO”** and enter a DO address in the **“Remote IO Address”** field
8. Select the Modbus protocol (e.g., **TCPv4**) from the **“Network Protocol”** dropdown menu.
9. Click the **“Submit 1-8”** button to complete the configuration.

Pair-Connection Settings: Submit 1-8 9-16 |

#	Enable Mode	Remote IPv4 / IPv6 / Host Name (Max. 127 chars) : Port	Net ID	Scan Time (ms)	IO Count	Local IO Address	Remote IO Address	Network Protocol
01	<input checked="" type="checkbox"/> PUSH	192.168.79.100 : 502	1	1000	1	1x: Discret 0	0x: Coil Ot 0	TCPv4
02	<input type="checkbox"/> PULL	: 502	1	1000	1	0x: Coil Ot 0	0x: Coil Ot 0	TCPv4
03	<input type="checkbox"/> PULL	: 502	1	1000	1	0x: Coil Ot 0	0x: Coil Ot 0	TCPv4

Step 4: Configure the I/O Pair connection on the ET-2260 #2 module

1. In the eSearch Utility, select the **ET-2260#2** module and then click the “**Web**” button to launch the browser program and connect to the web server.
2. Enter the password in the Login password field (**the default password is “Admin”**), and then click the “**Submit**” button to display the Web configuration page.
3. Click the “**Pair**” tab to display the I/O Pair-connection settings page.

Refer to [Section 5.1 – Step2 and 3](#) for instructions on how to perform the above procedures.

4. In the “**Pair-connection Settings**”, select “**PUSH**” from the “**Enable Mode**” dropdown menu and select the box to enable the function.
5. Enter both the IP address and TCP port number of the remote **ET-2260#1** module in the “**Remote IP...: Port**” field.
6. Enter the amount of **DI** used on the **ET-2260#2** module in the “**IO Count**” field.

Example of the **PUSH** mode (Local DI to Remote DO)
 Enter **1** in the **IO Count** field and enter **0** in both “**Local/Remote IO Address**” fields which means **DI0** of **ET-2260#2** mappings to **DO0** of **ET-2260#1**.

7. Select “**1x: Discrete Input/DI**” and enter a DI address in the “**Local IO Address**” field. Select “**0x: Coil Output/DO**” and enter a DO address in the “**Remote IO Address**” field
8. Select the Modbus protocol (e.g., **TCPv4**) from the “**Network Protocol**” dropdown menu.
9. Click the “**Submit 1-8**” button to complete the configuration.

Pair-Connection Settings: Submit 1-8 9-16 |

#	Enable Mode	Remote IPv4 / IPv6 / Host Name (Max. 127 chars) : Port	Net ID	Scan Time (ms)	IO Count	Local IO Address	Remote IO Address	Network Protocol
01	<input checked="" type="checkbox"/> PUSH	192.168.79.10 : 502	1	1000	1	1x:Discret 0	0x:Coil Ot 0	TCPv4
02	<input type="checkbox"/> PULL	: 502	1	1000	1	0x:Coil Ot 0	0x:Coil Ot 0	TCPv4
03	<input type="checkbox"/> PULL	: 502	1	1000	1	0x:Coil Ot 0	0x:Coil Ot 0	TCPv4
04	<input type="checkbox"/> PULL	: 502	1	1000	1	0x:Coil Ot 0	0x:Coil Ot 0	TCPv4
05	<input type="checkbox"/> PULL	: 502	1	1000	1	0x:Coil Ot 0	0x:Coil Ot 0	TCPv4

5.3 Several Modules Pulling the Remote DI (M-to-1) (Pull Mode)

Step 1: Connect the device to a Network, a PC, and a Power supply.

Confirm that the ET-2200 series modules and remote slave device are functioning correctly. Refer to Chapter 3 “Getting Started” for more details. An example configuration is shown below:

Note that ET-2260 and ET-7255 modules are used in this example.

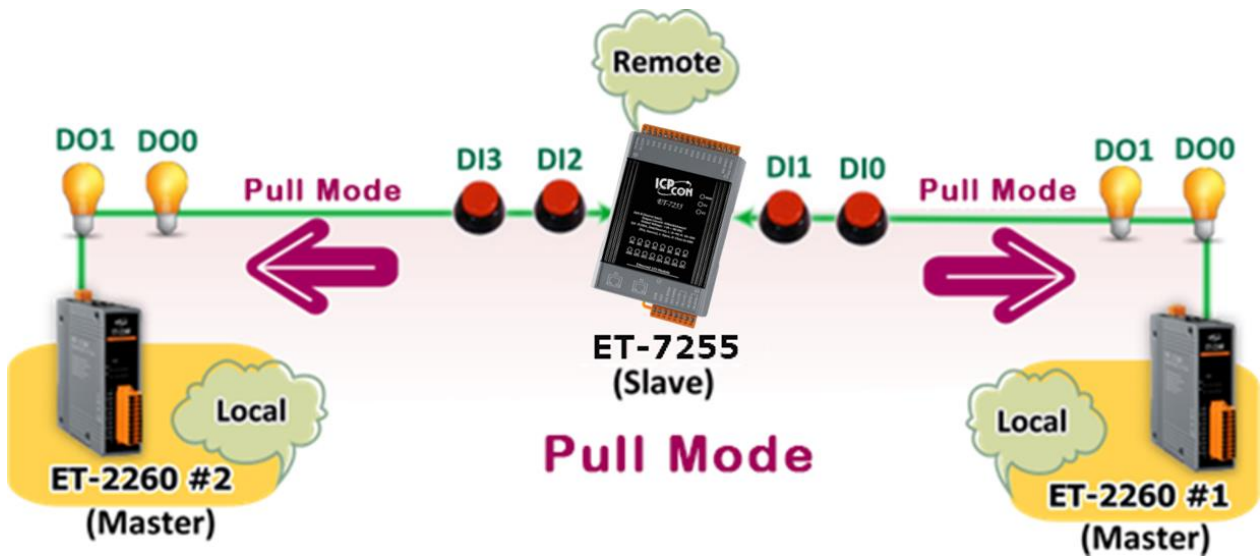

Step 2: Configure the Ethernet Settings

Contact your Network Administrator to obtain the correct network configuration information for the ET-2200 series modules and remote slave device (e.g., ET-2260 #1, #2, and ET-7255), such as the IP Address, Subnet Mask, and Gateway details. Refer to Section 3.3 “Configuring the Network Settings” for more details.

Name	Alias	IP Address	Sub-net Mask	Gateway	MAC Address
ET-2260	#1	192.168.79.10	255.255.0.0	192.168.1.1	00:0d:e0:65:e9:85
ET-2260	#2	192.168.79.100	255.255.0.0	192.168.1.1	00:0d:e0:65:cf:d3
DL-302	EtherIO	192.168.84.62	255.255.0.0	192.168.0.1	00:0d:e0:92:06:69
DI-302	EtherIO	192.168.101.15	255.255.0.0	192.168.1.1	00:0d:e0:92:00:a1
ET-7255/PET-7255	Slave	192.168.79.55	255.255.0.0	192.168.1.1	00:0d:e0:65:ed:d1

Buttons at the bottom: Search Server, Configuration (UDP), Web, Exit. Status:

Step 3: Configure the I/O Pair connection on the ET-2260 #1 module

1. In the eSearch Utility, select the **ET-2260#1** module and then click the **“Web”** button to launch the browser program and connect to the web server.
2. Enter the password in the Login password field (**the default password is “Admin”**), and then click the **“Submit”** button to display the Web configuration page.
3. Click the **“Pair”** tab to display the I/O Pair-connection settings page.

Refer to [Section 5.1 – Step2 and 3](#) for instructions on how to perform the above procedures.

4. In the **“Pair-connection Settings”**, select **“PULL”** from the **“Enable Mode”** dropdown menu and select the box to enable the function.
5. Enter both the IP address and TCP port number of the remote **ET-7255** module in the **“Remote IP...: Port”** field.
6. Enter the amount of **DI** used on the remote **ET-7255** module in the **“IO Count”** field.

Example of the PULL mode (Remote DI to Local DO)
 Enter **2** in the **IO Count** field and enter **0** in both **Local/Remote IO Address** fields which means **DI0** and **DI1** of **ET-7255** mapping to **DO0** and **DO1** of **ET-2260#1**.

7. Select **“0x: Coil Output/DO”** and enter a DO address (e.g., 0) in the **“Local IO Address”** field. Select **“1x: Discrete Input/DI”** and enter a DI address (e.g., 0) in the **“Remote IO Address”** field.
8. Select the Modbus protocol (e.g., **TCPv4**) from the **“Network Protocol”** dropdown menu.
9. Click the **“Submit 1-8”** button to complete the configuration.

Pair-Connection Settings: Submit 1-8 9-16 |

#	Enable Mode	Remote IPv4 / IPv6 / Host Name (Max. 127 chars) : Port	Net ID	Scan Time (ms)	IO Count	Local IO Address	Remote IO Address	Network Protocol
01	<input checked="" type="checkbox"/> PULL	192.168.79.55 : 502	1	1000	2	0x:Coil Out 0	1x:Discret 0	TCPv4
02	<input type="checkbox"/> PULL	: 502	1	1000	1	0x:Coil Out 0	0x:Coil Out 0	TCPv4
03	<input type="checkbox"/> PULL	: 502	1	1000	1	0x:Coil Out 0	0x:Coil Out 0	TCPv4

Step 4: Configure the I/O Pair connection on the ET-2260 #2 module

1. In the eSearch Utility, select the **ET-2260#2** module and then click the **“Web”** button to launch the browser program and connect to the web server.
2. Enter the password in the Login password field (**the default password is “Admin”**), and then click the **“Submit”** button to display the Web configuration page.
3. Click the **“Pair”** tab to display the I/O Pair-connection Settings page.

Refer to [Section 5.1 – Step2 and 3](#) for instructions on how to perform the above procedures.

7. In the **“Pair-connection Settings”**, select **“PULL”** from the **“Enable Mode”** dropdown menu and select the box to enable the function.
8. Enter both the IP address and TCP port number of the remote **ET-7255** module in the **“Remote IP...: Port”** field.
9. Enter the amount of **DI** used on the remote **ET-7255** module in the **“IO Count”** field.

Example of the PULL mode (Remote DI to Local DO)
 Enter **2** in the **IO Count** field and enter **0/2** in both **Local/Remote IO Address** fields which means **DI0** and **DI1** of ET-7255 mapping to **DO0** and **DO1** of ET-2260#2.

10. Select **“0x: Coil Output/DO”** and enter a DO address (e.g., 0) in the **“Local IO Address”** field. Select **“1x: Discrete Input/DI”** and enter a DI address (e.g., 2) in the **“Remote IO Address”** field.
11. Select the Modbus protocol (e.g., **TCPv4**) from the **“Network Protocol”** dropdown menu.
12. Click the **“Submit 1-8”** button to complete the configuration.

Pair-Connection Settings: Submit 1-8 9-16 |

#	Enable Mode	Remote IPv4 / IPv6 / Host Name (Max. 127 chars) : Port	Net ID	Scan Time (ms)	IO Count	Local IO Address	Remote IO Address	Network Protocol
01	<input checked="" type="checkbox"/> PULL	192.168.79.55 : 502	1	1000	2	0x:Coil Ot 0	1x:Discret 2	TCPv4
02	<input type="checkbox"/> PULL	: 502	1	1000	1	0x:Coil Ot 0	0x:Coil Ot 0	TCPv4
03	<input type="checkbox"/> PULL	: 502	1	1000	1	0x:Coil Ot 0	0x:Coil Ot 0	TCPv4

5.4 Several Modules Pushing the Local DI (M-to-1) (Push Mode)

Step 1: Connect the device to a Network, a PC, and a Power supply.

Confirm that the ET-2200 series modules and remote slave device are functioning correctly. Refer to [Chapter 3 “Getting Started”](#) for more details. An example configuration is shown below:

Note that ET-2260 and ET-7255 modules are used in this example.

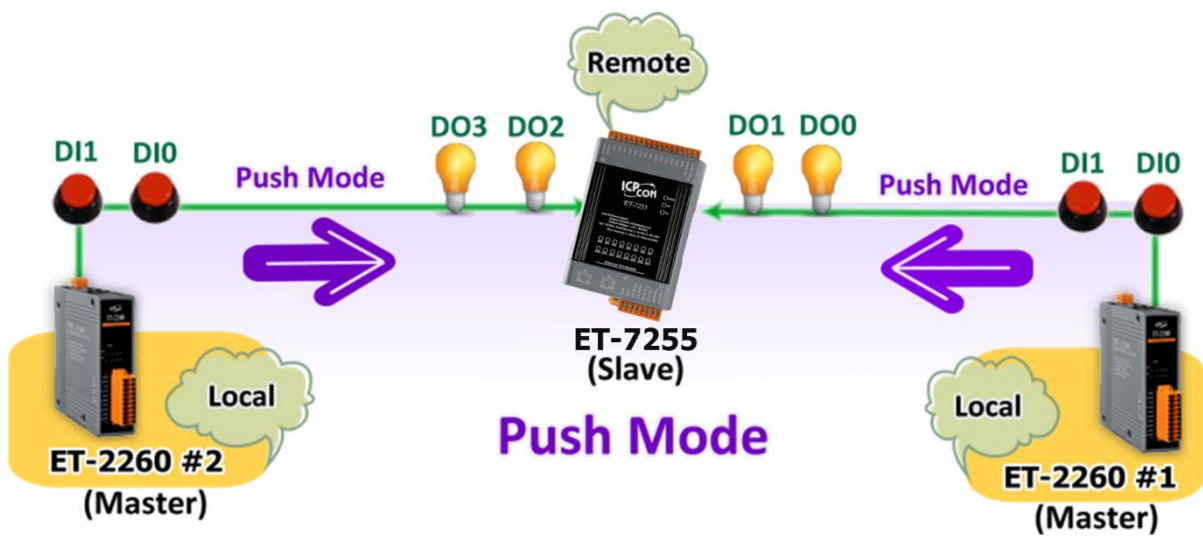

Step 2: Configure the Ethernet Settings

Contact your Network Administrator to obtain the correct network configuration information for the ET-2200 series modules and remote slave device (e.g., ET-2260 #1, #2, and ET-7255), such as the IP Address, Subnet Mask, and Gateway details. Refer to [Section 3.3 “Configuring the Network Settings”](#) for more details.

eSearch Utility [v1.2.6, Dec.09, 2020]

Name	Alias	IP Address	Sub-net Mask	Gateway	MAC Address
ET-2260	#1	192.168.79.10	255.255.0.0	192.168.1.1	00:0d:e0:65:e9:85
ET-2260	#2	192.168.79.100	255.255.0.0	192.168.1.1	00:0d:e0:65:cf:d3
DL-302	EtherIO	192.168.84.82	255.255.0.0	192.168.0.1	00:0d:e0:92:06:69
DL-302	EtherIO	192.168.101.15	255.255.0.0	192.168.1.1	00:0D:E0:02:00:A1
ET-7255/PET-7255	Slave	192.168.79.55	255.255.0.0	192.168.1.1	00:0d:e0:65:ed:d1

Search Server Configuration [UDP] Web Exit

Status

Step 3: Configure the I/O Pair connection on the ET-2260 #1 module

1. In the eSearch Utility, select the **ET-2260#1** module and then click the **“Web”** button to launch the browser program and connect to the web server.
2. Enter the password in the Login password field (**the default password is “Admin”**), and then click the **“Submit”** button to display the Web configuration page.
3. Click the **“Pair”** tab to display the I/O Pair-connection Settings page.

Refer to [Section 5.1 – Step2 and 3](#) for instructions on how to perform the above procedures.

4. In the **“Pair-connection Settings”**, select **“PUSH”** from the **“Enable Mode”** dropdown menu and select the box to enable the function.
5. Enter both the IP address and TCP port number of the remote **ET-7255** module in the **“Remote IP...: Port”** field.
6. Enter the amount of **DI** used on the **ET-2260#1** module in the **“IO Count”** field.

Example of the PUSH mode (Local DI to Remote DO)
 Enter **2** in the **IO Count** field and enter **0** in both **Local/Remote IO Address** fields which means **DI0** and **DI1** of **ET-2260#1** mapping to **DO0** and **DO1** of **ET-7255**.

7. Select **“1x: Discrete Input/DI”** and enter a DI address in the **“Local IO Address”** field. Select **“0x: Coil Output/DO”** and enter a DO address in the **“Remote IO Address”** field
8. Select the Modbus protocol (e.g., **TCPv4**) from the **“Network Protocol”** dropdown menu.
9. Click the **“Submit 1-8”** button to complete the configuration.

Pair-Connection Settings: Submit 1-8 9-16 |

#	Enable Mode	Remote IPv4 / IPv6 / Host Name (Max. 127 chars) : Port	Net ID	Scan Time (ms)	IO Count	Local IO Address	Remote IO Address	Network Protocol
01	<input checked="" type="checkbox"/> PUSH	192.168.79.55 : 502	1	1000	2	1x:Discret 0	0x:Coil Ot 0	TCPv4
02	<input type="checkbox"/> PULL	: 502	1	1000	1	0x:Coil Ot 0	0x:Coil Ot 0	TCPv4
03	<input type="checkbox"/> PULL	: 502	1	1000	1	0x:Coil Ot 0	0x:Coil Ot 0	TCPv4
04	<input type="checkbox"/> PULL	: 502	1	1000	1	0x:Coil Ot 0	0x:Coil Ot 0	TCPv4
05	<input type="checkbox"/> PULL	: 502	1	1000	1	0x:Coil Ot 0	0x:Coil Ot 0	TCPv4

Step 4: Configure the I/O Pair connection on the ET-2260 #2 module

1. In the eSearch Utility, select **ET-2260 #2 module** and then click the **“Web”** button to launch the browser program and connect to the web server.
2. Enter the password in the Login password field (**the default password is “Admin”**), and then click the **“Submit”** button to display the Web configuration page.
3. Click the **“Pair”** tab to display the I/O Pair-connection Settings page.

Refer to [Section 5.1 – Step2 and 3](#) for instructions on how to perform the above procedures.

4. In the **“Pair-connection Settings”**, select **“PUSH”** from the **“Enable Mode”** dropdown menu and select the box to enable the function.
5. Enter both the IP address and TCP port number of the remote **ET-7255** module in the **“Remote IP...: Port”** field.
6. Enter the amount of **DI** used on the **ET-2260#2** module in the **“IO Count”** field.

Example of the PUSH mode (Local DI to Remote DO)
 Enter **2** in the **IO Count** field and enter **0/2** in both **Local/Remote IO Address** fields which means **DI0** and **DI1** of **ET-2260#2** mappings to **DO2** and **DO3** of **ET-7255**.

7. Select **“1x: Discrete Input/DI”** and enter a DI address (e.g., 0) in the **“Local IO Address”** field. Select **“0x: Coil Output/DO”** and enter a DO address (e.g., 2) in the **“Remote IO Address”** field
8. Select the Modbus protocol (e.g., **TCPv4**) from the **“Network Protocol”** dropdown menu.
9. Click the **“Submit 1-8”** button to complete the configuration.

Pair-Connection Settings: Submit 1-8 9-16 |

#	Enable Mode	Remote IPv4 / IPv6 / Host Name (Max. 127 chars) : Port	Net ID	Scan Time (ms)	IO Count	Local IO Address	Remote IO Address	Network Protocol
01	<input checked="" type="checkbox"/> PUSH	192.168.79.55 : 502	1	1000	2	1x: Discret 0	0x: Coil OI 2	TCPv4
02	<input type="checkbox"/> PULL	: 502	1	1000	1	0x: Coil OI 0	0x: Coil OI 0	TCPv4
03	<input type="checkbox"/> PULL	: 502	1	1000	1	0x: Coil OI 0	0x: Coil OI 0	TCPv4
04	<input type="checkbox"/> PULL	: 502	1	1000	1	0x: Coil OI 0	0x: Coil OI 0	TCPv4
05	<input type="checkbox"/> PULL	: 502	1	1000	1	0x: Coil OI 0	0x: Coil OI 0	TCPv4

5.5 Shared Memory

The ET-2200 DIO series add a 512-byte shared memory which can be used as a tiny data concentrator to store both the AIO and DIO data (256 Registers or 4096-bit shared single memory).

Shared memory used with the Pair-Connection function can effectively lower the host load. It can also perform Bits/Registers data exchange, i.e., read data from the remote device and store them in the memory or output signals from the memory to the remote device.

Note: Shared memory is only available for the firmware v2.4.0 and later. The older version is not supported.

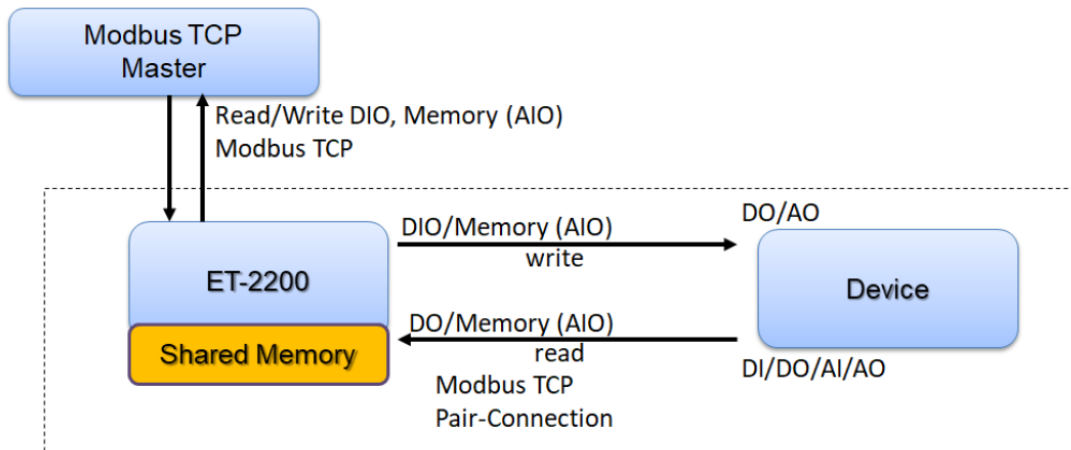

5.5.1 Address Mapping for Shared Memory

Shared Memory Register Name	3x, 4x (AIO) Register Address	Mapping (=)	Shared Memory Bit Name	0x, 1x (DIO) Bit Address
Register 0	3000	↔	Bit 0 ... Bit 15	3000 ... 3015
Register 1	3001	↔	Bit 16 ... Bit 31	3016 ... 3031
Register 2	3002	↔	Bit 32 ... Bit 47	3032 ... 3047
Register 3	3003	↔	Bit 48 ... Bit 63	3048 ... 3063
Register 4	3004	↔	Bit 64 ... Bit 79	3064 ... 3079
Register 5	3005	↔	Bit 80 ... Bit 95	3080 ... 3095
Register 6	3006	↔	Bit 96 ... Bit 111	3096 ... 3111
Register 7	3007	↔	Bit 112 ... Bit 127	3112 ... 3127
Register 8	3008	↔	Bit 128 ... Bit 143	3128 ... 3143
Register 9	3009	↔	Bit 144 ... Bit 159	3144 .. 3159
Register 10	3010	↔	Bit 160 ... Bit 175	3160 ... 3175
...				

Note: All DI, DO, AI, and AO signals shared a single memory space. The storage address starts at **3000**.

Writing 16 bits of DI/DO data to addresses **3000 – 3015** is equivalent to writing a 16-bit AI/AO register to the address **3000**.

Writing 16 bits of DI/DO data to addresses **3016 – 3031** is equivalent to writing a 16-bit AI/AO register to the address **3001**.

The correspondence of addresses is as follows, using the division to take the quotient and remove the remainder.

$$\text{AIO_Address} = (\text{DIO_Address} - 3000) / 16 + 3000$$

5.5.2 Application of spreading the load

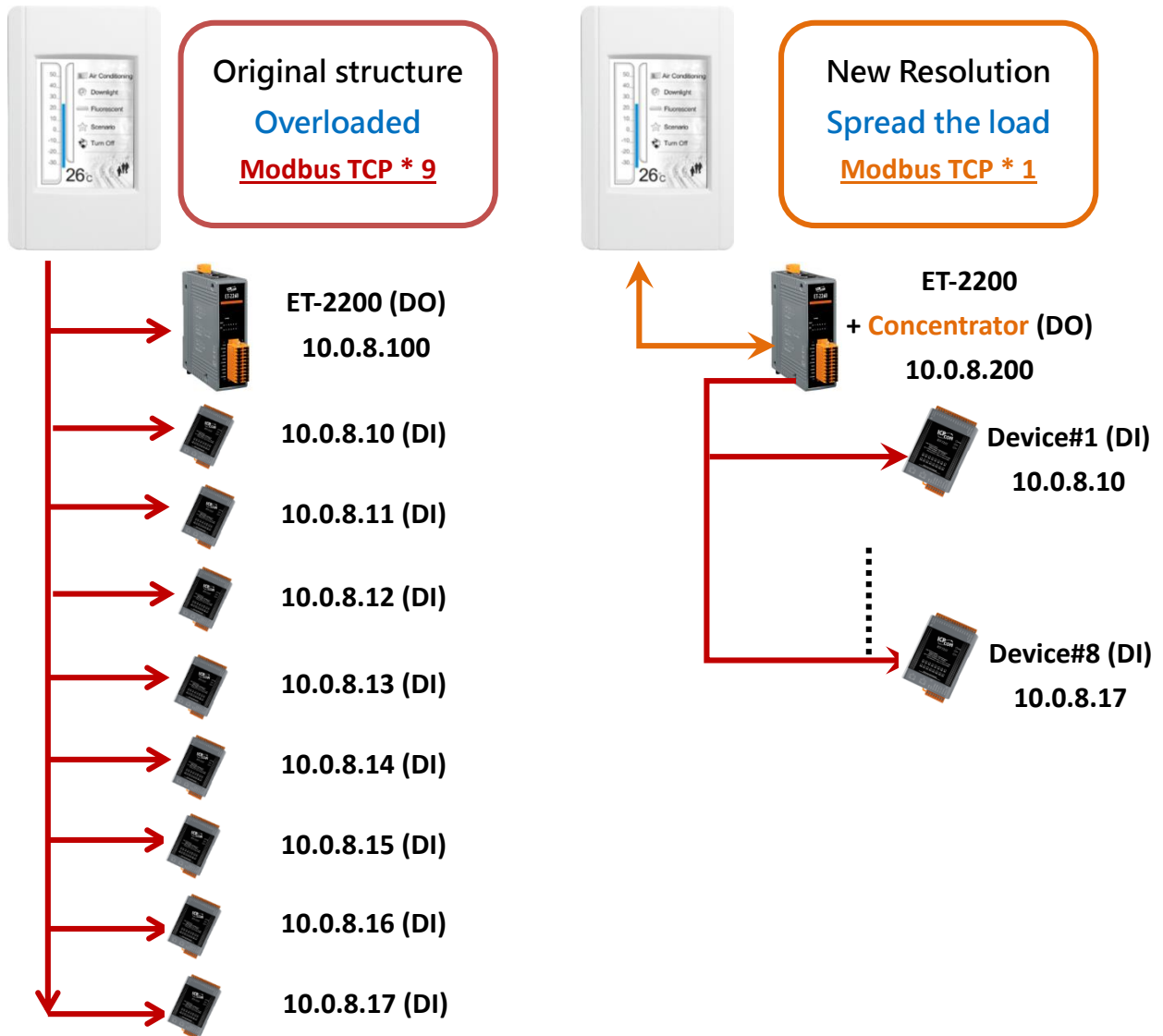

The original architecture on the left does not use the data concentrator feature, the host has to connect with all devices to exchange data (9 Modbus TCP connections in this case), and more devices will make the host overloaded.

The new architecture on the right uses the data concentrator feature on the ET-2200 series DIO module. The Pair-connection function supports up to 16 IP connections. The host can obtain the signals written in the data concentrator from Device#1 - #8 by connecting to the ET-2200 series DIO module. The number of Modbus TCP connections to the host is reduced from 9 to 1, which can effectively spread the load.

Please refer to Chapter 5 - I/O Pair Connection Application for detailed configuration.

Host	ET-2200 + Concentrator IP	Remote IP (Slave #1-8)	IO Address (Shared Memory)
	<h1>10.0.8.200</h1>	10.0.8.10	3000...3015
		10.0.8.11	3016...3031
		10.0.8.12	3032...3047
		10.0.8.13	3048...3063
		10.0.8.14	3064...3079
		10.0.8.15	3080...3095
		10.0.8.16	3096...3111
		10.0.8.17	3112...3127

Pair-Connection Settings: | [Submit 1-8](#) | [9-16](#) |

#	Enable Mode	Remote IPv4 / IPv6 / Host Name (Max. 127 chars) : Port	Net ID	Scan Time (ms)	IO Count	Local IO Address	Remote IO Address	Network Protocol
01	<input type="checkbox"/> PULL	10.0.8.10 : 502	1	1000	16	0x: Coil O 3000	1x: Discre 0	TCPv4
02	<input type="checkbox"/> PULL	10.0.8.11 : 502	1	1000	16	0x: Coil O 3016	1x: Discre 0	TCPv4
03	<input type="checkbox"/> PULL	10.0.8.12 : 502	1	1000	16	0x: Coil O 3032	1x: Discre 0	TCPv4
04	<input type="checkbox"/> PULL	10.0.8.13 : 502	1	1000	16	0x: Coil O 3048	1x: Discre 0	TCPv4
05	<input type="checkbox"/> PULL	10.0.8.14 : 502	1	1000	16	0x: Coil O 3064	1x: Discre 0	TCPv4
06	<input type="checkbox"/> PULL	10.0.8.15 : 502	1	1000	16	0x: Coil O 3080	1x: Discre 0	TCPv4
07	<input type="checkbox"/> PULL	10.0.8.16 : 502	1	1000	16	0x: Coil O 3096	1x: Discre 0	TCPv4
08	<input type="checkbox"/> PULL	10.0.8.17 : 502	1	1000	16	0x: Coil O 3112	1x: Discre 0	TCPv4

Note:
 PULL Mode = Remote to Local
 PUSH Mode = Local to Remote
 Pair-connection is disabled if the IO Count is 0 (no data)
 IO Address (base 0): 0 - 65535, no leading 0x/1x/3x/4x.

1. In this case, click to enable the Slave devices #01 ~ #08 and set them to **PULL** Mode (Remote Inputs to Local Outputs), then set the related fields.
2. Set the **Remote IP: 502**, **Net ID** (e.g., 1), **Scan Time** (e.g., 1000 ms), **IO Count** (e.g., 16), **Local/Remote IO Address**, and **Network Protocol** (e.g., TCPv4) according to your requirements. Take the **PULL** mode as an example, select “0x: Coil Output/**DO**” from the **Local IO Address** dropdown menu and enter the address of shared memory, then select “1x: Discrete Input/**DI**” from the **Remote IO Address** dropdown menu and enter the DI address of the remote device.
3. For the shared memory, the host can poll the ET-2200 with a Bit or Register address, both of which can read the same data. Accessing one register is equivalent to accessing 16 bits of data.

5.5.3 Master/Slave/MTCP/MUDP Data Exchange

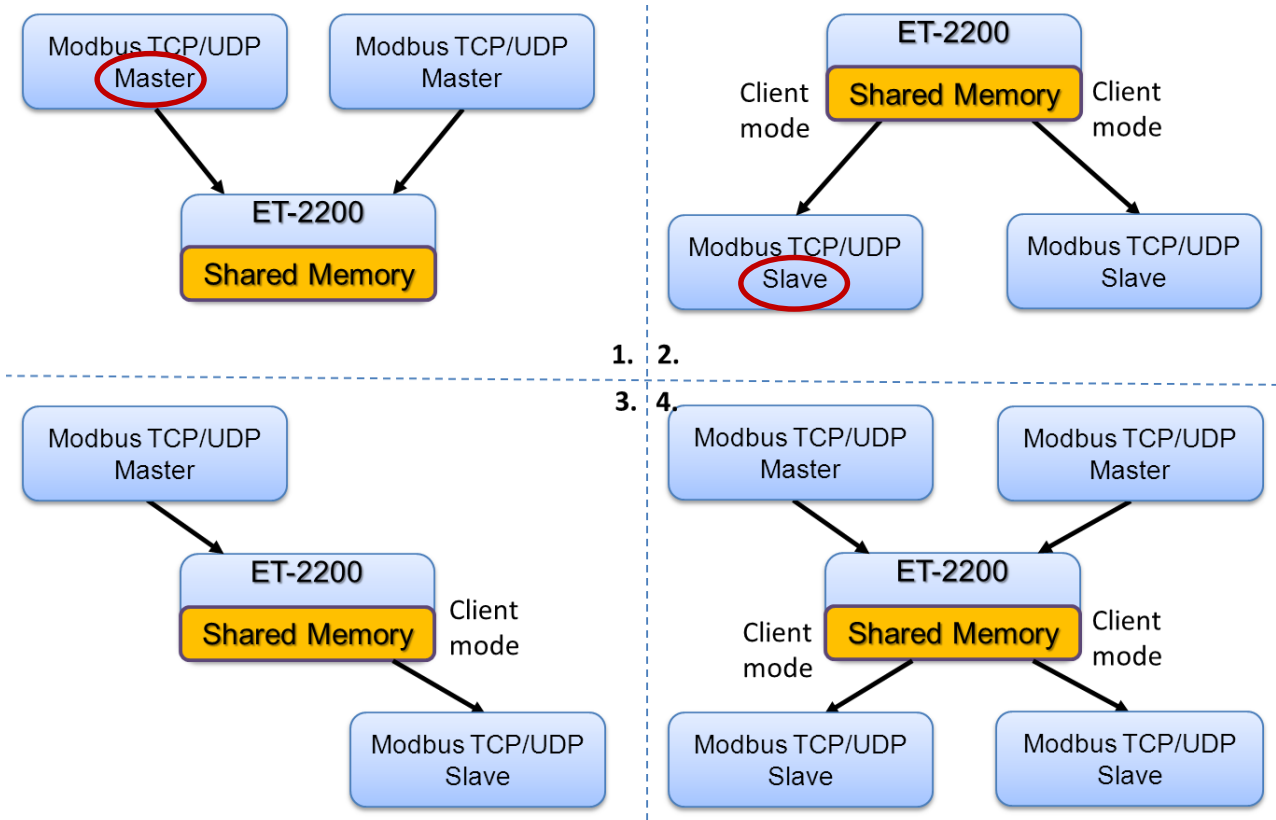

1. Two hosts can exchange data via shared memory.
2. With the Pair-connection function, two Slave devices can also exchange data via shared memory.
3. With the Pair-connection function, the host can indirectly control the Slave device via the shared memory.
4. Shared memory can be used as a concentrator for multiple hosts and Slave devices to exchange data.

5.5.4 Bits / Registers Data Exchange

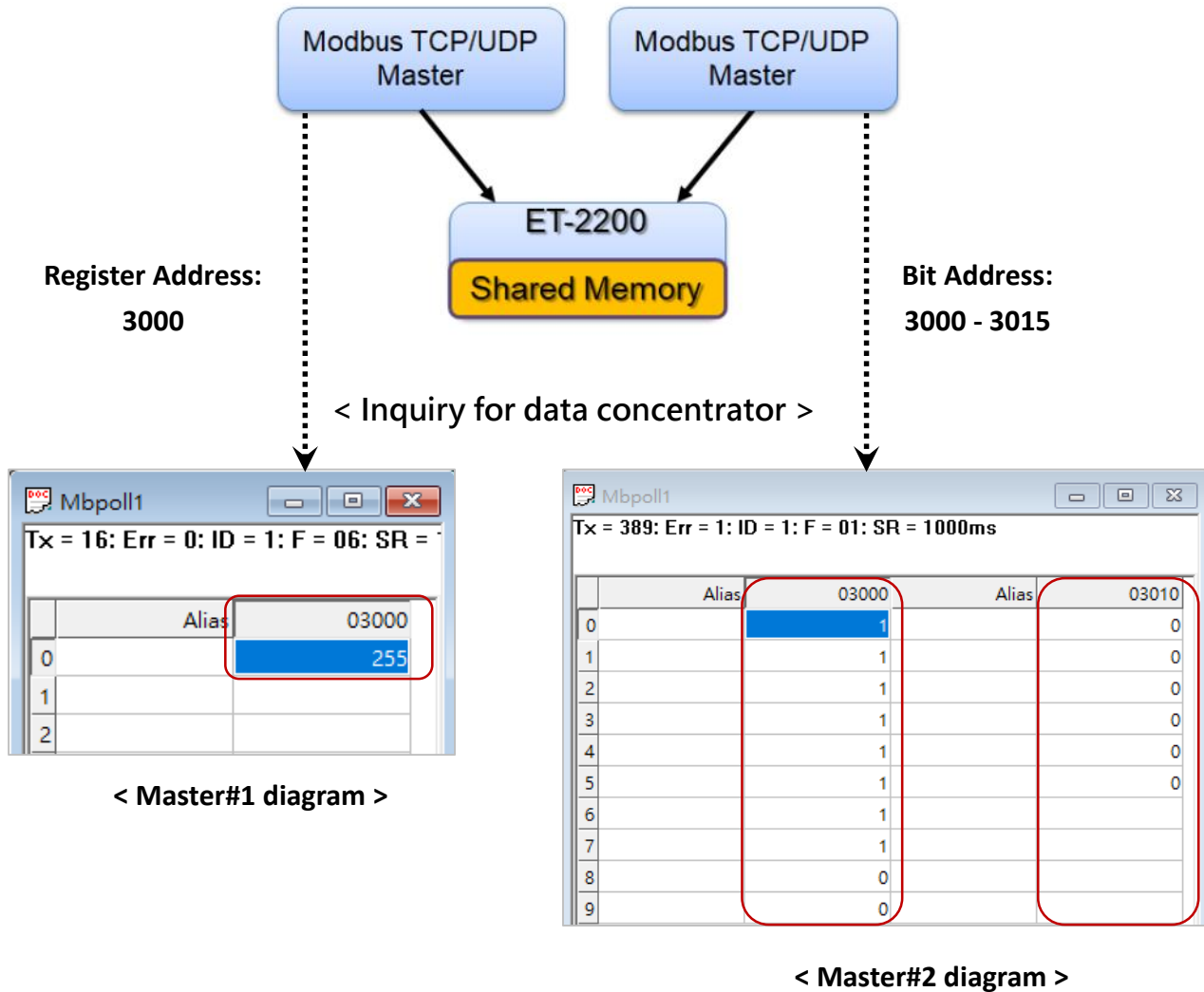

Generally, the device cannot exchange the Bit and Register data directly, but this can be achieved by using the shared memory of ET-2200 as a concentrator. As the diagram above, the Modbus Master#1 writes data **255 (0X00FF)** to the shared memory with a Register address **3000**. The Modbus Master#2 reads data from the shared memory with Bit addresses 3015 to 3000 and gets the result **0000 0000 1111 1111**.

The data stored in shared memory can be read with the Bit or Register address.

6. Modbus Information

The ET-2200 series is a family of IP-based Modbus I/O devices that allow you to remotely control DI/DO terminals via an Ethernet connection and uses a master-slave communication technique in which only one device (the master) can initiate a transaction (called queries), while other devices (slaves) respond by either supplying the requested data to the master or by taking the action requested in the query.

Most SCADA (Supervisory Control and Data Acquisition) and HMI software, such as Citect (Schneider Electric), ICONICS, iFIX, InduSoft, Intouch, Entivity Studio, Entivity Live, Entivity VLC, Trace Mode, Wizcon (EIUTIONS), and Wonderware, etc. can be used to easily integrate serial devices via the Modbus protocol.

6.1 What is Modbus TCP/IP?

Modbus is a communication protocol that was developed by Modicon Inc. in 1979. Detailed information regarding the Modbus protocol can be found at: <http://www.modbus.org>.

The different versions of the Modbus protocol used today include Modbus RTU, which is based on serial communication interfaces such as RS-485 and RS-232, as well as Modbus ASCII and Modbus TCP, which uses the Modbus RTU protocol embedded into TCP packets.

Modbus TCP is an internet protocol. The protocol embeds a Modbus frame into a TCP frame so that a connection-oriented approach is obtained, thereby making it more reliable. The master queries the slave and the slave responds with a reply. The protocol is open and, hence, highly scalable.

6.2 Modbus Message Structure

Modbus devices communicate using a master-slave (client-server) technique in which only one device (the master/client) can initiate transactions (called queries). The other devices (slaves/servers) respond by either supplying the requested data to the master or by taking the action requested in the query.

A query from a master will consist of a slave, or broadcast, address, a function code defining the requested action, any required data, and an error-checking field. A response from a slave consists of fields confirming the action taken, any data to be returned, and an error-checking field.

➤ The Modbus/TCP Message Structure

Bytes 00 - 05	Bytes 06 - 11
6-byte header	RTU Data

➤ The Leading 6 bytes of a Modbus/TCP Protocol Query

Byte 00	Byte 01	Byte 02	Byte 03	Byte 04	Byte 05
Transaction Identifier		Protocol Identifier		Length Field (upper byte)	Length Field (lower byte)

- ✓ **Transaction identifier** = Assigned by the Modbus/TCP master (client)
- ✓ **Protocol identifier** = 0
- ✓ **Length field (upper byte)** = 0 (since all messages are smaller than 256)
- ✓ **Length field (lower byte)** = The number of following RTU data bytes

➤ Modbus RTU Data Structure

Byte 06	Byte 07	Bytes 08 - 09	Bytes 10 - 11
Net ID (Station Number)	Function Code	Data Field	
		Reference Number (Address Mapping)	Number of Points

- ✓ **Net ID:** Specifies the address of the receiver (i.e., the Modbus/TCP slave).
- ✓ **Function Code:** Specifies the message type.
- ✓ **Data Field:** The data block.

Net ID (Station Number)

The first byte in the frame structure of a Modbus RTU query is the address of the receiver. A valid address is in the range of 0 to 247. Address 0 is used for general broadcast purposes, while addresses 1 to 247 are assigned to individual Modbus devices.

Function Code

The second byte in the message structure of a Modbus RTU query is the function code, which describes what the slave device is required to do. Valid function codes range between 1 and 255. To answer the query, the slave device uses the same function code as contained in the request. The highest bit of the function code will only be set to '1' if an error occurs in the system. In this way, the master device will know whether or not the message has been correctly transmitted.

Code	Function	Reference (Address)
01 (0x01)	Read the Status of the Coils (Read DO Readback values)	0xxxx
02 (0x02)	Read the Status of the Input (Read DI values)	1xxxx
03 (0x03)	Read the Holding Registers (Read AO Readback values)	4xxxx
04 (0x04)	Read the Input Registers (Read AI values)	3xxxx
05 (0x05)	Force a Single Coil (Write DO value)	0xxxx
06 (0x06)	Set a Single Register (Write AO value)	4xxxx
15 (0x0F)	Force Multiple Coils (Write DO values)	0xxxx
16 (0x10)	Set Multiple Registers (Write AO values)	4xxxx

Data Field

Data is transmitted in 8-, 16- and 32-bit formats. The data for 16-bit registers is transmitted in high-byte first format. For example, 0x0A0B will be transmitted as 0x0A, 0x0B. The data for 32-bit registers is transmitted as two 16-bit registers and is low-word first. For example: 0x0A0B0C0D will be transmitted as 0x0C, 0x0D, 0x0A, 0x0B.

The data field for messages sent between a master device and a slave device contains additional information about the action to be taken by the master, or any information requested by the slave. If the master does not require this information, the data field can be empty.

Reference (Address)	Description
0xxxx	<u>Read/Write Discrete Outputs or Coils.</u> An 0x reference address is used to output device data to a Digital Output channel.
1xxxx	<u>Read Discrete Inputs.</u> The ON/OFF status of a 1x reference address is controlled by the corresponding Digital Input channel.
3xxxx	<u>Read Input Registers.</u> A 3x reference register contains a 16-bit value received from an external source, e.g. an analog signal.
4xxxx	<u>Read/Write Outputs or Holding Registers.</u> A 4x register is used to store 16 bits of numerical data (binary or decimal), or to send data from the CPU to an output channel.



Note:

For more details regarding the address mapping, refer to [Section 6.3 \(DIO\)](#) or [Section 6.4 \(AIO\)](#) “Modbus Register Table”.

6.2.1 01(0x01) Read the Status of the Coils (Read DO Readback values)

This function code is used to read either the current status of the coils or the current Digital Output readback value from the ET-2200 series module.

[Request]

Byte	Description	Size	Value
00	Net ID (Station Number)	1 Byte	1 to 247
01	Function Code	1 Byte	0x01
02-03	Starting DO Address	2 Bytes	Refer to Section 6.3 or 6.4 "Modbus Register Table" to find the address. Byte 02 = high byte Byte 03 = low byte
04-05	Number of Points (Channels)	2 Bytes	Byte 04 = high byte Byte 05 = low byte

[Response]

Byte	Description	Size	Value
00	Net ID (Station Number)	1 Byte	1 to 247
01	Function Code	1 Byte	0x01
02	Byte Count	1 Byte	Byte Count of the Response ($n = (\text{Points}+7)/8$)
03	Data	n Bytes	n= 1; Byte 03 = data bit 7 to 0 n= 2; Byte 04 = data bit 15 to 8 n= m; Byte m+2 = data bit (8m-1) to 8(m-1)

[Error Response]

Byte	Description	Size	Value
00	Net ID (Station Number)	1 Byte	1 to 247
01	Function Code	1 Byte	0x81
02	Exception Code	1 Byte	Refer to the Modbus Standard Specifications for more details

Example: Function 01 (0x01), Readback DOs

➤ **Reads the Digital Output value**

	[Leading 6 bytes]	[Request]
Command:	<u>01 02 00 00 00 06</u>	<u>01 01 00 00 00 02</u>
	[Leading 6 bytes]	[Response]
Response:	<u>01 02 00 00 00 04</u>	<u>01 01 01 03</u>

➤ **A description of the command and response is as follows:**

Command:	[Leading 6 bytes]	
	Bytes 00-03	01 02 00 00 (Message Number)
	Bytes 04-05	00 06 (Number of bytes remaining in this frame)
	[Request]	
	Byte 00	01 (Net ID)
	Byte 01	01 (Function Code)
	Byte 02-03	00 00 (Starting DO Address)
	Byte 04-05	00 02 (Number of Points)

Response:	[Leading 6 bytes]	
	Bytes 00-03	01 02 00 00 (Message Number)
	Bytes 04-05	00 04 (Number of bytes remaining in this frame)
	[Response]	
	Byte 00	01 (Net ID)
	Byte 01	01 (Function Code)
	Byte 02	01 (Byte Count of the Response)
	Byte 03	03 (Value for DO0 to DO1)

6.2.2 02(0x02) Read the Status of the Input (Read DI values)

This function code is used to read the current Digital Input value from the ET-2200 series module.

[Request]

Byte	Description	Size	Value
00	Net ID (Station Number)	1 Byte	1 to 247
01	Function Code	1 Byte	0x02
02-03	Starting DI Address	2 Bytes	Refer to Section 6.3 or 6.4 "Modbus Register Table" to find the address. Byte 02 = high byte Byte 03 = low byte
04-05	Number of Points (Channels)	2 Bytes	Byte 04 = high byte Byte 05 = low byte

[Response]

Byte	Description	Size	Value
00	Net ID (Station Number)	1 Byte	1 to 247
01	Function Code	1 Byte	0x02
02	Byte Count	1 Byte	Byte Count of Response ($n = (\text{Points} + 7) / 8$)
03	Data	n Bytes	n= 1; Byte 03 = data bit 7 to 0 n= 2; Byte 04 = data bit 15 to 8 n= m; Byte m+2 = data bit(8m-1) to 8(m-1)

[Error Response]

Byte	Description	Size	Value
00	Net ID (Station Number)	1 Byte	1 to 247
01	Function Code	1 Byte	0x82
02	Exception Code	1 Byte	Refer to the Modbus Standard Specifications for more details

Example: Function 02 (0x02), ReadDIs➤ **Reads the Digital Input value**

Command:	[Leading 6 bytes] <u>01 02 00 00 00 06</u>	[Request] <u>01 02 00 00 00 02</u>
Response:	[Leading 6 bytes] <u>01 02 00 00 00 04</u>	[Response] <u>01 02 01 03</u>

➤ **A description of the command and response is as follows:**

Command:	[Leading 6 bytes]	
Bytes 00-03	01 02 00 00	(Message Number)
Bytes 04-05	00 06	(Number of bytes remaining in this frame)
	[Request]	
Byte 00	01	(Net ID)
Byte 01	02	(Function Code)
Byte 02-03	00 00	(Starting DI Address)
Byte 04-05	00 02	(Number of Points)

Response:	[Leading 6 bytes]	
Bytes 00-03	01 02 00 00	(Message Number)
Bytes 04-05	00 04	(Number of bytes remaining in this frame)
	[Response]	
Byte 00	01	(Net ID)
Byte 01	02	(Function Code)
Byte 02	01	(Byte Count of the Response)
Byte 03	03	(Value for DI0 to DI1)

6.2.3 03(0x03) Read the Holding Registers (Read AO Readback values)

This function code is used to read back either the current values in the holding registers or the Analog Output value from the ET-2200 series module. These registers are also used to store the preset values for the Digital Counter, the host watchdog timer, the module name, the TCP timeout, etc.

[Request]

Byte	Description	Size	Value
00	Net ID (Station Number)	1 Byte	1 to 247
01	Function Code	1 Byte	0x03
02-03	Starting AO Address	2 Bytes	Refer to Section 6.3 or 6.4 "Modbus Register Table" to find the address... Byte 02 = high byte ; Byte 03 = low byte
04-05	Number of 16-bit Registers (Channels)	2 Bytes	Word Count Byte 04 = high byte ; Byte 05 = low byte

[Response]

Byte	Description	Size	Value
00	Net ID (Station Number)	1 Byte	1 to 247
01	Function Code	1 Byte	0x03
02	Byte Count	1 Byte	Byte Count of the Response (n=Points x 2 Bytes)
03~	Register Values	n Bytes	Register Values n= 2; Byte 03 = high byte Byte 04 = low byte n= m; Byte m+1 = high byte Byte m+2 = low byte

[Error Response]

Byte	Description	Size	Value
00	Net ID (Station Number)	1 Byte	1 to 247
01	Function Code	1 Byte	0x83
02	Exception Code	1 Byte	Refer to the Modbus Standard Specifications for more details

Example: Function 03 (0x03), Read AOs

- Reads the name of the module for the ET-2260

	[Leading 6 bytes]	[Request]
Command:	<u>01 02 00 00 00 06</u>	<u>01 03 01 03 00 01</u>
	[Leading 6 bytes]	[Response]
Response:	<u>01 02 00 00 00 05</u>	<u>01 03 02 22 60</u>

- A description of the command and response is as follows:

Command:	[Leading 6 bytes]	
Bytes 00-03	01 02 00 00	(Message Number)
Bytes 04-05	00 06	(Number of bytes remaining in this frame)
	[Request]	
Byte 00	01	(Net ID)
Byte 01	03	(Function Code)
Byte 02-03	01 03	(Starting AO Address)
Byte 04-05	00 01	(Number of Points)

Response:	[Leading 6 bytes]	
Bytes 00-03	01 02 00 00	(Message Number)
Bytes 04-05	00 05	(Number of bytes remaining in this frame)
	[Response]	
Byte 00	01	(Net ID)
Byte 01	03	(Function Code)
Byte 02	02	(Byte Count of the Response)
Byte 03-04	22 60	(Module Name)

6.2.4 04(0x04) Read the Input Registers (Read AI values)

This function code is used to read either the input registers or the current analog input value from the ET-2200 series module. These registers are also used to store the current value for the digital counter, the number of DI channels and the number of DO channels, etc.

[Request]

Byte	Description	Size	Value
00	Net ID (Station Number)	1 Byte	1 to 247
01	Function Code	1 Byte	0x04
02-03	Starting AI Address	2 Bytes	Refer to Section 6.3 or 6.4 "Modbus Register Table" to find the address. Byte 02 = high byte Byte 03 = low byte
04-05	Number of 16-bit Registers (Channels)	2 Bytes	Word Count Byte 04 = high byte Byte 05 = low byte

[Response]

Byte	Description	Size	Value
00	Net ID (Station Number)	1 Byte	1 to 247
01	Function Code	1 Byte	0x04
02	Byte Count	1 Byte	Byte Count of the Response (n=Points x 2 Bytes)
03~	Register Values	n Bytes	Register Values n= 2; Byte 03 = high byte Byte 04 = low byte n= m; Byte m+1 = high byte Byte m+2 = low byte

[Error Response]

Byte	Description	Size	Value
00	Net ID (Station Number)	1 Byte	1 to 247
01	Function Code	1 Byte	0x84
02	Exception Code	1 Byte	Refer to the Modbus Standard Specifications for more details.

Example: Function 04 (0x04), Read AIs

- Reads the number of the DI channels on the ET-2260

	[Leading 6 bytes]	[Request]
Command:	<u>01 02 00 00 00 06</u>	<u>01 04 00 64 00 01</u>
	[Leading 6 bytes]	[Response]
Response:	<u>01 02 00 00 00 05</u>	<u>01 04 02 00 02</u>

- A description of the command and response is as follows:

Command:	[Leading 6 bytes]	
Bytes 00-03	01 02 00 00	(Message Number)
Bytes 04-05	00 06	(Number of bytes remaining in this frame)
	[Request]	
Byte 00	01	(Net ID)
Byte 01	04	(Function Code)
Byte 02-03	0064	(Starting AI Address)
Byte 04-05	00 01	(Number of 16-bit Registers)

Response:	[Leading 6 bytes]	
Bytes 00-03	01 02 00 00	(Message Number)
Bytes 04-05	00 05	(Number of bytes remaining in this frame)
	[Response]	
Byte 00	01	(Net ID)
Byte 01	04	(Function Code)
Byte 02	02	(Byte Count of the Response)
Byte 03-04	00 02	(Number of DI channels on the ET-2260)

6.2.5 05(0x05) Force a Single Coil (Write DO value)

This function code is used to set the status of a single coil or a single Digital Output value for the ET-2200 series module.

[Request]

Byte	Description	Size	Value
00	Net ID (Station Number)	1 Byte	1 to 247
01	Function Code	1 Byte	0x05
02-03	DO Address	2 Bytes	Refer to Section 6.3 or 6.4 "Modbus Register Table" to find the address. Byte 02 = high byte ; Byte 03 = low byte
04-05	Output Value	2 Bytes	0xFF 00 sets the output to ON. 0x00 00 sets the output to OFF. All other values are invalid and will not affect the coil. Byte 04 = high byte ; Byte 05 = low byte

[Response]

Byte	Description	Size	Value
00	Net ID (Station Number)	1 Byte	1 to 247
01	Function Code	1 Byte	0x05
02-03	DO Address	2 Bytes	The value is the same as Bytes 02-03 of the Request
04-05	Output Value	2 Bytes	The value is the same as Bytes 04-05 of the Request

[Error Response]

Byte	Description	Size	Value
00	Net ID (Station Number)	1 Byte	1 to 247
01	Function Code	1 Byte	0x85
02	Exception Code	1 Byte	Refer to the Modbus Standard Specifications for more details.

Example: Function 05 (0x05), Write DO

➤ Sets channel DO1 to ON

Command:	[Leading 6 bytes] <u>01 02 00 00 00 06</u>	[Request] <u>01 05 00 01 FF 00</u>
Response:	[Leading 6 bytes] <u>01 02 00 00 00 06</u>	[Response] <u>01 05 00 01 FF 00</u>

➤ A description of the command and response is as follows:

Command:	[Leading 6 bytes]	
Bytes 00-03	01 02 00 00	(Message Number)
Bytes 04-05	00 06	(Number of bytes remaining in this frame)
	[Request]	
Byte 00	01	(Net ID)
Byte 01	05	(Function Code)
Byte 02-03	0001	(DO Address)
Byte 04-05	FF 00	(Sets the output to ON)

Response:	[Leading 6 bytes]	
Bytes 00-03	01 02 00 00	(Message Number)
Bytes 04-05	00 06	(Number of bytes remaining in this frame)
	[Response]	
Byte 00	01	(Net ID)
Byte 01	05	(Function Code)
Byte 02-03	00 01	(DO Address)
Byte 04-05	FF 00	(Indicates that the DO has been set to ON)

6.2.6 06(0x06) Set a Single Register (Write AO value)

This function code is used to set a specific holding register to store the configuration values for the ET-2200 series module.

[Request]

Byte	Description	Size	Value
00	Net ID (Station Number)	1 Byte	1 to 247
01	Function Code	1 Byte	0x06
02-03	AO Address	2 Bytes	Refer to Section 6.3 or 6.4 "Modbus Register Table" to find the address. Byte 02 = high byte Byte 03 = low byte
04-05	Register Value	2 Bytes	Register Value Byte 04 = high byte Byte 05 = low byte

[Response]

Byte	Description	Size	Value
00	Net ID (Station Number)	1 Byte	1 to 247
01	Function Code	1 Byte	0x06
02-03	AO Address	2 Bytes	The value is the same as Bytes 02-03 of the Request
04-05	Register Value	2 Bytes	The value is the same as Bytes 04-05 of the Request

[Error Response]

Byte	Description	Size	Value
00	Net ID (Station Number)	1 Byte	1 to 247
01	Function Code	1 Byte	0x86
02	Exception Code	1 Byte	Refer to the Modbus Standard Specifications for more details.

Example: Function 06 (0x06), WriteAO

- Sets the system timeout to 60 seconds

	[Leading 6 bytes]	[Request]
Command:	<u>01 02 00 00 00 06</u>	<u>01 06 01 08 00 3C</u>
	[Leading 6 bytes]	[Response]
Response:	<u>01 02 00 00 00 06</u>	<u>01 06 01 08 00 3C</u>

- A description of the command and response is as follows:

Command:	[Leading 6 bytes]	
Bytes 00-03	01 02 00 00	(Message Number)
Bytes 04-05	00 06	(Number of bytes remaining in this frame)
	[Request]	
Byte 00	01	(Net ID)
Byte 01	06	(Function Code)
Byte 02-03	0108	(AO Address)
Byte 04-05	003C	(Sets the system timeout to 60 seconds)

Response:	[Leading 6 bytes]	
Bytes 00-03	01 02 00 00	(Message Number)
Bytes 04-05	00 06	(Number of bytes remaining in this frame)
	[Response]	
Byte 00	01	(Net ID)
Byte 01	06	(Function Code)
Byte 02-03	01 08	(AO Address)
Byte 04-05	003C	(Indicates that the system timeout has been set to 60 seconds)

6.2.7 15(0x0F) Force Multiple Coils (Write DO values)

This function code is used to set the status of multiple coils or to write multiple Digital Output values for the ET-2200 series module.

[Request]

Byte	Description	Size	Value
00	Net ID (Station Number)	1 Byte	1 to 247
01	Function Code	1 Byte	0x0F
02-03	Starting DO Address	2 Bytes	Refer to Section 6.3 or 6.4 “Modbus Register Table” to find the address. Byte 02 = high byte ; Byte 03 = low byte
04-05	Number of Output Channels (Points)	2 Bytes	Byte 04 = high byte ; Byte 05 = low byte
06	Byte count	1 Byte	$n = (\text{Points} + 7) / 8$
07	Output value	n Bytes	A bit corresponds to a channel. A value of 1 for a bit denotes that the channel is ON, while a value of denotes that the channel is OFF. n= 1; Byte 07 = data bit 7 to 0 n= 2; Byte 08 = data bit 15 to 8 n= m; Byte m+6 = data bit (8m-1) to 8 (m-1)

[Response]

Byte	Description	Size	Value
00	Net ID (Station Number)	1 Byte	1 to 247
01	Function Code	1 Byte	0x0F
02-03	Starting DO Address	2 Bytes	The value is the same as Bytes 02-05 of the Request
04-05	Number of Output Channels (Points)	2 Bytes	

[Error Response]

Byte	Description	Size	Value
00	Net ID (Station Number)	1 Byte	1to 247
01	Function Code	1 Byte	0x8F
02	Exception Code	1 Byte	Refer to the Modbus Standard Specifications for more details.

Example: Function 15 (0x0F), Write DOs

➤ Sets the safe value (DO0 ~ DO1)

Command:	[Leading 6 bytes] <u>01 02 00 00 00 08</u>	[Request] <u>01 0F 01 0B 00 02 01 03</u>
Response:	[Leading 6 bytes] <u>01 02 00 00 00 06</u>	[Response] <u>01 0F 01 0B 00 02</u>

➤ A description of the command and response is as follows:

Command:	[Leading 6 bytes]	
Bytes 00-03	01 02 00 00	(Message Number)
Bytes 04-05	00 08	(Number of bytes remaining in this frame)
	[Request]	
Byte 00	01	(Net ID)
Byte 01	0F	(Function Code)
Byte 02-03	010B	(Starting DO Address)
Byte 04-05	0002	(Number of Output Channels)
Byte 06	01	(Byte Count)
Byte 07	03	(Output Value)

Response:	[Leading 6 bytes]	
Bytes 00-03	01 02 00 00	(Message Number)
Bytes 04-05	00 06	(Number of bytes remaining in this frame)
	[Response]	
Byte 00	01	(Net ID)
Byte 01	0F	(Function Code)
Byte 02-03	01 0B	(Starting DO Address)
Byte 04-05	00 02	(Number of Input Channels)

6.2.8 16(0x10) Set Multiple Registers (Write AO values)

This function code is used to set multiple holding registers that are used to store the configuration values for the ET-2200 series module.

[Request]

Byte	Description	Size	Value
00	Net ID (Station Number)	1 Byte	1 to 247
01	Function Code	1 Byte	0x10
02-03	Starting AO Address	2 Bytes	Refer to Section 6.3 or 6.4 “Modbus Register Table” to find the address. Byte 02 = high byte ; Byte 03 = low byte
04-05	Number of 16-bit Registers (Channels)	2 Bytes	Word Count. Byte 04 = high byte ; Byte 05 = low byte
06	Byte Count	1 Byte	n = Points x 2 Bytes
07	Register Values	n Bytes	Register Values. n= 2; Byte 03 = high byte Byte 04 = low byte n= m; Byte m+1 = high byte Byte m+2 = low byte

[Response]

Byte	Description	Size	Value
00	Net ID (Station Number)	1 Byte	1 to 247
01	Function Code	1 Byte	0x10
02-03	Starting AO Address	2 Bytes	The value is the same as Bytes 02-03 of the Request
04-05	Number of 16-bit Registers (Channels)	2 Bytes	The value is the same as Bytes 04-05 of the Request

[Error Response]

Byte	Description	Size	Value
00	Net ID (Station Number)	1 Byte	1 to 247
01	Function Code	1 Byte	0x90
02	Exception Code	1 Byte	Refer to the Modbus Standard Specifications for more details.

Example: Function 16 (0x10), WriteAOs

➤ Sets the preset value for the digital counter

Command:	[Leading 6 bytes] <u>01 02 00 00 00 0B</u>	[Request] <u>01 10 00 32 0 001 02 03 E8 00 00</u>
Response:	[Leading 6 bytes] <u>01 02 00 00 00 06</u>	[Response] <u>01 10 00 32 00 01</u>

➤ A description of the command and response is as follows:

Command:	[Leading 6 bytes]	
Bytes 00-03	01 02 00 00	(Message Number)
Bytes 04-05	00 0B	(Number of bytes remaining in this frame)
	[Request]	
Byte 00	01	(Net ID)
Byte 01	10	(Function Code)
Byte 02-03	0032	(Starting AO Address)
Byte 04-05	0001	(Number of 16-bit Registers)
Byte 06	02	(Byte Count)
Byte 07-10	03 E8 00 00	(Preset value for the digital counter)

Response:	[Leading 6 bytes]	
Bytes 00-03	01 02 00 00	(Message Number)
Bytes 04-05	00 06	(Number of bytes remaining in this frame)
	[Response]	
Byte 00	01	(Net ID)
Byte 01	10	(Function Code)
Byte 02-03	0032	(Starting AO Address)
Byte 04-05	00 01	(word count)

6.3 Modbus Register Table (For DIO Module)

Data from 16-bit registers is transmitted in high-byte first order. For example: 0x0A0B ==> 0x0A, 0x0B.
Data from 32-bit registers is transmitted as two 16-bit registers and is in low-word first order. For example: 0x0A0B0C0D ==> 0x0C, 0x0D, 0x0A, 0x0B.

6.3.1 Common Functions

➤ 0xxxx: DO Address (Base 0)

Starting Address	Points	Description	Bits per Point	Range	Access Type
127 (0x7F)	1	Restores all default web settings	1	1 = Restore	W (Pulse)
128 (0x80)	1	Default ID Settings	1	1 = Restore	W (Pulse)
133 (0x85)	1	Reboots the ET-2200 module	1	1 = Reboot	W (Pulse)
Notes	"W": Write				

➤ 3xxxx: AI Address (Base 0)

Starting Address	Points	Description	Bits per Point	Range	Access Type
151 (0x97)	1	Firmware Version	16	"123" denotes that the version is 1.2.3	R
158 (0x9E)	1	Modbus Communication Status	16	0 = No Error 1 = Timeout	R
160 (0xA0)	1	Pair-Connection Status	16	0 = Normal 1 = Timeout 2 = Disconnected	R
Notes	"R": Read				

➤ **4xxx: AO Address (Base 0)**

Starting Address	Points	Description	Bits per Point	Range	Access Type
255 (0xFF)	1	CPU Reset Status	16	1 = Reset at Power-on 2 = Reset by the WDT 3 = Reset using the reset command	R/W
257 (0x101)	1	Sets the Host Watchdog Timer (WDT)	16	<5: Disabled 5 to 65535: Enabled (units: seconds) 0: Default If the ET-2200 series module loses communication with the host PC for more than the period defined in the WDT settings, the DO channels will revert to their safe values and the Host WDT Events Counter will be increased by one.	R/W/F
258 (0x102)	1	Host WDT Events	16	Denotes how many Host WDT Events have occurred since the last CPU reset	R/W
259 (0x103)	1	Module Name	16	Module Name	R
263 (0x107)	1	Sets the TCP Timeout Value	16	<5: Disabled 5 to 65535: Enabled (units: seconds) 0: Default	R/W/F
264 (0x108)	1	Sets the System Timeout Value	16	<30: Disabled 30~65535: Enabled (unit: second) 0: Default	R/W/F
Notes	<p>“R”: Read; “W”: Write; “F”: Setting is recorded in flash as default. Warning: Frequent writing to the Flash can cause it to become corrupt.</p>				

6.3.2 Specific Functions

The nDI and nDO parameters for each ET-2200 series module used in the following Modbus Address Tables are as follows:

Model Name	Universal DIO (UDIO)	Number of DO channels (nDO)	Number of DI channels (nDI)
ET-2242/ET-2242U	-	16	-
ET-2251	-	-	16
ET-2254/ET-2254P	16	Depend on your configuration	Depend on your configuration
ET-2255/ET-2255U	-	8	8
ET-2260	-	6	6
ET-2261	-	10	-
ET-2261-16	-	16	-
ET-2268	-	8	-

➤ 0xxxx: DO Address (Base 0)

Starting Address	Points	Description	Bits per Point	Range	Access Type
0 (0x00)	1 to nDO	Digital Output Channels	1	0 = Off 1 = On	R/W
32 (0x20)	1	Clears the status of all high-latched DI Channels	1	1 = Clear	W
33 (0x21)	1	Clears the status of all low-latched DI Channels	1	1 = Clear	W
34 (0x22)	1 to nDI	Clears the high-speed digital counter for all DI Channels	1	1 = Clear	W
60 (0x3C)	1	Saves specific data to Flash (The access type for some registers labeled with an "E")	1	0: cannot write 1: can be write	W
100 (0x64)	1 to nDO	Enables the PWM for all DO Channels	1	0 = Off 1 = On (Default= 0)	R/W
150 (0x96)	1	Enables the high and low latches for all DI Channels	1	0 = Disable 1 = Enable (Default= 0)	R/W/F

Starting Address	Points	Description	Bits per Point	Range	Access Type
151 (0x97)	1 to nDI	Enables the high-speed digital counter for all DI Channels	1	0 = Disable 1 = Enable (Default= 0)	R/W/F
190 (0xBE)	1 to nDI	Enables frequency measurement for all DI Channels	1	0 = Disable 1 = Enable (Default= 0)	R/W/F
235 (0xEB)	1 to nDO	Sets the Power-on value for all DO Channels	1	0 = Off 1 = On (Default= 0)	R/W/F
267 (0x10B)	1 to nDO	Sets the Safe value for all DO Channels	1	0 = Off 1 = On (Default= 0)	R/W/F
299 (0x12B)	1	Force the DI/DO Mode. (for the ET-2254 only) 0 = Dynamic I/O type based on DO requests. 1 = Static I/O type by configuration (web or Modbus).	1	0 = Dynamic 1= Static	R/W
300 ~ 315 (0x12C ~ 0x13B)	1 to UDIO	Sets the Universal DIO channels to DI or DO Port. (for the ET-2254 only) 300 is the CH0 address, 301 is the CH1 address, and so on.	1	0 = DO type 1= DI type	R/W
Notes	<p>“R”: Read “W”: Write “F”: Settings are recorded in flash by default “E”: After writing DO[60] register, the data will be stored in flash. Warning: Frequency writing to the Flash can cause it to become corrupt.</p>				

**Note:**

Because of the characteristics of the relay functions, it is recommended that the PWM on ET-2260/2261/2268 series (i.e., modules with relay functions) is not used for extended periods.

➤ **1xxx: DI Address (Base 0)**

Starting Address	Points	Description	Bits per Point	Range	Access Type
0 (0x00)	1 to nDI	The status of all Digital Input Channels	1	0 = Off 1 = On	R
32 (0x20)	1 to nDI	The status of all high-latched DI Channels	1	0 = None 1 = Latched	R
64 (0x40)	1 to nDI	The status of all low-latched DI Channels	1	0 = None 1 = Latched	R
Notes	"R": Read				

➤ **3xxx: AI Address (Base 0)**

Starting Address	Points	Description	Bits per Point	Value	Access Type
16 (0x10)	1 to nDI	The Digital Counter Value	32	0 to 4294967296	R
64 (0x40)	1 to nDI	The frequency Value is * 1,000. (Note: The Client must first divide the value by 1,000.)	32	0 to 4294967296	R

Note: 

The "DI Counter (0x10)" and "DI Frequency (0x40)" record data as a 32-bit value and are transmitted as two 16-bit registers. Consequently, the register's address has an offset of 2, i.e., the address of the second channel will be at the starting address +2, and so on. You can refer to "[FAQ_How do I read DI Counter for the PETL/t\(P\)ET/ET-2200 Series Modules correctly](#)" for more detailed information.

Example: Reads the 6 DI Counter on the ET-2260.

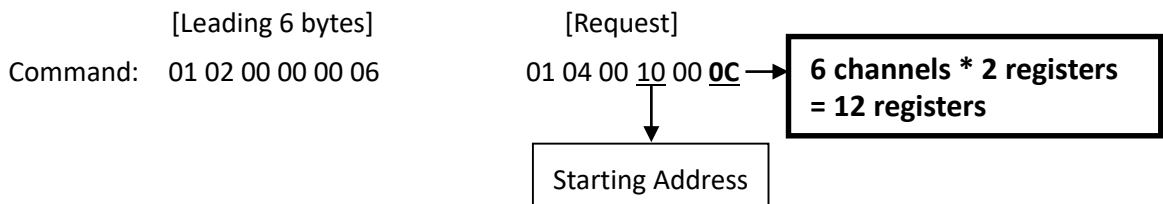

100 (0x64)	1	Number of DI Channels	16	nDI	R
110 (0x6E)	1	Number of DO Channels	16	nDO	R
121 (0x79)	1	Number of high-speed counters	16	nDI	R
Notes	"R": Read				

➤ **4xxx: AO Address (Base 0)**

Starting Address	Points	Description	Bits per Point	Range	Access Type
50 (0x32)	1 to nDI	The preset value for the high-speed digital counter	32	0 to 4294967296	R/W/E
<p> Note: “Preset DI Counter Value (0x32)” that the records data as a 32-bit value and is transmitted as two 16-bit registers. Consequently, the register’s address has an offset of 2, i.e., the address of the second channel will be at the starting address +2, and so on. You can refer to “FAQ_How do I read DI Counter for the t(P)ET/ET-2200 Series Modules correctly” for more detailed information.</p> <p>Example: Reads the preset value of 6DI Counter on the ET-2260.</p> <div style="display: flex; align-items: center; justify-content: center;"> <div style="text-align: center;"> <p>[Leading 6 bytes]</p> <p>Command: 01 02 00 00 00 06</p> </div> <div style="margin: 0 20px;"> <p>[Request]</p> <p>01 04 00 <u>32</u> 00 <u>0C</u></p> </div> <div style="border: 1px solid black; padding: 5px; text-align: center;"> <p>6 channels * 2 registers = 12 registers</p> </div> </div> <div style="text-align: center; margin-top: 10px;"> <p>↓</p> <div style="border: 1px solid black; padding: 5px; display: inline-block;">Starting Address</div> </div>					
100 (0x64)	1 to nDO	The duty cycle for the DO PWM The first word (16-bit register) is the high pulse width, while the second word is the low pulse width. The units rein ms and the resolution is about 10 ms.	32	0 to 65535; 0 to 65535;	R/W/E
150 (0x64)	1 to nDO	The Scan mode for the DI frequency measurement. Refer to Section 4.4.2 “DI/DO Configuration” for more details.	16	1000= 1000ms 100= 100ms 2000=Single pulse	R/W/F
200 (0x64)	1 to nDI	The moving average of the DI frequency measurement.	16	1= No average 2=Average 2 values 4=Average 4 values 8=Average 8 values	R/W/F
268 (0x10C)	1 to nDO	The Min-Switching Time for all DO Channels	16	1 to 65535 second	R/W/F
284 (0x11C)	1 to nDO	The Auto-off Time for all DO Channels	16	1 to 65535 second	R/W/F
Notes	<p>“R”: Read “W”: Write “F”: Settings are recorded in flash by default “E”: After writing the DO[60] register, the data will be stored in flash. Warning: Frequent writing to the Flash can cause it to become corrupt.</p>				

6.4 Modbus Register Table (For AIO Module)

6.4.1 Modbus Register Table for (P)ET-2217

Coils (0xxxx)

Register		Points	Description	Data Format	Attribute	Factory Value
DEC	HEX					
00162: 00169	00A2: 00A9	8	Clear 1-ch historical AI max. value	1: Clear	W	-
00194: 00201	00C2: 00C9	8	Clear 1-ch historical AI min. value	1: Clear	W	-
00226	00E2	1	Reset the I/O settings to the factory default state	1: Reset	W	-
00233	00E9	1	Reboot the module	1: Reboot	W	-
00435: 00438	01B3: 01B6	4	Enable/Disable the DO power-on value function	0: Disable 1: Enable	R/W	0
00515: 00518	0203: 0206	4	Enable/Disable the DO safe value function	0: Disable 1: Enable	R/W	0
00595: 00602	0253: 025A	8	Enable/Disable the AI function	0: Disable 1: Enable	R/W/E	1
00628	0274	1	Set the AI sampling rate	0: Normal mode (20 Hz) 1: Fast mode (200 Hz)	R/W/E	0
00631	0277	1	Set the AI data format	0: Hexadecimal format 1: Engineering unit	R/W/E	0
00632	0278	1	Reset the AI calibration to the factory settings	1: Reset	W	-
00634	027A	1	Clear all historical AI max. values	1: Clear	W	-
00635	027B	1	Clear all historical AI min. values	1: Clear	W	-
00636: 00643	027C: 0283	8	Enable/Disable the AI high alarm function	0: Disable 1: Enable	R/W/E	0

Register		Points	Description	Data Format	Attribute	Factory Value
DEC	HEX					
00668: 00675	029C: 02A3	8	Enable/Disable the AI low alarm function	0: Disable 1: Enable	R/W/E	0
00700: 00707	02BC: 02C3	8	Set the AI high alarm mode	0: Momentary mode 1: Latching mode	R/W/E	0
00732: 00739	02DC: 02E3	8	Set the AI low alarm mode	0: Momentary mode 1: Latching mode	R/W/E	0
00764: 00771	02FC: 0303	8	Clear the AI high alarm status	1: Clear	W	-
00796: 00803	031C: 0323	8	Clear the AI low alarm status	1: Clear	W	-
00830	033E	1	Enable/Disable the AI calibration	0: Disable 1: Enable	R/W	-
00831	033F	1	Zero calibration for channel 0	1: Set	W	-
00832	0340	1	Span/Gain calibration for the channel 0 ~ 7	1: Set	W	-

Discrete Inputs (1xxxx)

Register		Points	Description	Data Format	Attribute
DEC	HEX				
10224: 10231	00E0: 00E7	8	Read AI high alarm status. When the AI value is higher than the high alarm value, the status becomes 1.	0: Normal 1: Alarmed	R
10256: 10263	0100: 0107	8	Read AI low alarm status. When the AI value is lower than the low alarm value, the status becomes 1.	0: Normal 1: Alarmed	R

Input Register (3xxxx)

Register		Points	No. Per Point	Description	Data Format	Attribute
DEC	HEX					
30000: 30007	0000: 0007	8	1	AI value	-32768 to 32767 (0x0000 to 0xFFFF)	R
30236: 30243	00EC: 00F3	8	1	AI historical max. value	-32768 to 32767 (0x0000 to 0xFFFF)	R
30268: 30275	010C: 0113	8	1	AI historical min. value	-32768 to 32767 (0x0000 to 0xFFFF)	R
30320	0140	1	1	Number of the AI channel	8	R
30351	015F	1	1	Firmware version	0x123 means version 1.2.3	R
30360	0168	1	1	Communication state of the pair-connection	0: Normal < 0: Failed	R

Holding Register (4xxxx)

Register		Points	No. Per Point	Description	Data Format	Attribute	Factory Value
DEC	HEX						
40271	010F	1	1	Set the module identification (Modbus NetID)	0 to 255	R/W/E	1
40296: 40303	0128: 012F	8	1	Set the AI high alarm value	-32768 to 32767 (0x0000 to 0xFFFF)	R/W/E	32767 (0x7FFF)
40328: 40335	0148: 014F	8	1	Set the AI low alarm value	-32768 to 32767 (0x0000 to 0xFFFF)	R/W/E	-32768 (0x8000)
40427: 40434	01AB: 01B2	8	1	Set the AI range	0x07: 4 ~ 20 mA 0x08: +/-10 V 0x09: +/-5 V 0x0A: +/-1 V 0x0B: +/-500 mV 0x0C: +/-150 mV 0x0D: +/-20 mA 0x1A: 0 ~ 20 mA	R/W/E	0x08

Register		Points	No. Per Point	Description	Data Format	Attribute	Factory Value
DEC	HEX						
40555	022B	1	1	Read the module reset status	1: Power-on 2: Module Watchdog 3: Software Reset Command	R	-
40556	022C	1	1	Read the boot count of the module. The factory default value is 0 when the settings are set to the factory default values.	1 to 32767	R	-
40559	022F	1	1	Read the module name	0x2217	R	-

6.4.2 Modbus Register Table for ET-2217CI

➤ 3xxxx: AI Address / 4xxxx: AO Address (Base 0)

Address	Description	Attribute
30000 ~ 30007 40000 ~ 40007	Analog input values of channels 0 to 7	R
30100 40100	Number of the digital input channels	R
30110 40110	Number of the digital output channels	R
30120 40120	Number of the analog input channels	R
30130 40130	Number of the analog output channels	R
30151 40151	Firmware version	R
30180 ~ 30194 40180 ~ 40194	Alias name	R
40212 ~ 40219	Type codes of analog input channels 0 to 7	R/W
40257	Ethernet host watchdog timeout value, 5 to 65535, in second, 0 to disable.	R/W
30258 40258	Ethernet host watchdog timeout count.	R
30259 ~ 30260 40259 ~ 40260	Module name.	R
40263	TCP disconnection timeout value, 5 to 65535, in second, 0 to disable.	R/W
40264	Module reset timeout value, 30 to 65535, in second, 0 to disable. Only for Modbus TCP protocol	R/W
30512 ~ 30519 40512 ~ 40519	High latched analog input value of channel 0 to 7	R
30544 ~ 30551 40544 ~ 40551	Low latched analog input value of channel 0 to 7	R

Address	Description	Attribute
40864	RTC year, 2000 to 2159	R/W
40865	RTC month, 1 to 12	R/W
40866	RTC date, 1 to 31	R/W
40867	RTC hour, 0 to 23	R/W
40868	RTC minute, 0 to 59	R/W
40869	RTC second, 0 to 59	R/W
40870 ~ 40871	The index of the last log record	R
40872 ~ 40873	The index of the log record to be read	R/W
40874	The status of the data logging, 0: stopped, 1: running	R
40875	The data logger command, 0: stop, 1: run in continuous mode, 2: run in a period mode	R/W
40876	Continue writing when the data logger is full, 0: no, 1: yes	R/W
40878	Data logger sampling period in seconds	R/W
40879	Data logger sampling period in milliseconds, 0 ~ 1000. It should be a multiple of 5.	R/W
40880	Starting year when logging in period mode, 2000 ~ 2159	R/W
40881	Starting month when logging in period mode, 1 to 12	R/W
40882	Starting date when logging in period mode, 1 to 31	R/W
40883	Starting hour when logging in period mode, 0 to 23	R/W
40884	Starting minute when logging in period mode, 0 to 59	R/W
40885	Starting second when logging in period mode, 0 to 59	R/W
40886	Ending year when logging in period mode, 2000 to 2159	R/W
40887	Ending month when logging in period mode, 1 to 12	R/W
40888	Ending date when logging in period mode, 1 to 31	R/W
40889	Ending hour when logging in period mode, 0 to 23	R/W
40890	Ending minute when logging in period mode, 0 to 59	R/W
40891	Ending second when logging in period mode, 0 to 59	R/W
40898 ~ 40899	The index of the first log record	R

Address	Description	Attribute
34097 ~ 34206 44097 ~ 44206	Read log data and it should be multiple of 11 registers. For every 11 registers, they are a value of channel 0, ..., the value of channel 7, time stamp low word, time stamp high word, and millisecond time stamp. The timestamp is in Epoch time format.	R
00096 ~ 00103 10096 ~ 10103	Under range status of channel 0 to 7 for 0mA to 20mA and 4mA to 20mA ranges	R
00127	Write 1 to reload the default settings	W
00128	Write 1 to set Modbus TCP ID to 1	W
00133	Write 1 to reboot the module	W
00140	Data format, 0: hex, 1: engineering	R/W
00141	Sampling rates, 0: 10Hz, 1: 200Hz	R/W
00142	Write 1 to reload factory calibration parameters	W

6.4.3 Modbus Register Table for (P)ET-2224/2228

Coils (0xxxx)

Register		Points	Description	Data Format	Attribute	Factory Value
DEC	HEX					
00226	00E2	1	Reset the I/O settings to the factory default state	1: Reset	W	-
00233	00E9	1	Reboot the module	1: Reboot	W	-
00631	0277	1	Set the AO data format	0: Hexadecimal format 1: Engineering unit	R/W/E	0
00632	0278	1	Reset the AO calibration to the factory settings	1: Reset	W	-

Discrete Inputs (1xxxx)

Register		Points	Description	Data Format	Attribute
DEC	HEX				
10290: 10297	0122: 0129	4/8	Read the Current mode wire break status.	0: Normal 1: Wire Break	R

Input Register (3xxxx)

Register		Points	No. Per Point	Description	Data Format	Attribute
DEC	HEX					
30330	014A	1	1	Number of the AO channel	8	R
30351	015F	1	1	Firmware version	0x123 means version 1.2.3	R
30360	0168	1	1	Communication state of the pair-connection	0: Normal <0: Failed	R

Holding Register (4xxxx)

Register		Points	No. Per Point	Description	Data Format	Attribute	Factory Value
DEC	HEX						
40000: 40007	0000: 0007	4/8	1	AO value	-32768 to 32767 (0x0000 to 0xFFFF)	R/W	-
40271	010F	1	1	Set the module identification (Modbus NetID)	0 to 255	R/W/E	1
40360: 40367	0168: 016F	4/8	1	Set the power-on value for the AO channel	-32768 to 32767 (0x0000 to 0xFFFF)	R/W/E	0
40392: 40399	0188: 018F	4/8	1	Set the safe value for the AO channel	-32768 to 32767 (0x0000 to 0xFFFF)	R/W/E	0
40459: 40466	01CB: 01D2	4/8	1	Set the AO range	0x30: 0~20 mA 0x31: 4~20 mA 0x32: 0~10 V 0x33: +/-10 V 0x34: 0~5 V 0x35: +/-5 V	R/W/E	0x32

Register		Points	No. Per Point	Description	Data Format	Attribute	Factory Value
DEC	HEX						
40523: 40530	020B: 0212	4/8	1	Set the AO slew rate range	0x00: Immediate 0x01: 0.0625 V/sec or 0.125 mA/sec 0x02: 0.125 V/sec or 0.25 mA/sec 0x03: 0.25 V/sec or 0.5 mA/sec 0x04: 0.5 V/sec or 1.0 mA/sec 0x05: 1.0 V/sec or 2.0 mA/sec 0x06: 2.0 V/sec or 4.0 mA/sec 0x07: 4.0 V/sec or 8.0 mA/sec 0x08: 8.0 V/sec or 16 mA/sec 0x09: 16 V/sec or 32 mA/sec 0x10: 32 V/sec or 64 mA/sec 0x11: 64 V/sec or 128 mA/sec 0x12: 128 V/sec or 256 mA/sec 0x13: 256 V/sec or 512 mA/sec 0x14: 512 V/sec or 1024 mA/sec	R/W/E	0x00

Register		Points	No. Per Point	Description	Data Format	Attribute	Factory Value
DEC	HEX						
40555	022B	1	1	Read the module reset status	1: Power-on 2: Module Watchdog 3: Software Reset Command	R	-
40556	022C	1	1	Read the boot count of the module. The factory default value is 0 when the settings are set to the factory default values.	1 to 32767	R	-
40557	022D	1	1	Set the Host WDT timeout (unit: second)	0: Disable the Host WDT 6 to 65535: Enable the Host WDT	R/W/E	0
40558	022E	1	1	Read the WDT event count. The initial value is 0 when the module is reset and is increased when the WDT event happens.	0 to 32767	R	-
40559	022F	1	1	Read the module name	0x2224/0x2228	R	-

6.5 Analog Input Type and Data Format Table

Type Code	Input Type	Data Format	Max.	Min.
05	-2.5 to +2.5 V	Engineering unit	+25000	-25000
		2's comp HEX	7FFF	8000
06	-20 to +20 mA	Engineering unit	+20000	-20000
		2's comp HEX	7FFF	8000
07	+4 to +20 mA	Engineering unit	+20000	+4000
		2's comp HEX	FFFF	0000
08	-10 to +10 V	Engineering unit	+10000	-10000
		2's comp HEX	7FFF	8000
09	-5 to +5 V	Engineering unit	+5000	-5000
		2's comp HEX	7FFF	8000
0A	-1 to +1 V	Engineering unit	+10000	-10000
		2's comp HEX	7FFF	8000
0D	-20 to +20 mA	Engineering unit	+20000	-20000
		2's comp HEX	7FFF	8000
1A	0 to +20 mA	Engineering unit	+20000	0
		2's comp HEX	FFFF	0000

Appendix A: Troubleshooting

A.1 How do I restore the web password for the module to the factory defaults?

The instructions below outline the procedure for resetting the web password to the factory default value.

 **Note:** Be aware that all settings will be restored to the factory default values after the module is reset.

Step 1

Locate the Init/Run switch that can be found on the top side of the ET-2200 module and set it to the "Init" position. Reboot the module to **load the factory default settings** including the default web password.

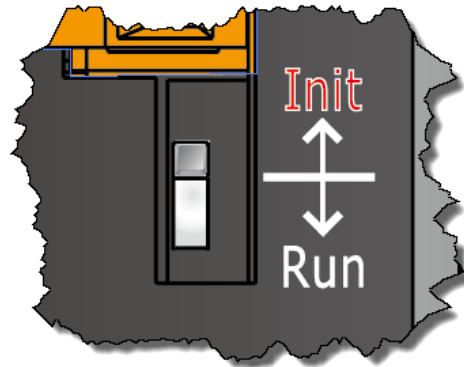

Step 2

Execute either the eSearch Utility or the VxComm Utility to search for any ET-2200 modules connected to the network. Verify that the ET-2200 has been reset to the original factory default settings. The default IP address is 192.168.255.1.

Name	Alias	IP Address	Sub-net Mask	Gateway	MAC Address
iDS-720	UA-Serie...	192.168.85.23	255.255.0.0	192.168.1.1	90:70:65:40:A0:C7
ET-2260	EtherIO	192.168.255.1	255.255.0.0	192.168.0.1	00:0d:e0:65:e9:85
ET-2260	#2	192.168.79.100	255.255.0.0	192.168.1.1	00:0d:e0:65:cf:d3
DL-302	EtherIO	192.168.84.62	255.255.0.0	192.168.0.1	00:0d:e0:92:06:69
DL-302	EtherIO	192.168.101.15	255.255.0.0	192.168.1.1	00:0D:E0:92:00:A1
ET-7255/PET-7255	Slave	192.168.79.55	255.255.0.0	192.168.1.1	00:0d:e0:65:ed:d1

Step 3

Double-click the name of the module to open the Configure Server (UDP) dialog box, modify the basic settings as necessary, e.g., the IP, Mask, and Gateway addresses, and then click the "OK" button to save the new settings.

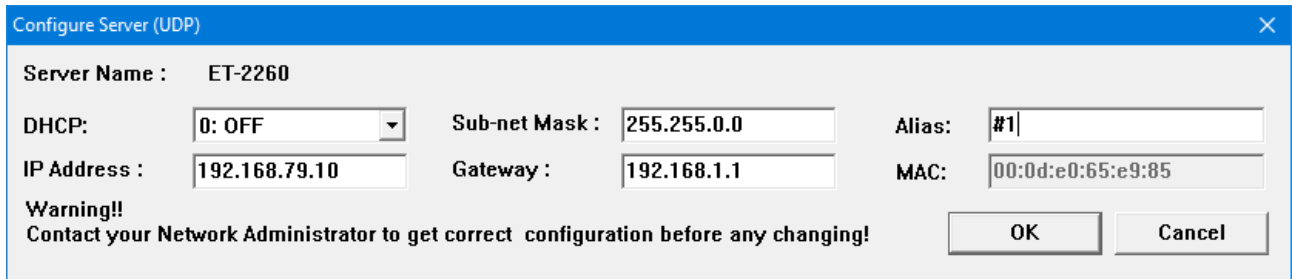

Step 4

Reset the Init/Run switch on the ET-2200 module to the "Run" position and reboot the device.

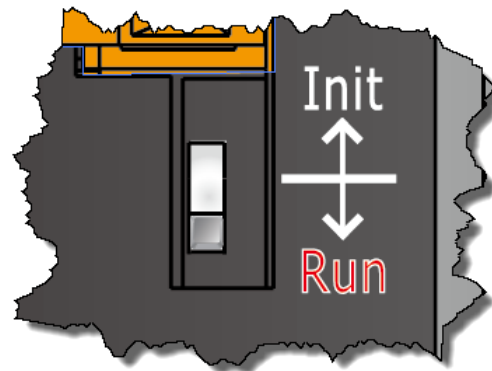

Step 5

Log in to the web configuration pages for the ET-2200 module, using the default web password, "Admin".

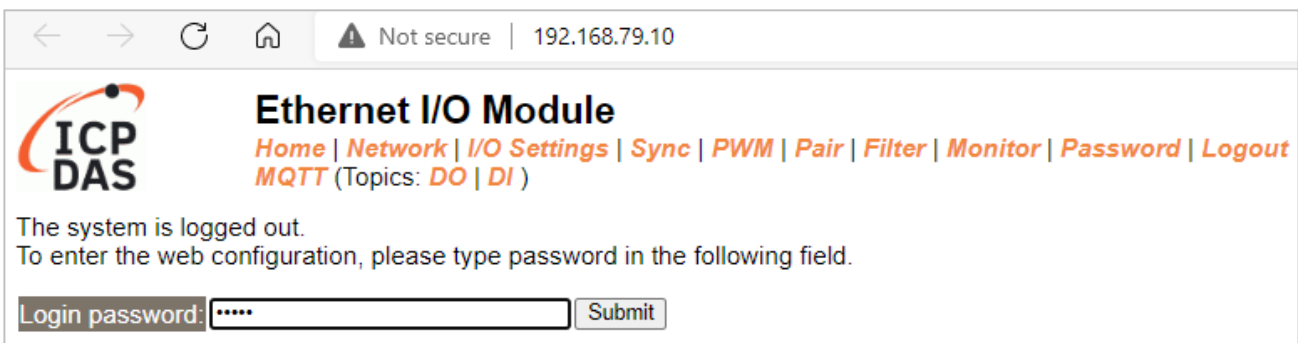

A.2 How to update the firmware via Ethernet?

If the module is not functioning correctly (e.g. there is no response to a search request, or if the system LED is continuously displayed as either OFF or ON), download new firmware from the ICPDAS website. <http://www.icpdas.com/en/download/show.php?num=2626>

To update the Firmware for your ET-2200 module, connect the ET-2200 module and PC in the same sub-network. Please note that there should be only one network card on the PC. Then, download and install the **eSearch Utility**:

http://www.icpdas.com/en/product/guide+Software+Utility_Driver+eSearch__Utility

Step 1: Run the **eSearch utility** and click on the **Search Server** button to find the ET-2200 module.

Step 2: Right-click on the module name and select **Firmware Update**.

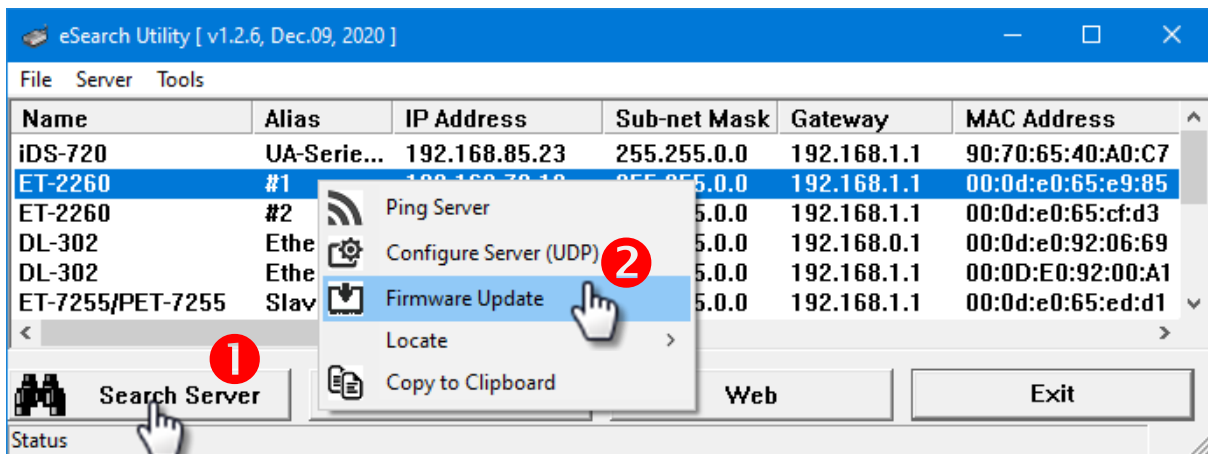

Step 3: Select the firmware file and click on the **Open** button.

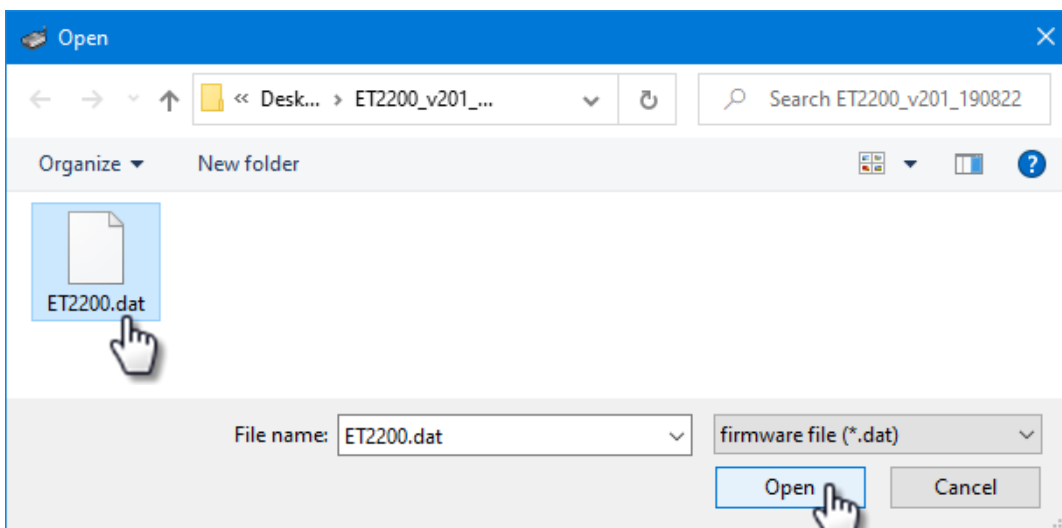

Step 4: Make sure the IP address and MAC address are correct. Click on the OK button.

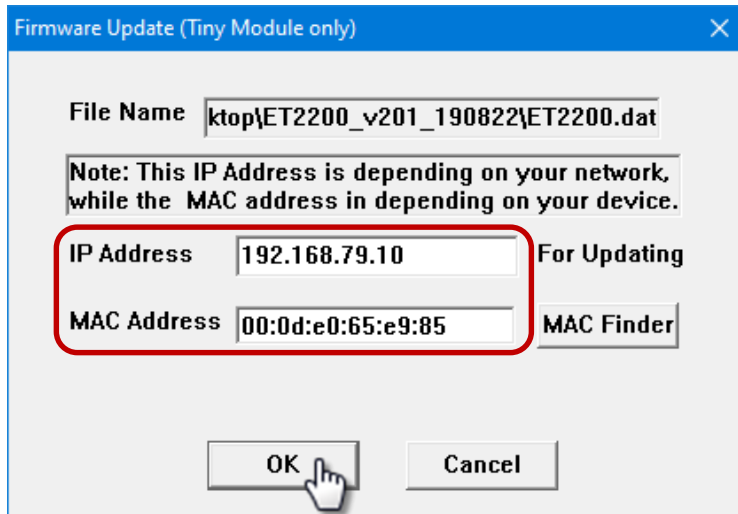

Step 5: The progress 0% will be displayed in a command prompt window. Follow the steps.

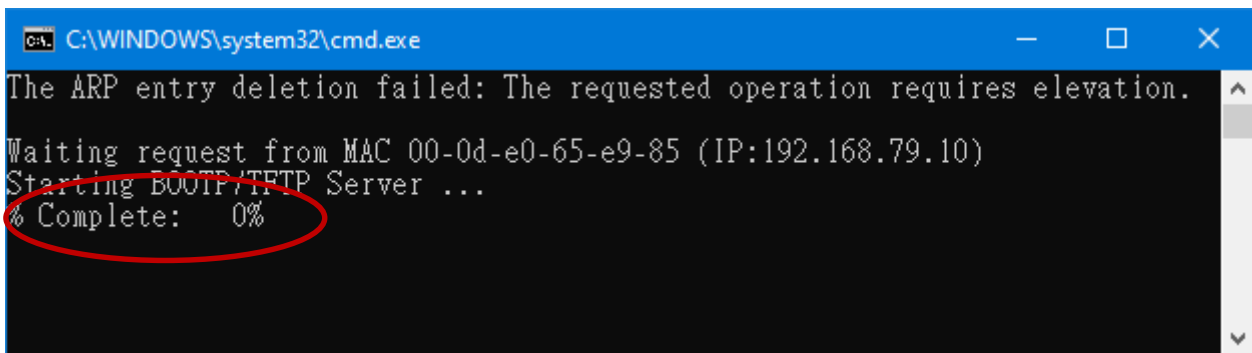

Method 1 - Local Update:

Set the Init/Run switch to the "Init" position and reboot the module to start the update.

Method 2 - Remote Update:

Click the **Web** button and log into the web page of the module, and then click the **Update** button on the **Network** page to start the update.

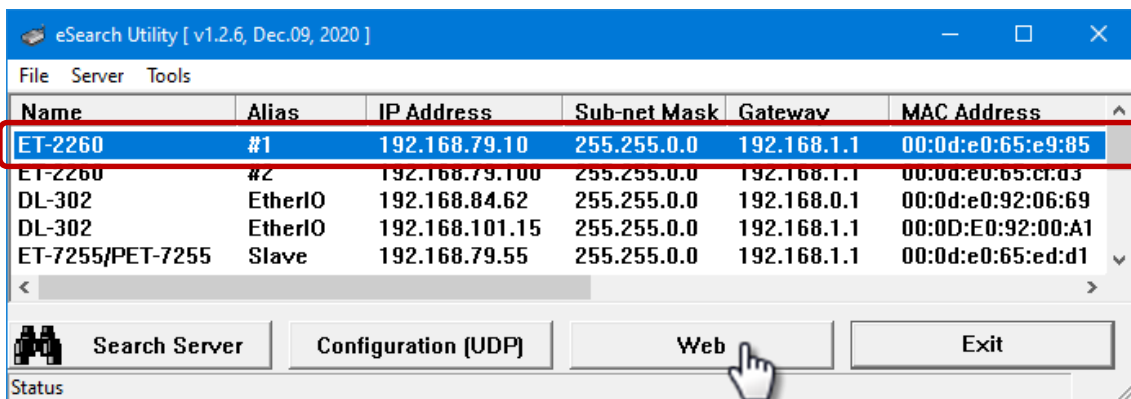

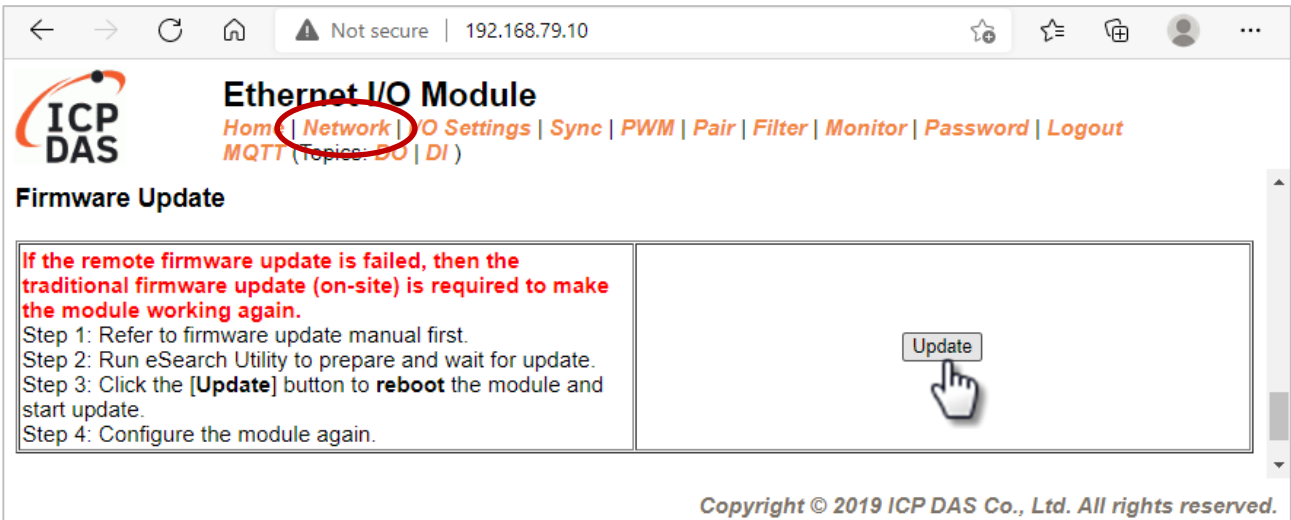

Step 6: After the update is complete, press any key to close the window. For the local update, Set the Init/Run switch to the "Run" position and reboot the module.

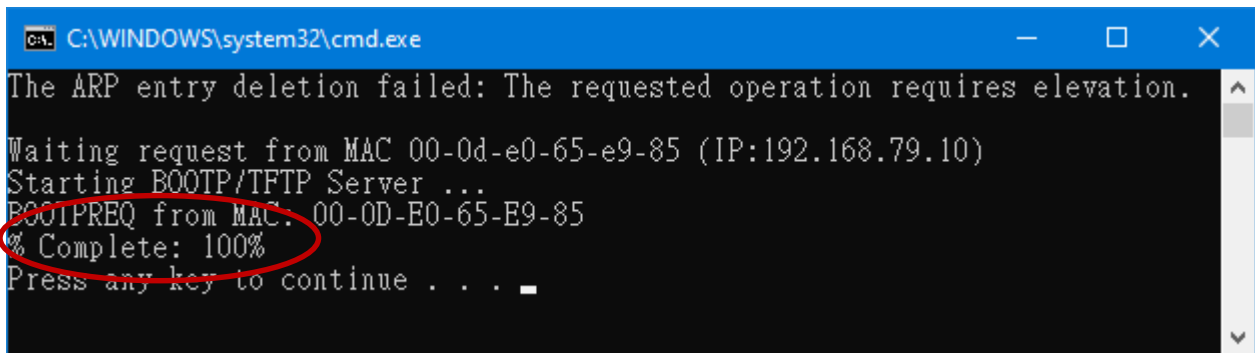

Step 7: Search the module again and log into the web page by using the eSearch Utility. After that, the user can check the **Firmware Version** on the **Home** page.

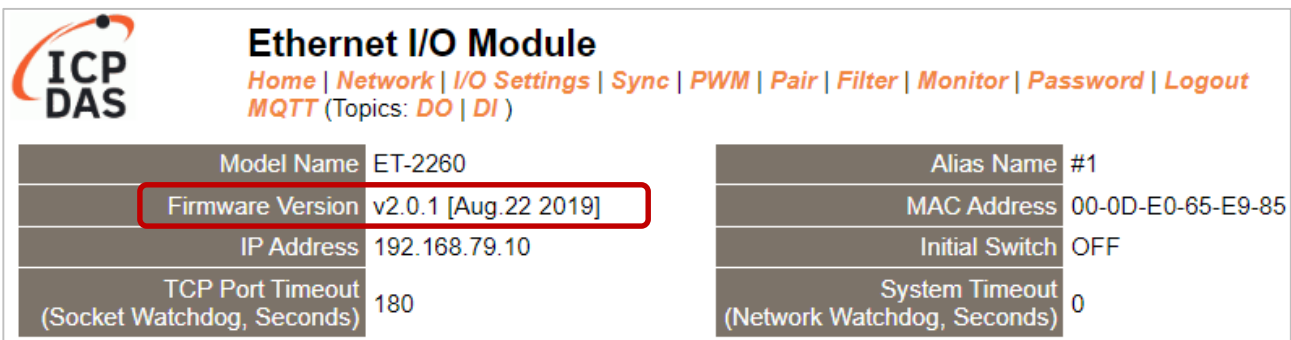

A.3 Why is the Host computer unable to ping or search for the ET-2200 module?

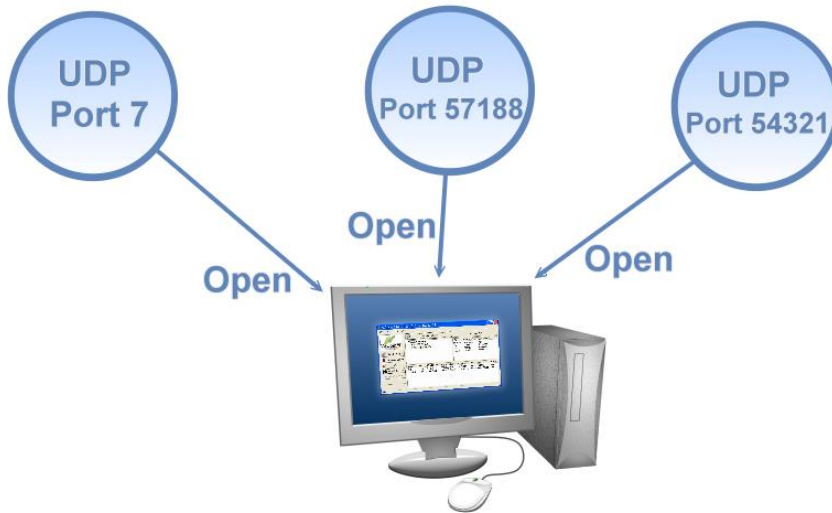

The Host computer can only establish communication with a module through specific ports. Confirm with your network administrator that access to UDP Port 7, Port 57188, and Port 54321 is not being denied by another network device.

The following provides more detailed information related to TCP/UDP ports:

TCP Port:

Port Number	Description
80	HTTP (Hyper Text Transport Protocol)
502	Modbus Data Port

UDP Port:

Port Number	Description
7	Echo (Ping)
57188	UDP Search Request
54321	UDP Search Response

A.4 What is Digital-Input Filter (DI Filter)?

A: An input signal can come from a myriad of sources, such as buttons, switches, sensors, relays, etc. Each of these types of mechanical devices also contributes to a common problem - “**contact bounce**”.

The switch between Digital Input states is usually accompanied by several unwanted pulses, known as “switch bounce”. In certain environments and situations, these input signals may inevitably generate an unstable signal or noise, which can potentially cause incorrect data counting or operation failure. Consequently, these errors must be removed from the input signals, especially if the signals are used in crucial applications.

A low-pass Digital Input filter is a software function that can be used to eliminate high-frequency interference from input signals. The input state will only be changed when the width of any new signal is greater than the value specified as the filtering time, meaning that short, high-frequency interference pulses will be ignored, as illustrated in the diagram below. This is especially useful when attempting to eliminate contact bounce.

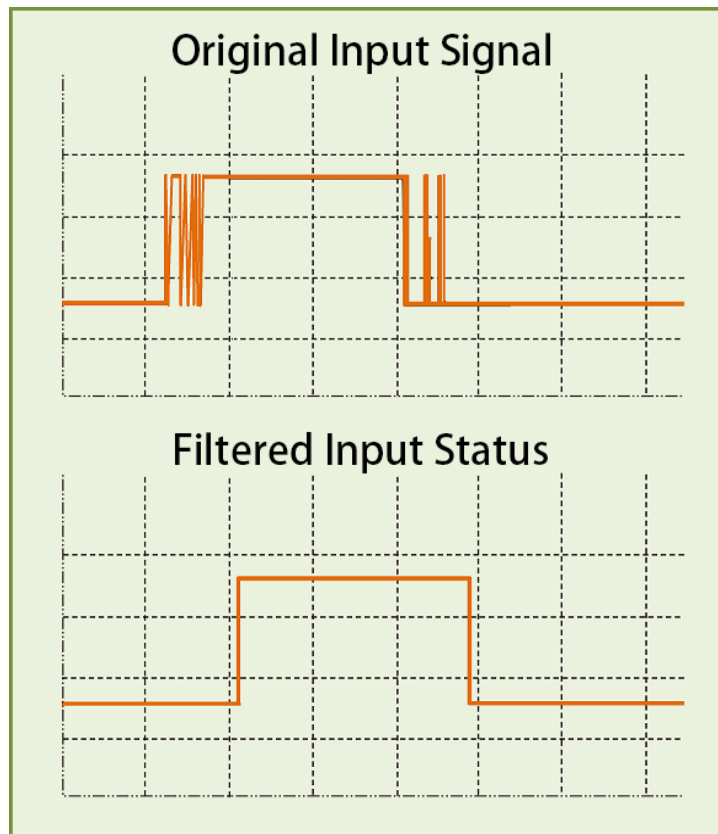

Appendix B: Revision History

The table below shows the revision history.

Revision	Date	Description
1.6.0	Mar. 2023	<ol style="list-style-type: none"> Revise Section 6.4.1. The sampling rate of PET-2217 in fast mode is 200 Hz, and in normal mode is 20 Hz. Revise Section 2.2. Modify the URL of the data sheet to the English version Revise Section 6.4.2. The address 31000-31109 and 41000-41109 has been modified to 34097-34206 and 44097-44206
	Jan. 2023	Simplify the content of the hardware information in Chapter 2
	Dec. 2022	<ol style="list-style-type: none"> Revise Sections 4.8, 5.1 to 5.4 Add Section 5.5 Shared Memory
	Nov. 2022	Add Section 4.18 SNMP
	Sep. 2022	Add the model ET-2217 (The AI module)
	Jun. 2022	Add the model ET-2224/ ET-2228 (The AO module)
	Apr. 2022	Revise Sections 2.2, 2.3, 2.4, and 2.6, add new models
	Jan. 2022	<ol style="list-style-type: none"> Add Modbus addresses in Section 6.4 Add Section 6.5 Analog Input Type and Data Format Table
	Nov. 2021	Support MQTT protocol
	Oct. 2021	Add Section 1.3 Application
	Sep. 2021	<ol style="list-style-type: none"> Add the information about ET-2217CI/ 2217CI-4 Add Chapter 6.4 Modbus Register (AIO) Add Appendix A.2 ~ A.4
1.5.0	Jun. 2020	Modify the official website-related links.
1.4.0	Sep. 2019	Added the information on the MQTT function.
1.3.0	Jun. 2018	Added the hardware information about the ET-2261-16.

Revision	Date	Description
1.2.0	Jul. 2017	<ol style="list-style-type: none">1. Add the software and hardware information about the ET-2242U and ET-2255U.2. Updated the information about the Firmware Version v1.4.6 [Jun.16, 2017] in Chapter 4 Web Configuration.3. Add Chapter Appendix A: Troubleshooting.4. Add Chapter Appendix B: Revision History.
1.1.3	Feb. 2016	<ol style="list-style-type: none">1. Added the software and hardware information about the ET-2254P, ET-2261 and ET-2268.2. Updated the information about the Firmware Version v1.3.9 [Jan.20, 2016] in Chapter 4 Web Configuration.
1.1.0	Nov. 2015	Add the software and hardware information about the ET-2242, ET-2251 and ET-2255.
1.0.0	Sep. 2015	Initial issue