

# DL-1000

PM1/PM2.5/PM10/CO/CO2/HCHO/NH3/H2S/TVOC  
/Temperature/Humidity/Dew Point Data Logger

## User Manual



Version: 1.1.0

Date: Aug. 2020

---

---

## **Warranty**

All products manufactured by ICP DAS are warranted against defective materials for a period of one year from the date of delivery to the original purchaser.

## **Warning**

ICP DAS assumes no liability for damages consequent to the use of this product.

ICP DAS reserves the right to change this manual at any time without notice. The information furnished by ICP DAS is believed to be accurate and reliable. However, no responsibility is assumed by ICP DAS for its use, not for any infringements of patents or other rights of third parties resulting from its use.

## **Copyright**

Copyright © 2020 by ICP DAS. All rights are reserved.

## **Contact Us**

If you have any questions, please feel free to contact us via email at:

[Service@icpdas.com](mailto:Service@icpdas.com)

---

# Contents

|  |    |
|--|----|
| 1. Introduction.....   | 5  |
| 2. Hardware.....   | 10 |
| 2.1 Specifications.....  | 10 |
| 2.2 Appearance.....  | 21 |
| 2.3 Dimensions (unit: mm) .....  | 29 |
| 2.4 Cabling for Power and Network .....  | 30 |
| 3. Configuration via Web Browser .....   | 32 |
| 3.1 Search the DL-1000 logger.....   | 32 |
| 3.2 Logging into the DL-1000 .....   | 33 |
| 3.3 Home.....  | 34 |
| 3.4 Network.....   | 36 |
| 3.5 MQTT .....   | 38 |
| 3.6 I/O Settings .....   | 42 |
| 3.7 Accessible IP.....   | 47 |
| 3.8 Monitor .....  | 48 |
| 3.9 Change Password.....   | 48 |
| 3.10 Logout.....   | 49 |
| 4. Configuration via RS-485.....   | 50 |
| 5. Monitoring via Mobile Devices .....   | 60 |
| 6. Utility to Get/Manage Data Log .....  | 61 |
| Q1: What is ABC (Automatic Baseline Correction)? .....                           | 72 |
| Q2: Why I need to enable the ABC?.....   | 72 |
| Q3: Does the DL-1022/DL-1023 enable the ABC as the factory default setting?..... | 72 |
| Q4: What to do when the ABC is no work?.....                                     | 72 |
| Q5: How to set the password? .....   | 73 |
| Q6: How to cancel the password?.....   | 73 |
| Q7: How to set the Accessible IP? .....  | 74 |
| Q8: How to delete the Accessible IP settings?.....                               | 74 |
| Q9: How to clear the data logged in a DL-1000 module? .....                      | 75 |
| Q10 How to download firmware into a DL-1000 module?.....                         | 75 |
| Appendix A: DCON Command Sets .....  | 79 |
| A-1. DL-1020 DCON Command Sets .....   | 79 |
| A-2. DL-1021 DCON Command Sets .....   | 84 |
| A-3. DL-1022 DCON Command Sets .....   | 89 |

---

|   |     |
|---|-----|
| A-4. DL-1023 DCON Command Sets .....                | 94  |
| A-5. DL-1038 DCON Command Sets .....                | 99  |
| Appendix B: ModbusMasterToolPC.....                 | 104 |
| Appendix C: Modbus Address Table .....              | 108 |
| C-1. DL-1020 Modbus Address Mappings (Base 1) ..... | 108 |
| C-2. DL-1021 Modbus Address Mappings (Base 1) ..... | 114 |
| C-3. DL-1022 Modbus Address Mappings (Base 1) ..... | 120 |
| C-4. DL-1023 Modbus Address Mappings (Base 1) ..... | 126 |
| C-5. DL-1038 Modbus Address Mappings (Base 1) ..... | 132 |
| Revision History .....                              | 137 |



# 1. Introduction

The DL-1000 is a series of particle and gas measurement module that can measure the concentration of aerosols in the air, such as: PM2.5, PM1, PM10 and the number of particles (0.3µm, 0.5µm, 1µm, 2.5µm, 5µm, 10µm). In addition, various fume concentrations related to human health can also be measured. For example: CO/CO2/HCHO/NH3/H2S/TVOC DL-1000 can record data and send alarm when concentration is too high. It can be used to record PM1/2.5/10, CO, CO2, HCHO, TVOC, NH3, H2S, Temperature, Humidity and Dew Point information, including date and time stamps, and are able to store up to 180,000 downloadable records. Real-time data can be accessed from the DL-1000 series Data Logger from anywhere and at any time using the free Windows software, the iOS App or the Android App, as long as they are connected to the same local network as the Data Logger. Support is provided for popular industrial protocols such as DCON, Modbus RTU, and Modbus TCP, as well as the emerging machine-to-machine (M2M)/IoT (Internet of Things) connectivity protocol-MQTT. The DL-1000 series Data Logger can be connected via widely used communication interfaces including RS-485, Ethernet and PoE, meaning that the device can be easily integrated into existing HMI or SCADA systems, and is easy to be maintained in a distributed control system. The DL-1000 series is designed for industrial applications in harsh environments that provides IP43 grade protection approval. The rugged RJ-45 ensures tight, robust connections, and guarantees reliable operation, even for applications that are subject to high vibration and shock.

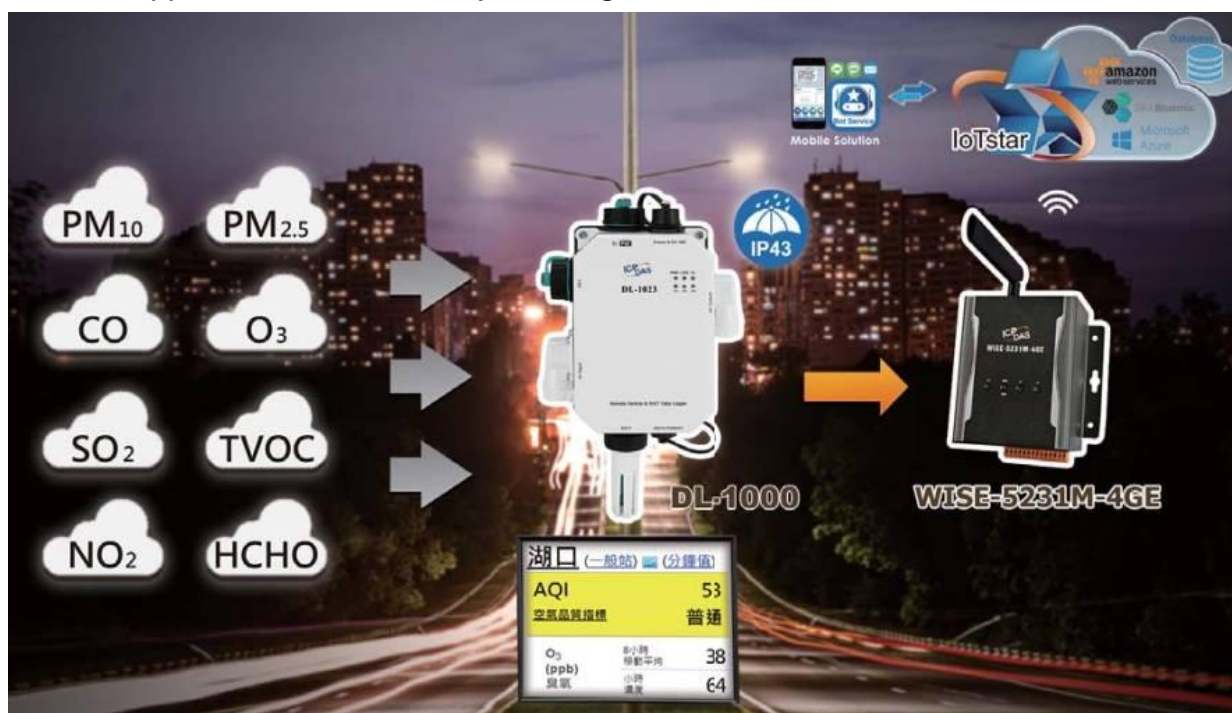

## Characteristics

- ▶ Able to record PM1/2.5/10, CO, CO<sub>2</sub>, HCHC, NH<sub>3</sub>, H<sub>2</sub>S, TVOC, Temperature, Humidity, and Dew Point Measurements
- ▶ PM1, M2.5, PM10 measurement range: 0 to 1000 ug/m<sup>3</sup>
- ▶ CO measurement range: 0 to 1000 ppm
- ▶ CO<sub>2</sub> measurement range: 0 to 9999 ppm
- ▶ TVOC measurement range: 0 to 60000 ppb
- ▶ Non-dispersive Infrared (NDIR) sensor with Automatic Baseline Correction algorithm for CO<sub>2</sub> measurement
- ▶ TVCO : Metal-Oxide Sensor
- ▶ Electrochemical Sensor
- ▶ Up to 180,000 records with date and time stamps
- ▶ Web-based Configuration Interface
- ▶ Simple and Powerful Software Utility, iOS APP and Android App Included
- ▶ Supports the DCON, Modbus RTU/TCP, and MQTT Protocols
- ▶ Includes RS-485/Ethernet/PoE Communication Interfaces
- ▶ Relay Output for Audible/Visual Alarm or IAQ Device Control
- ▶ Includes redundant power inputs: PoE (IEEE 802.3af, Class 1) and DC input
- ▶ IP 43 Protection Approval

## Features

### ▶ NDIR Sensor

NDIR (Non-Dispersion Infrared) is based on one of the natural properties of CO<sub>2</sub> molecules: CO<sub>2</sub> molecules absorb light at a specific wavelength of 4.26 μm. This wavelength is in the infrared (IR) range. High concentrations of CO<sub>2</sub> molecules absorb more light than low concentrations. NDIR sensor can detect fast and accurately in a wide range of CO<sub>2</sub> concentration.

### ▶ Built-in Web Server

With the built-in Web server, users can easily log in to the DL-1000 module via a standard web browser to monitor the data and configure the settings without install any software in the terminal.

### ▶ Get Real-time Data Anywhere and Anytime

iAir App for iOS or Android Phones or Tablets is free and easy to install, it can obtain the real-time data from DL-1000 modules over a Wi-Fi network anytime and anywhere. The iAir App can link to the DL-1000 modules by specifying IP addresses or by searching all the modules connected to the same Ethernet segment.

### ▶ Data Logging Software

The DL300 Utility can be used to configure the modules, monitor real-time data and show the run chart, log alarm events, group DL-1000 modules so that the status of distribution groups can be viewed and managed. The utility also allows the log data to be downloaded and exported to a .CSV file that can then be imported into any industry-standard software or spread sheet for analysis.

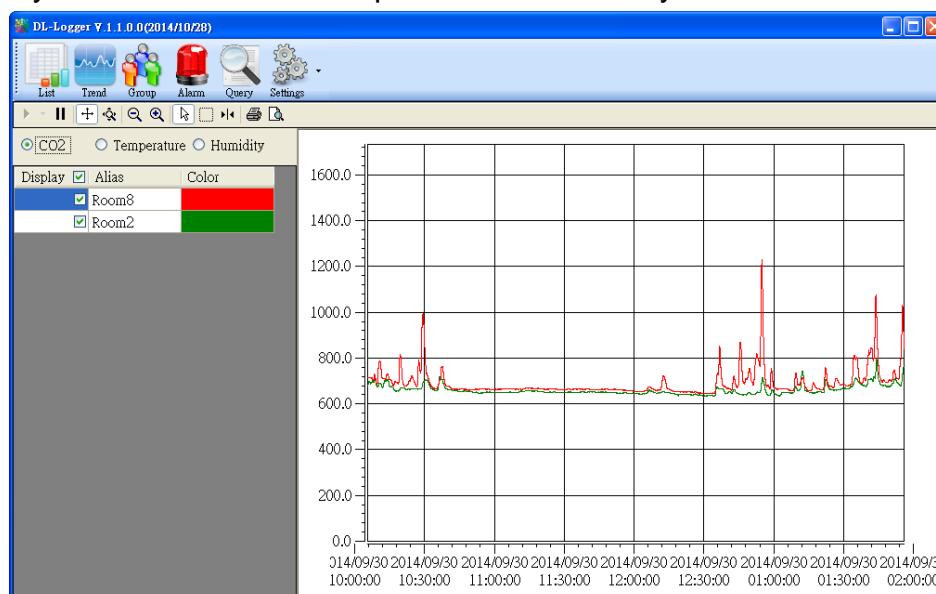

▶ **Easy integration with SCADA software**

Modbus is one of the most popular protocols used in the industrial world. Supporting traditional serial protocols of RS-485 and Ethernet protocols allow the DL-1000 series well-integrated into the HMI/SCADA systems.

▶ **Alarm**

DL-1000 series allows users to set high alarm level for CO/CO<sub>2</sub>/TVOC/PM1/PM2.5/PM10/Temperature/ Humidity/Dew Point and low alarm level for Temperature /Humidity/Dew Point, and to enable/disable the alarm functions. An Alarm LED indicator on the front of the DL-1000 module will flash when an alarm event is activated, and a relay output related to all alarm events can be use to tap an alarm light/sound or control the IAQ devices such as ventilators, air cleaners, and filters. Beep alarm is available when the CO/CO<sub>2</sub>/TVOC/PM1/PM2.5/PM10 high level alarm occurs.

▶ **Screen Lock**

Users can secure a DL-1000 module by setting a screen lock via the web interface. If the lock is set, users need to enter the correct password when they would like to configure the DL-1000 module.

▶ **Automatic Baseline Correction**

The built-in ABC algorithm makes the CO<sub>2</sub> sensor on the DL-1022 and DL-1023 maintenance-free. In most indoor applications, the carbon dioxide level drops to nearly outside air - 400 ppm, and then the ABC algorithm constantly keeps track of the lowest reading and slowly corrects it as the expected fresh air value of 400 ppm. The ABC algorithm can not apply for the places where are no periods that the CO<sub>2</sub> concentration drops to background level such as greenhouses, hospitals, 24-hour operation factories or stories. The ABC function needs be disabled where the spaces the CO<sub>2</sub> concentration may be elevated at all times.

▶ **Easy Wiring**

Support for RS-485, Ethernet and Power over Ethernet (PoE) interfaces for users to choose the appropriate one to meet the field requirements.



▶ **Power over Ethernet (PoE)**

The DL-1000 series features true IEEE802.3af-compliant (classification, Class 1) PoE technology that allows both power and data to be carried over a single Ethernet cable. PoE provides a unified power system, as well as backup provisions for critical building functions, without any additional cables, outlets or connections. It can reduce the power supply wiring and maintenance costs, and improve system scalability.

▶ **Support for MQTT protocol**

MQTT is a protocol designed for the efficient exchange of real-time data with sensor and mobile devices. It runs over TCP/IP and is in widest use on the "machine-to-machine" (M2M) and "Internet of Things" applications today

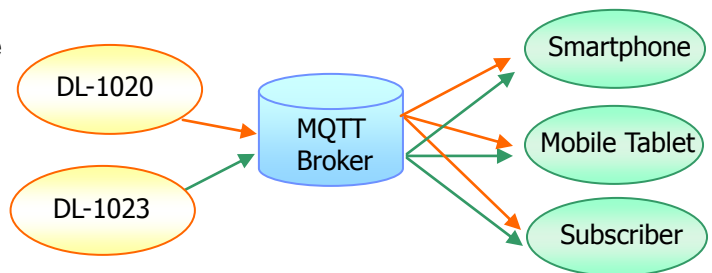

▶ **Replaceable Filter Patch (FLT-C001)**

Generally, the PM2.5 measuring sensor on the market is usually installed in outdoor applications. Because the outdoor air is quite dusty, the measuring channel of PM2.5 sensor is easily clogged by aerosol, resulting in continued alarms for the heavy concentration. Due to the error data from the clogged sensor, this module is returned to the factory for repair. Downtime during the repair period often causes significant cost and losses. In order to solve this problem, ICP DAS design the CL-200 series and DL-1000 series with replaceable patch, FLT-C001, which makes it easy for users to replace them without uninstall the devices. Cost of repair and time can be reduced by this innovated mechanical design.



## 2. Hardware

### 2.1 Specifications

| Model                                 | DL-1020  | DL-1020-WF |
|---------------------------------------|--|------------|
| <b>PM1 / PM2.5 / PM10 Measurement</b> |  |            |
| Range                                 | 0 to 1,000µg/m <sup>3</sup> ( Laser Type)            |            |
| Resolution                            | 1µg/m <sup>3</sup>                                   |            |
| Accuracy                              | ± 10% of FSR   |            |
| Response Time                         | 1 sec  |            |
| Warm-up Time                          | 20 sec   |            |
| Life time                             | 5 years, Customer has to replace the filter patch.   |            |
| <b>Particle</b>                       |  |            |
| Sizes                                 | 0.3µm, 0.5µm,,1µm, 2.5µm,,5µm, 10µm                  |            |
| Life Time                             | 5 years, the filter patch (FLT-C001) by replaceable. |            |
| <b>Temperature Measurement</b>        |  |            |
| Range                                 | -20 to +50°C   |            |
| Resolution                            | 0.1°C  |            |
| Accuracy                              | ±0.6°C   |            |
| <b>Relative Humidity Measurement</b>  |  |            |
| Range                                 | 0 to 100% RH, Non-condensing                         |            |
| Resolution                            | 0.1% RH, Non-condensing                              |            |
| Accuracy                              | ±5% RH, Non-condensing                               |            |
| Life time                             | 10 years   |            |
| <b>Dew Point</b>                      |  |            |
| Range                                 | Calculated using temperature and relative humidity   |            |
| Resolution                            | 0.1°C  |            |
| <b>System</b>                         |  |            |
| CO Alarm                              | -  |            |
| CO <sub>2</sub> Alarm                 | -  |            |
| PM1/ PM 2.5/ PM 10 Alarm              | Yes  |            |
| Real Time Clock                       | Yes  |            |
| Data Logger                           | Yes, 180,000 Records                                 |            |
| Alarm Relay Output                    | PhotoMos Relay × 4, 100 VDC @ 1 A                    |            |

| <b>Communication</b>       |         |   |                           |
|----------------------------|---------|---|---------------------------|
| RS-485 Port                |         | Baud Rate = 1200 ~ 115200 bps   |                           |
| Ethernet Port              |         | 10/100 Base-TX, 8-Pin RJ-45 x1(Auto-negotiating, Auto-MDI/MDIX, LED indicators) |                           |
| Security                   |         | IP filter (whitelist) and Password (web)  |                           |
| Protocol                   |         | Modbus/RTU(RS-485), Modbus TCP(Ethernet) and MQTT(Ethernet)                     |                           |
| Dual Watchdog              |         | Yes, Module (2.3 sec), Communication (Programmable)                             |                           |
| Wireless Interface         |         | -   | Wi-Fi                     |
| Standard Supported         |         | -   | IEEE 802.11 b/g/n         |
| Wireless Mode              |         | -   | Infrastructure/Limited AP |
| Wireless Security          |         | -   | WEP, WPA ,WPA2            |
| Transmission Range         |         | -   | 50 m (LOS)                |
| <b>LED Indicators</b>      |         |   |                           |
| PWR                        |         | Green for normal operation  |                           |
| Link                       |         | Green for the Ethernet-linked   |                           |
| S1 ~ S4                    |         | Red for an alarm condition  |                           |
| <b>Electrical</b>          |         |   |                           |
| Powered via Terminal Block |         | +12 to +48 VDC  |                           |
| Powered via PoE            |         | IEEE 802.3af, Class 1 (require a PoE switch or injector)                        |                           |
| Power Consumption          | PoE     | 3.0 W   | 3.2 W                     |
|                            | Non-PoE | 2.8 W   | 3.0 W                     |
| <b>Mechanical</b>          |         |   |                           |
| Dimensions (L x W x H)     |         | 211 mm x 130 mm x 70 mm   |                           |
| Installation               |         | Ceiling Mounting or Wall Mounting   |                           |
| <b>Environment</b>         |         |   |                           |
| Operating Temperature      |         | -20 to +50°C  |                           |
| Storage Temperature        |         | -30 to +75°C  |                           |
| Humidity                   |         | 10 to 90% RH, Non-condensing  |                           |
| Protection Class           |         | IP43  |                           |

| Model                                 | DL-1021  | DL-1021-WF |
|---------------------------------------|--|------------|
| <b>PM1 / PM2.5 / PM10 Measurement</b> |  |            |
| Range                                 | 0 to 1,000µg/m <sup>3</sup> ( Laser Type)            |            |
| Resolution                            | 1µg/m <sup>3</sup>                                   |            |
| Accuracy                              | ± 10% of FSR   |            |
| Response Time                         | 1 sec  |            |
| Warm-up Time                          | 20 sec   |            |
| Life time                             | 5 years, Customer has to replace the filter patch.   |            |
| <b>Particle</b>                       |  |            |
| Sizes                                 | 0.3µm, 0.5µm,,1µm, 2.5µm,,5µm, 10µm                  |            |
| Life Time                             | 5 years, the filter patch (FLT-C001) by replaceable. |            |
| <b>CO Measurement</b>                 |  |            |
| Range                                 | 0 to 1000 ppm (Electrochemical)                      |            |
| Resolution                            | 1 ppm  |            |
| Accuracy                              | ±5% of measured value                                |            |
| Response Time                         | 30 sec   |            |
| Warm-up Time                          | 60 sec   |            |
| Life Time                             | 5 years  |            |
| <b>Temperature Measurement</b>        |  |            |
| Range                                 | -20 to +50°C   |            |
| Resolution                            | 0.1°C  |            |
| Accuracy                              | ±0.6°C   |            |
| <b>Relative Humidity Measurement</b>  |  |            |
| Range                                 | 0 to 100% RH, Non-condensing                         |            |
| Resolution                            | 0.1% RH, Non-condensing                              |            |
| Accuracy                              | ±5% RH, Non-condensing                               |            |
| Life time                             | 10 years   |            |
| <b>Dew Point</b>                      |  |            |
| Range                                 | Calculated using temperature and relative humidity   |            |
| Resolution                            | 0.1°C  |            |
| <b>System</b>                         |  |            |
| CO Alarm                              | Yes  |            |
| CO <sub>2</sub> Alarm                 | -  |            |

|                            |   |                           |       |
|----------------------------|---|---------------------------|-------|
| PM1/ PM 2.5/ PM 10 Alarm   | Yes   |                           |       |
| Real Time Clock            | Yes   |                           |       |
| Data Logger                | Yes, 180,000 Records  |                           |       |
| Alarm Relay Output         | PhotoMos Relay × 4, 100 VDC @ 1 A   |                           |       |
| <b>Communication</b>       |   |                           |       |
| RS-485 Port                | Baud Rate = 1200 ~ 115200 bps   |                           |       |
| Ethernet Port              | 10/100 Base-TX, 8-Pin RJ-45 x1(Auto-negotiating, Auto-MDI/MDIX, LED indicators) |                           |       |
| Security                   | IP filter (whitelist) and Password (web)  |                           |       |
| Protocol                   | Modbus/RTU(RS-485), Modbus TCP(Ethernet) and MQTT(Ethernet)                     |                           |       |
| Dual Watchdog              | Yes, Module (2.3 sec), Communication (Programmable)                             |                           |       |
| Wireless Interface         | -   | Wi-Fi                     |       |
| Standard Supported         | -   | IEEE 802.11 b/g/n         |       |
| Wireless Mode              | -   | Infrastructure/Limited AP |       |
| Wireless Security          | -   | WEP, WPA ,WPA2            |       |
| Transmission Range         | -   | 50 m (LOS)                |       |
| <b>LED Indicators</b>      |   |                           |       |
| PWR                        | Green for normal operation  |                           |       |
| Link                       | Green for the Ethernet-linked   |                           |       |
| S1 ~ S4                    | Red for an alarm condition  |                           |       |
| <b>Electrical</b>          |   |                           |       |
| Powered via Terminal Block | +12 to +48 VDC  |                           |       |
| Powered via PoE            | IEEE 802.3af, Class 1 (require a PoE switch or injector)                        |                           |       |
| Power Consumption          | PoE   | 3.1 W                     | 3.3 W |
|                            | Non-PoE   | 2.9 W                     | 3.1 W |
| <b>Mechanical</b>          |   |                           |       |
| Dimensions (L x W x H)     | 211 mm x 130 mm x 70 mm   |                           |       |
| Installation               | Ceiling Mounting or Wall Mounting   |                           |       |
| <b>Environment</b>         |   |                           |       |
| Operating Temperature      | -20 to +50°C  |                           |       |
| Storage Temperature        | -30 to +75°C  |                           |       |
| Humidity                   | 10 to 90% RH, Non-condensing  |                           |       |
| Protection Class           | IP43  |                           |       |

| Model                                 | DL-1022  | DL-1022-WF |
|---------------------------------------|--|------------|
| <b>PM1 / PM2.5 / PM10 Measurement</b> |  |            |
| Range                                 | 0 to 1,000µg/m <sup>3</sup> ( Laser Type)            |            |
| Resolution                            | 1µg/m <sup>3</sup>                                   |            |
| Accuracy                              | ± 10% of FSR   |            |
| Response Time                         | 1 sec  |            |
| Warm-up Time                          | 20 sec   |            |
| Life time                             | 5 years, Customer has to replace the filter patch.   |            |
| <b>Particle</b>                       |  |            |
| Sizes                                 | 0.3µm, 0.5µm,,1µm, 2.5µm,,5µm, 10µm                  |            |
| Life Time                             | 5 years, the filter patch (FLT-C001) by replaceable. |            |
| <b>CO<sub>2</sub> Measurement</b>     |  |            |
| Range                                 | 0 ~ 9999 ppm (NDIR)                                  |            |
| Resolution                            | 1 ppm  |            |
| Accuracy                              | ±30 ppm ±3% of measured val                          |            |
| Response Time                         | 120 sec  |            |
| Warm-up Time                          | 300 sec  |            |
| Life Time                             | 15 years   |            |
| <b>Temperature Measurement</b>        |  |            |
| Range                                 | -20 to +50°C   |            |
| Resolution                            | 0.1°C  |            |
| Accuracy                              | ±0.6°C   |            |
| <b>Relative Humidity Measurement</b>  |  |            |
| Range                                 | 0 to 100% RH, Non-condensing                         |            |
| Resolution                            | 0.1% RH, Non-condensing                              |            |
| Accuracy                              | ±5% RH, Non-condensing                               |            |
| Life time                             | 10 years   |            |
| <b>Dew Point</b>                      |  |            |
| Range                                 | Calculated using temperature and relative humidity   |            |
| Resolution                            | 0.1°C  |            |
| <b>System</b>                         |  |            |
| CO Alarm                              | -  |            |
| CO <sub>2</sub> Alarm                 | Yes  |            |

|                            |   |                           |       |
|----------------------------|---|---------------------------|-------|
| PM1/ PM 2.5/ PM 10 Alarm   | Yes   |                           |       |
| Real Time Clock            | Yes   |                           |       |
| Data Logger                | Yes, 180,000 Records  |                           |       |
| Alarm Relay Output         | PhotoMos Relay × 4, 100 VDC @ 1 A   |                           |       |
| <b>Communication</b>       |   |                           |       |
| RS-485 Port                | Baud Rate = 1200 ~ 115200 bps   |                           |       |
| Ethernet Port              | 10/100 Base-TX, 8-Pin RJ-45 x1(Auto-negotiating, Auto-MDI/MDIX, LED indicators) |                           |       |
| Security                   | IP filter (whitelist) and Password (web)  |                           |       |
| Protocol                   | Modbus/RTU(RS-485), Modbus TCP(Ethernet) and MQTT(Ethernet)                     |                           |       |
| Dual Watchdog              | Yes, Module (2.3 sec), Communication (Programmable)                             |                           |       |
| Wireless Interface         | -   | Wi-Fi                     |       |
| Standard Supported         | -   | IEEE 802.11 b/g/n         |       |
| Wireless Mode              | -   | Infrastructure/Limited AP |       |
| Wireless Security          | -   | WEP, WPA ,WPA2            |       |
| Transmission Range         | -   | 50 m (LOS)                |       |
| <b>LED Indicators</b>      |   |                           |       |
| PWR                        | Green for normal operation  |                           |       |
| Link                       | Green for the Ethernet-linked   |                           |       |
| S1 ~ S4                    | Red for an alarm condition  |                           |       |
| <b>Electrical</b>          |   |                           |       |
| Powered via Terminal Block | +12 to +48 VDC  |                           |       |
| Powered via PoE            | IEEE 802.3af, Class 1 (require a PoE switch or injector)                        |                           |       |
| Power Consumption          | PoE   | 3.1 W                     | 3.3 W |
|                            | Non-PoE   | 2.9 W                     | 3.1 W |
| <b>Mechanical</b>          |   |                           |       |
| Dimensions (L x W x H)     | 211 mm x 130 mm x 70 mm   |                           |       |
| Installation               | Ceiling Mounting or Wall Mounting   |                           |       |
| <b>Environment</b>         |   |                           |       |
| Operating Temperature      | -20 to +50°C  |                           |       |
| Storage Temperature        | -30 to +75°C  |                           |       |
| Humidity                   | 10 to 90% RH, Non-condensing  |                           |       |
| Protection Class           | IP43  |                           |       |

| Model                                 | DL-1023  | DL-1023-WF |
|---------------------------------------|--|------------|
| <b>PM1 / PM2.5 / PM10 Measurement</b> |  |            |
| Range                                 | 0 to 1,000µg/m <sup>3</sup> ( Laser Type)            |            |
| Resolution                            | 1µg/m <sup>3</sup>                                   |            |
| Accuracy                              | ± 10% of FSR   |            |
| Response Time                         | 1 sec  |            |
| Warm-up Time                          | 20 sec   |            |
| Life time                             | 5 years, Customer has to replace the filter patch.   |            |
| <b>Particle</b>                       |  |            |
| Sizes                                 | 0.3µm, 0.5µm,,1µm, 2.5µm,,5µm, 10µm                  |            |
| Life Time                             | 5 years, the filter patch (FLT-C001) by replaceable. |            |
| <b>CO Measurement</b>                 |  |            |
| Range                                 | 0 to 1000 ppm (Electrochemical)                      |            |
| Resolution                            | 1 ppm  |            |
| Accuracy                              | ±5% of measured value                                |            |
| Response Time                         | 30 sec   |            |
| Warm-up Time                          | 60 sec   |            |
| Life Time                             | 5 years  |            |
| <b>CO<sub>2</sub> Measurement</b>     |  |            |
| Range                                 | 0 ~ 9999 ppm (NDIR)                                  |            |
| Resolution                            | 1 ppm  |            |
| Accuracy                              | ±30 ppm ±3% of measured value                        |            |
| Response Time                         | 120 sec  |            |
| Warm-up Time                          | 300 sec  |            |
| Life Time                             | 15 years   |            |
| <b>Temperature Measurement</b>        |  |            |
| Range                                 | -20 to +50°C   |            |
| Resolution                            | 0.1°C  |            |
| Accuracy                              | ±0.6°C   |            |
| <b>Relative Humidity Measurement</b>  |  |            |
| Range                                 | 0 to 100% RH, Non-condensing                         |            |
| Resolution                            | 0.1% RH, Non-condensing                              |            |



|                            |   |                           |       |
|----------------------------|---|---------------------------|-------|
| Accuracy                   | ±5% RH, Non-condensing  |                           |       |
| Life time                  | 10 years  |                           |       |
| <b>Dew Point</b>           |   |                           |       |
| Range                      | Calculated using temperature and relative humidity                              |                           |       |
| Resolution                 | 0.1°C   |                           |       |
| <b>System</b>              |   |                           |       |
| CO Alarm                   | Yes   |                           |       |
| CO <sub>2</sub> Alarm      | Yes   |                           |       |
| PM1/ PM 2.5/ PM 10 Alarm   | Yes   |                           |       |
| Real Time Clock            | Yes   |                           |       |
| Data Logger                | Yes, 180,000 Records  |                           |       |
| Alarm Relay Output         | PhotoMos Relay × 4, 100 VDC @ 1 A   |                           |       |
| <b>Communication</b>       |   |                           |       |
| RS-485 Port                | Baud Rate = 1200 ~ 115200 bps   |                           |       |
| Ethernet Port              | 10/100 Base-TX, 8-Pin RJ-45 x1(Auto-negotiating, Auto-MDI/MDIX, LED indicators) |                           |       |
| Security                   | IP filter (whitelist) and Password (web)  |                           |       |
| Protocol                   | Modbus/RTU(RS-485), Modbus TCP(Ethernet) and MQTT(Ethernet)                     |                           |       |
| Dual Watchdog              | Yes, Module (2.3 sec), Communication (Programmable)                             |                           |       |
| Wireless Interface         | -   | Wi-Fi                     |       |
| Standard Supported         | -   | IEEE 802.11 b/g/n         |       |
| Wireless Mode              | -   | Infrastructure/Limited AP |       |
| Wireless Security          | -   | WEP, WPA, WPA2            |       |
| Transmission Range         | -   | 50 m (LOS)                |       |
| <b>LED Indicators</b>      |   |                           |       |
| PWR                        | Green for normal operation  |                           |       |
| Link                       | Green for the Ethernet-linked   |                           |       |
| S1 ~ S4                    | Red for an alarm condition  |                           |       |
| <b>Electrical</b>          |   |                           |       |
| Powered via Terminal Block | +12 to +48 VDC  |                           |       |
| Powered via PoE            | IEEE 802.3af, Class 1 (require a PoE switch or injector)                        |                           |       |
| Power Consumption          | PoE   | 3.2 W                     | 3.4 W |
|                            | Non-PoE   | 3.0 W                     | 3.2 W |

| <b>Mechanical</b>      |                                   |
|------------------------|-----------------------------------|
| Dimensions (L x W x H) | 211 mm x 130 mm x 70 mm           |
| Installation           | Ceiling Mounting or Wall Mounting |
| <b>Environment</b>     |                                   |
| Operating Temperature  | -20 to +50°C                      |
| Storage Temperature    | -30 to +75°C                      |
| Humidity               | 10 to 90% RH, Non-condensing      |
| Protection Class       | IP43                              |

| <b>Model</b>                          | <b>DL-1038</b>                                       | <b>DL-1038-WF</b> |
|---------------------------------------|--|-------------------|
| <b>PM1 / PM2.5 / PM10 Measurement</b> |  |                   |
| Range                                 | 0 to 1,000µg/m <sup>3</sup> ( Laser Type)            |                   |
| Resolution                            | 1µg/m <sup>3</sup>                                   |                   |
| Accuracy                              | ± 10% of FSR   |                   |
| Response Time                         | 1 sec  |                   |
| Warm-up Time                          | 20 sec   |                   |
| Life time                             | 5 years, Customer has to replace the filter patch.   |                   |
| <b>Particle</b>                       |  |                   |
| Sizes                                 | 0.3µm, 0.5µm, 1µm, 2.5µm, 5µm, 10µm                  |                   |
| Life Time                             | 5 years, the filter patch (FLT-C001) by replaceable. |                   |
| <b>CO Measurement</b>                 |  |                   |
| Range                                 | 0 to 1000 ppm (Electrochemical)                      |                   |
| Resolution                            | 1 ppm  |                   |
| Accuracy                              | ±5% of measured value                                |                   |
| Response Time                         | 30 sec   |                   |
| Warm-up Time                          | 60 sec   |                   |
| Life Time                             | 5 years  |                   |
| <b>CO<sub>2</sub> Measurement</b>     |  |                   |
| Range                                 | 0 ~ 9999 ppm (NDIR)                                  |                   |
| Resolution                            | 1 ppm  |                   |
| Accuracy                              | ±30 ppm ±3% of measured value                        |                   |
| Response Time                         | 120 sec  |                   |

|                                      |   |
|--------------------------------------|---|
| Warm-up Time                         | 300 sec   |
| Life Time                            | 15 years  |
| <b>TVOC Measurement</b>              |   |
| Range                                | 0 to 60000 ppb (MEMS Metal Oxide)   |
| Resolution                           | 1 ppb   |
| Accuracy                             | ±15%  |
| Response Time                        | 60 seconds  |
| Warm-up Time                         | 180 seconds   |
| Life time                            | 5 years   |
| <b>Temperature Measurement</b>       |   |
| Range                                | -20 to +50°C  |
| Resolution                           | 0.1°C   |
| Accuracy                             | ±0.6°C  |
| <b>Relative Humidity Measurement</b> |   |
| Range                                | 0 to 100% RH, Non-condensing  |
| Resolution                           | 0.1% RH, Non-condensing   |
| Accuracy                             | ±5% RH, Non-condensing  |
| Life time                            | 10 years  |
| <b>Dew Point</b>                     |   |
| Range                                | Calculated using temperature and relative humidity                              |
| Resolution                           | 0.1°C   |
| <b>System</b>                        |   |
| CO Alarm                             | Yes   |
| CO <sub>2</sub> Alarm                | Yes   |
| TVOC Alarm                           | Yes   |
| PM1/ PM 2.5/ PM 10 Alarm             | Yes   |
| Real Time Clock                      | Yes   |
| Data Logger                          | Yes, 180,000 Records  |
| Alarm Relay Output                   | PhotoMos Relay × 4, 100 VDC @ 1 A   |
| <b>Communication</b>                 |   |
| RS-485 Port                          | Baud Rate = 1200 ~ 115200 bps   |
| Ethernet Port                        | 10/100 Base-TX, 8-Pin RJ-45 x1(Auto-negotiating, Auto-MDI/MDIX, LED indicators) |
| Security                             | IP filter (whitelist) and Password (web)  |

|                            |   |                           |       |
|----------------------------|---|---------------------------|-------|
| Protocol                   | Modbus/RTU(RS-485), Modbus TCP(Ethernet) and MQTT(Ethernet) |                           |       |
| Dual Watchdog              | Yes, Module (2.3 sec), Communication (Programmable)         |                           |       |
| Wireless Interface         | -   | Wi-Fi                     |       |
| Standard Supported         | -   | IEEE 802.11 b/g/n         |       |
| Wireless Mode              | -   | Infrastructure/Limited AP |       |
| Wireless Security          | -   | WEP, WPA ,WPA2            |       |
| Transmission Range         | -   | 50 m (LOS)                |       |
| <b>LED Indicators</b>      |   |                           |       |
| PWR                        | Green for normal operation                                  |                           |       |
| Link                       | Green for the Ethernet-linked                               |                           |       |
| S1 ~ S4                    | Red for an alarm condition                                  |                           |       |
| <b>Electrical</b>          |   |                           |       |
| Powered via Terminal Block | +12 to +48 VDC  |                           |       |
| Powered via PoE            | IEEE 802.3af, Class 1 (require a PoE switch or injector)    |                           |       |
| Power Consumption          | PoE   | 3.2 W                     | 3.4 W |
|                            | Non-PoE   | 3.0 W                     | 3.2 W |
| <b>Mechanical</b>          |   |                           |       |
| Dimensions (L x W x H)     | 211 mm x 130 mm x 70 mm                                     |                           |       |
| Installation               | Ceiling Mounting or Wall Mounting                           |                           |       |
| <b>Environment</b>         |   |                           |       |
| Operating Temperature      | -20 to +50°C  |                           |       |
| Storage Temperature        | -30 to +75°C  |                           |       |
| Humidity                   | 10 to 90% RH, Non-condensing                                |                           |       |
| Protection Class           | IP43  |                           |       |

## 2.2 Appearance

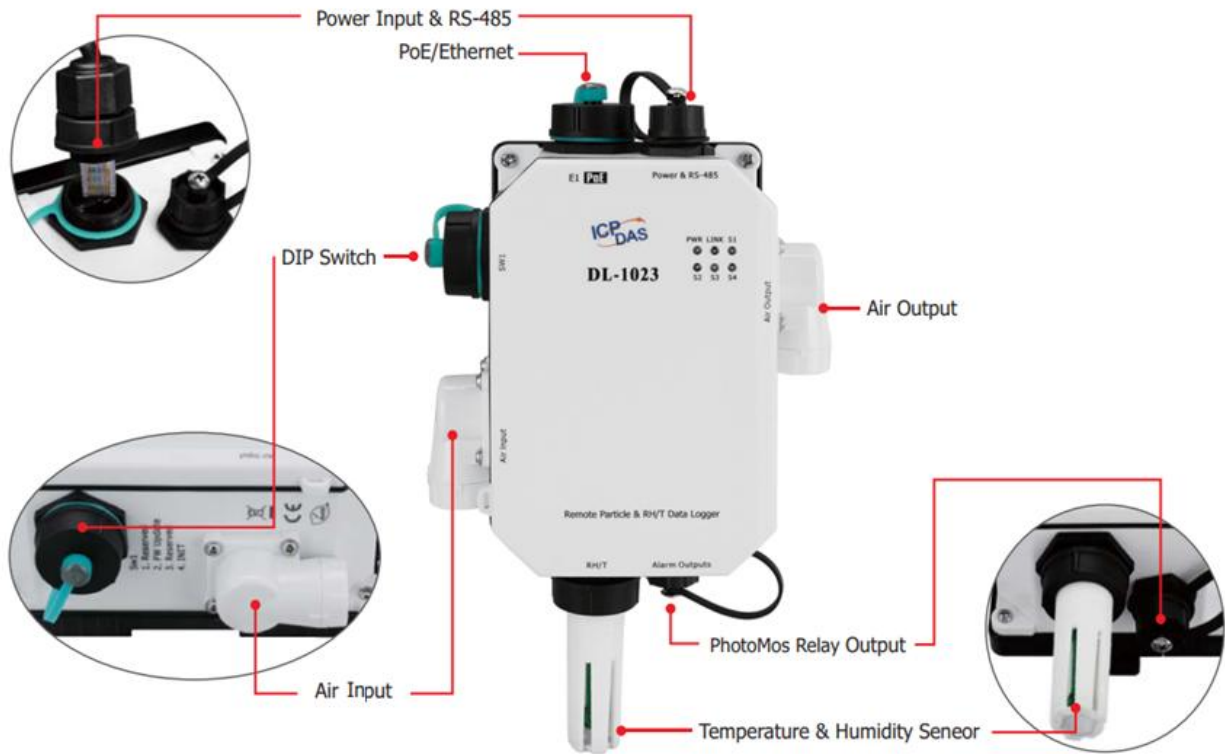

The three LED indicators from left to right are:

- ▶ PWR: green for normal operation.
- ▶ Link: green for the Ethernet linked.
- ▶ Alarm: red for alarm condition.

### DIP Switch



The functions are printed on the top beside the SW1 DIP switch. All the 4 dip switches need be turned to the off position for normal operation.

1. Reserved
2. FW Update: ON for updating firmware.
3. Reserved
4. INIT: ON for using the factory default settings for communication

### Dust Filter Hood

DL-1000 series equip with two filter hoods. In the back side of the hood. ICPDAS provide a customized patch for the hood. This special mechanism design is good for users to replace the patch only.



### PoE/ non-PoE Ethernet port

The Ethernet port can be used to connect to a PoE switch or a non-PoE switch.





**Installation procedure:**

To install the waterproof connector, follow the procedure described below.

**Step 1: Remove the RJ-45 Connector from the RJ-45 Cable**



**Step 2: Feed the end of the two core power cable through the Sealing Nut, Seal, Lock Nut, Clamp Ring and Gasket**

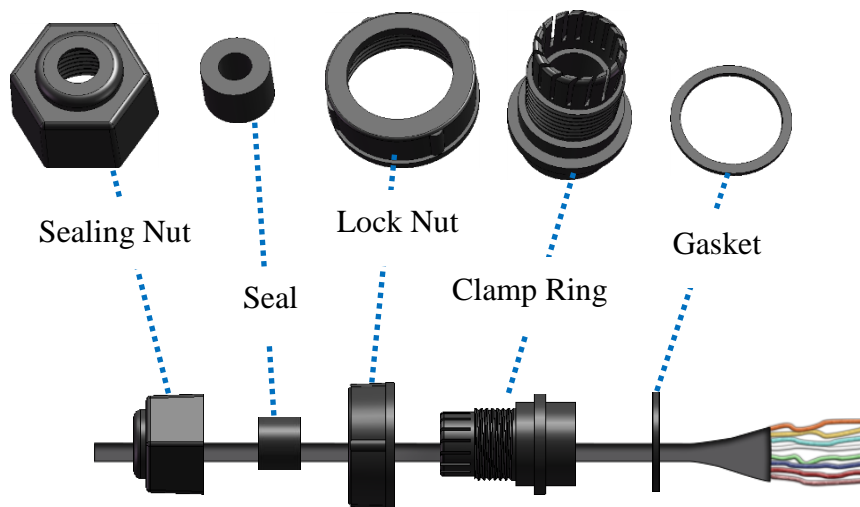

**Step 3: Wrap the Gasket around the Clamp Ring**

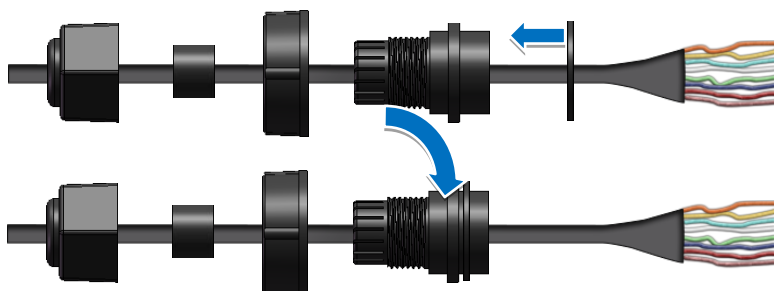

**Step 4: Wrap the Lock Nut around the Clamp Ring**

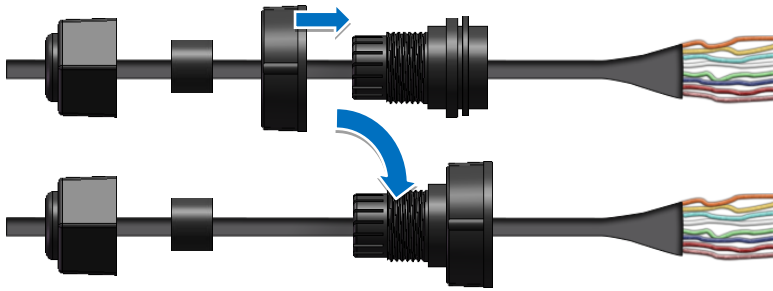

**Step 5: Insert the Seal around the Clamp Ring**

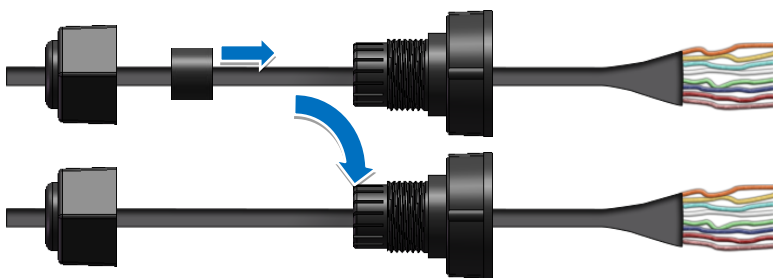

**Step 6: Push the Seal Nut forward and Hand-tighten it to seal the assembly**

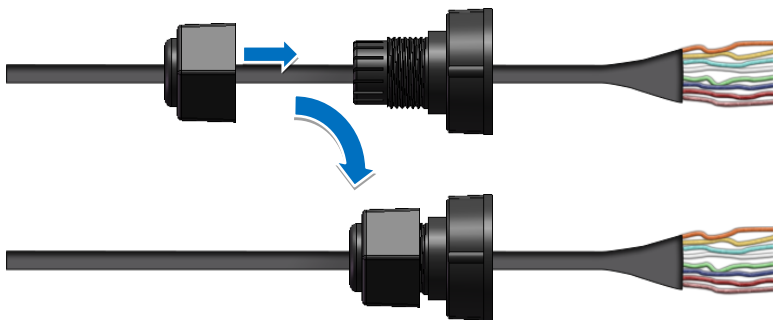

**Step 7: Insert the RJ-45 Cable into the RJ-45 Connector**

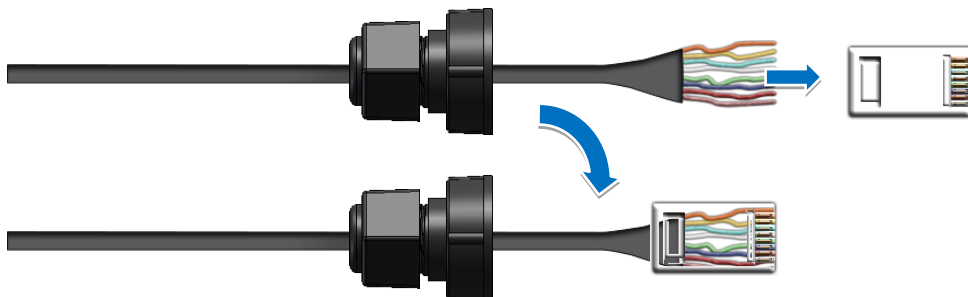



**Step 8:** Push the RJ-45 waterproof connector assembly forward so that it covers the RJ-45 connector



**Step 9:** Connect the RJ-45 Cable to the COM Port on the DL-1000-E module



Firmly tighten the connector to the module and ensure that it is completely connected.



### Connector for Power/ RS-485/ Alarm Relay Output

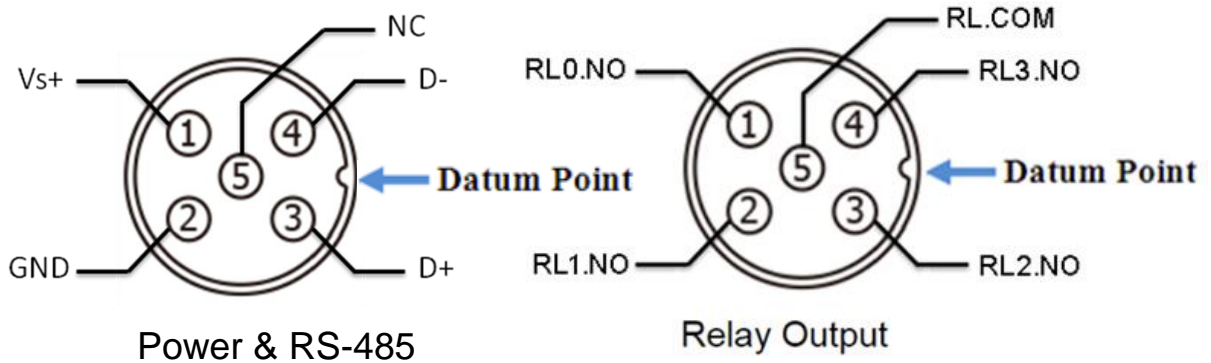

- Wire requirement:
- Stripping length: 8 ~ 10 mm
  - 0.20 - 1.5 mm<sup>2</sup> (IEC) / 28 - 16 AWG (UL)

**Step 1:** Feed the end of the two core power cable through the **Sealing nut, Seal, Clamp Ring, Gasket and Lock Nut**

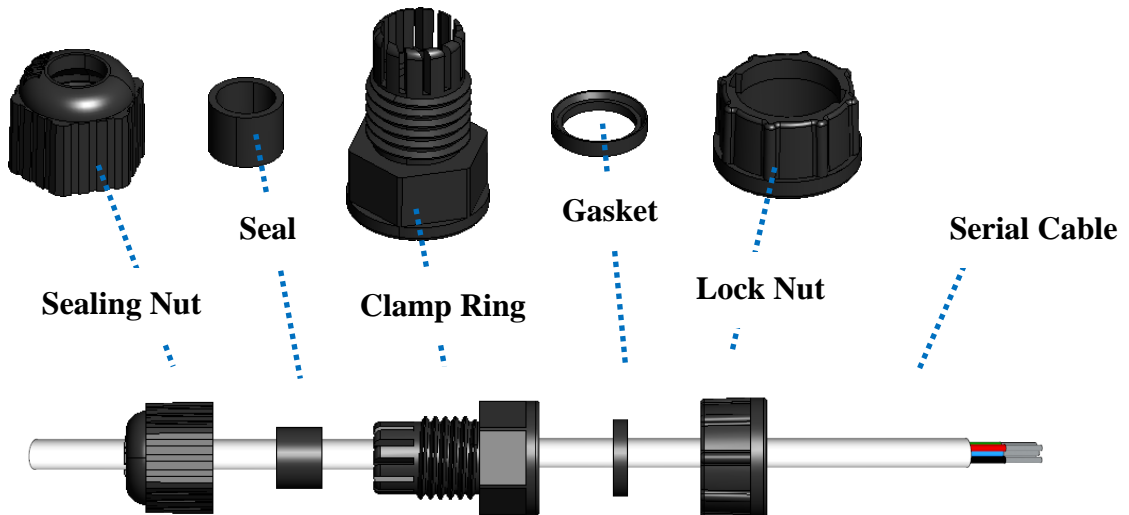

**Step 2:** Insert the conductors into the holes on the **5 Pin Cable Connector**. See the figure below for the correct pin-out connections

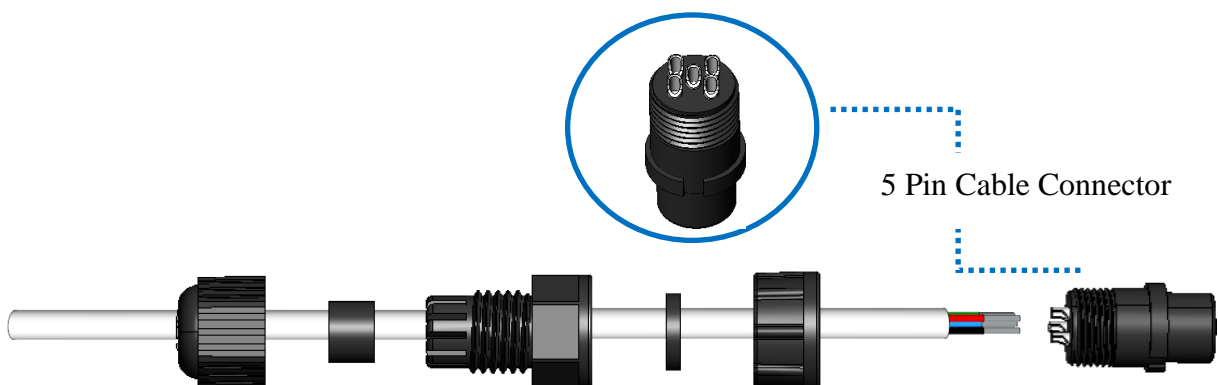

**Step 3: Wrap the Lock Nut around the 5 Pin Cable Connector**

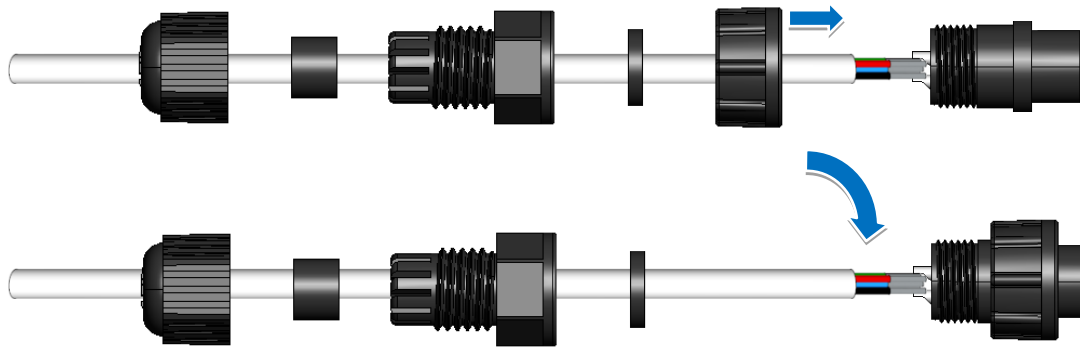

**Step 4: Insert the Gasket into the Clamping Ring**

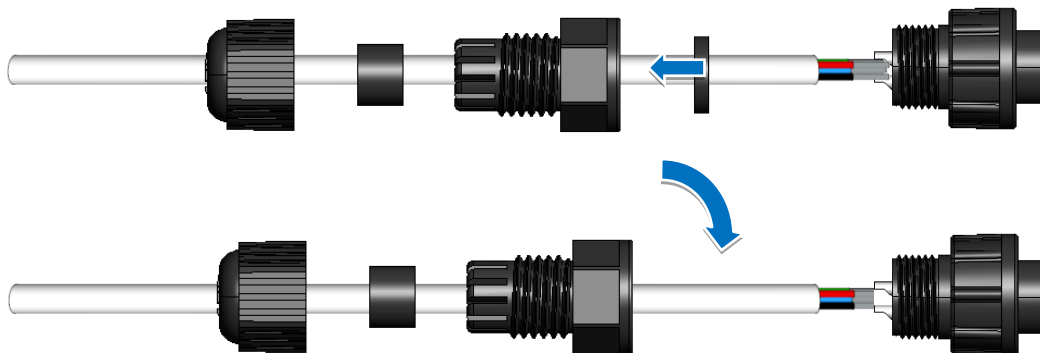

**Step 5: Wrap the Clamp Ring around the 5 Pin Cable Connector**

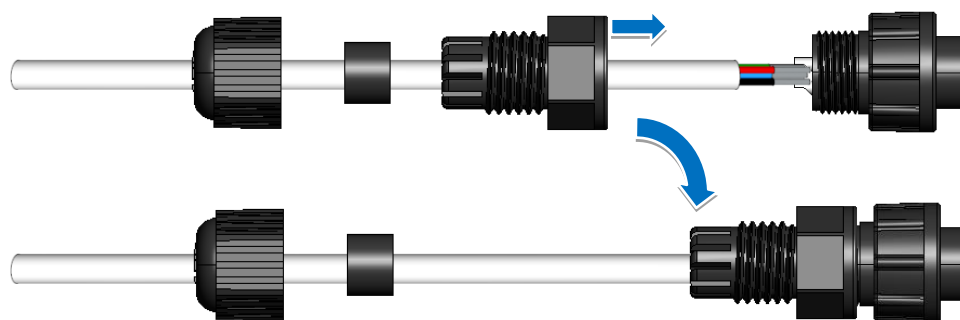

**Step 6: Insert the Seal into the Clamp Ring**

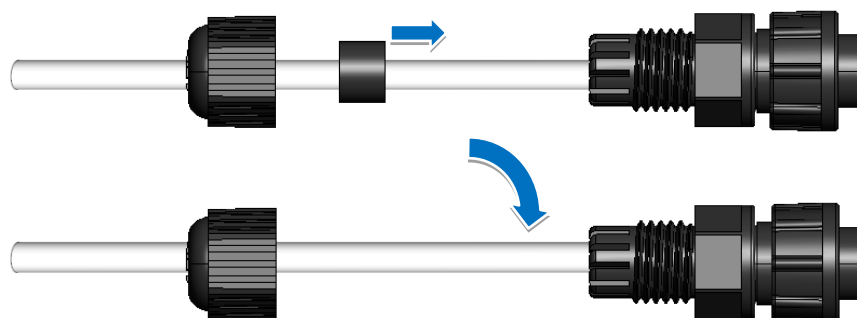

**Step 7:** Push the **Sealing Nut** forward and Hand-tighten it to seal the assembly

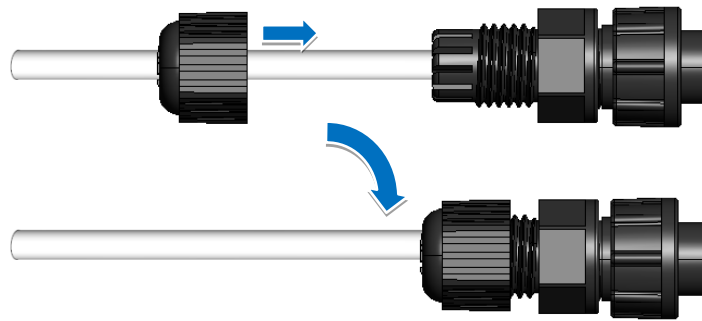

**Step 8:** Wrap the **O-Ring** around the **5 Pin Cable Connector**

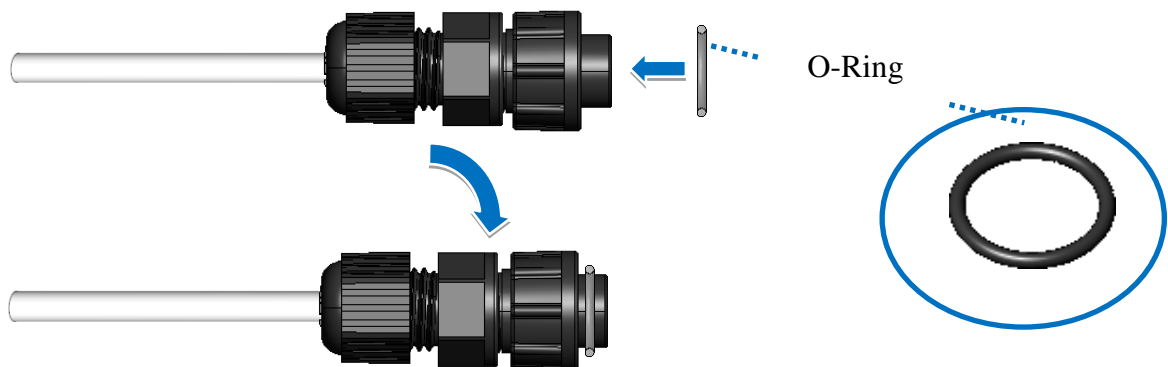

**Important:** Make sure to tighten firmly.

**Step 9:** Connect the Power cable to the Power socket on the DL-1000 module

The fool-proofing groove (as red circle) is useful for easy connection of power cable and power plug. Please make sure they are located in the same direction when connecting these two items.



### Relay Output Wire Connection

| Output Type  | ON State<br>Readback as 1 | OFF State<br>Readback as 0 |
|--------------|---------------------------|----------------------------|
| Relay Output |                           |                            |

## 2.3 Dimensions (unit: mm)

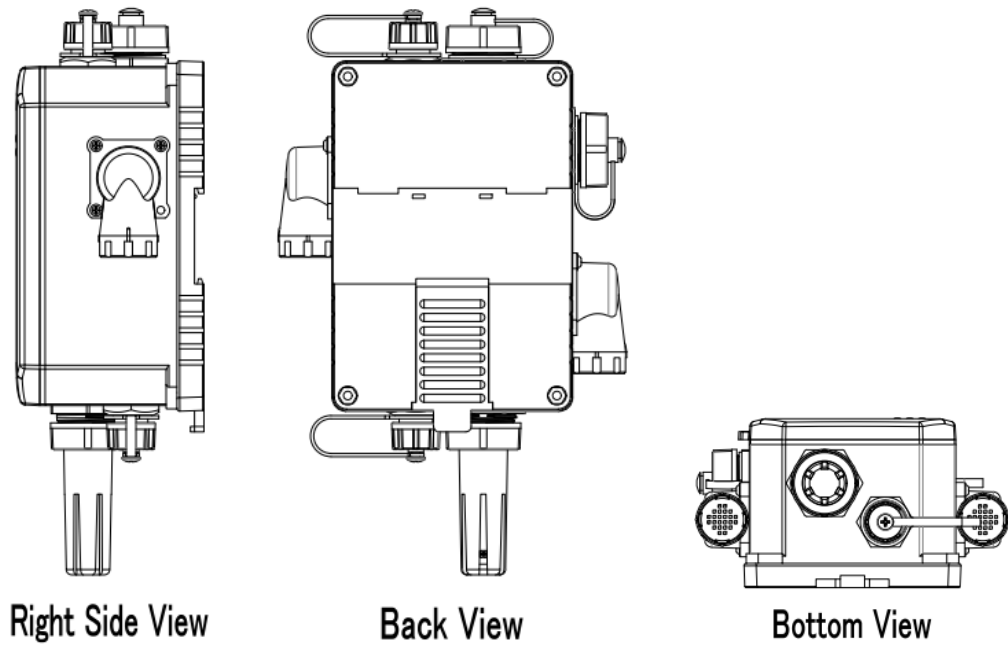
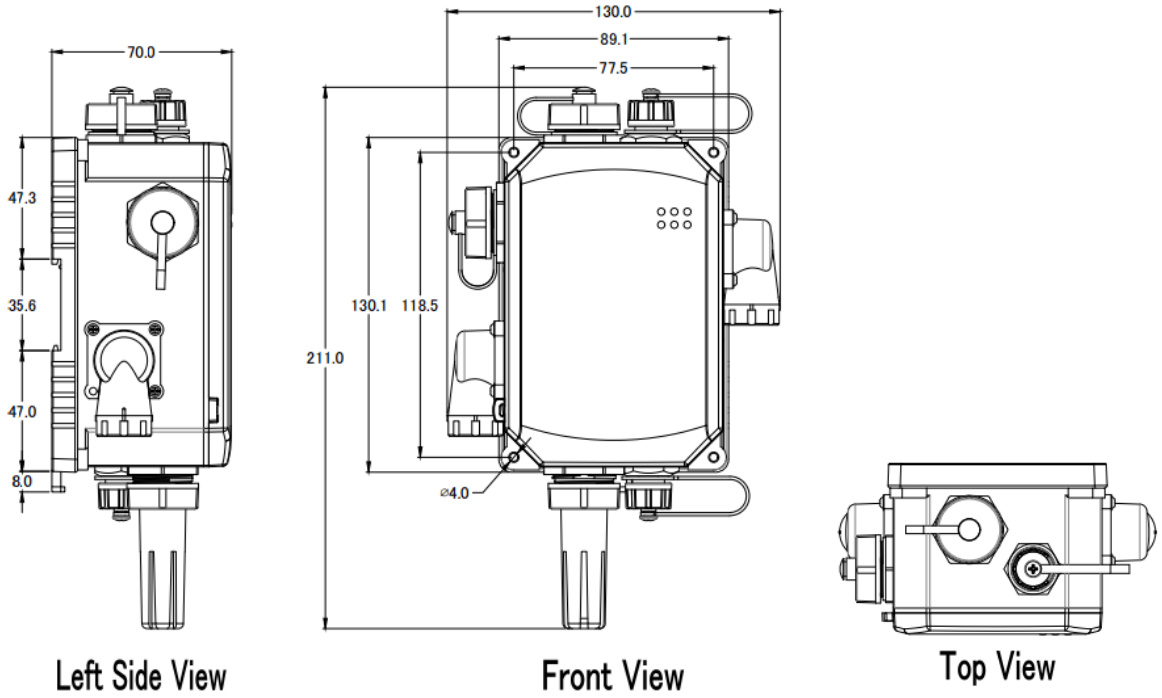

Unit: mm

## 2.4 Cabling for Power and Network

### Note

- Do not install the DL-1000 module near a vent, a ventilation fan or a door where the air flows faster. Also avoid putting the module on a desktop below the nose and mouth to prevent incorrect measurement.
- Avoid installing in locations where the temperature is below  $-20^{\circ}\text{C}$  or above  $80^{\circ}\text{C}$ .
- Avoid installing in locations near a strong electromagnetic field.

### For connecting with a PC or a Android device

The DL-1000 logger can connect to a PoE network without a power source or connect to a non-PoE network. When using the **Search** function in iAir App on Android or iOS mobile devices, mobile devices need to connect to the same subnet that the DL-1000 connected to over Wi-Fi. Similarly to using the Search function in DL-1000 Utility running on Windows, the module and the host PC need to connect on the same subnet, too.

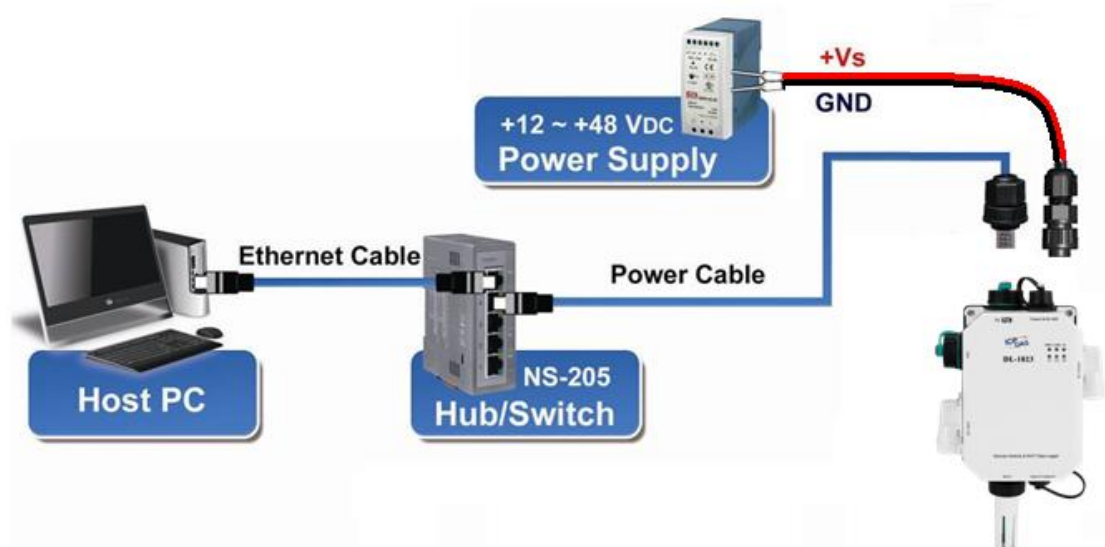
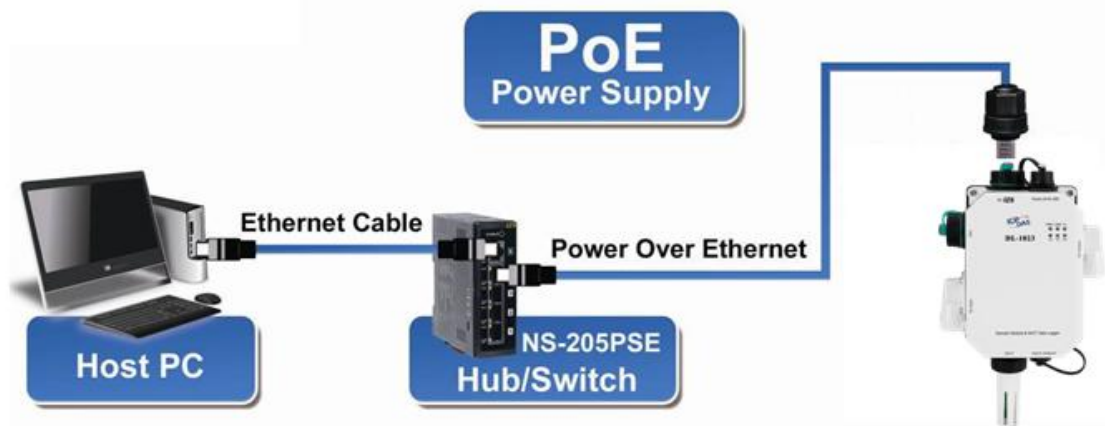

The iAir App and DL-300 Utility search the logger by broadcast, therefore only the devices on the same subnet can be searched out. It means that the host PC, Android devices and the logger must have the same broadcast address. The broadcast address for an IPv4 device can be obtained by performing a bitwise OR operation between the bit complement of the subnet mask and the IP address for a device. In other words, take the device's IP address, and set to '1' any bit positions which hold a '0' in the subnet mask.

For example, in an entire IPv4 subnet, the host PC or the Android device uses the private IP address space 172.16.0.0/12 and subnet mask address 255.240.0.0, the broadcast address is  $172.16.0.0 \mid 0.15.255.255 = 172.31.255.255$ . Only the loggers which have the same broadcast address could be searched out in the iAir App or DL-300 Utility. Please contact with your network administrator to make sure the DL-1000 logger is connected to the same sub-network that your Android devices or PC is connected to.

### For connecting with PC via RS-485 network

The DL-1000 logger can connect to the PC through a RS-485 network with power input requirement of +12 ~ +48 V<sub>DC</sub>.

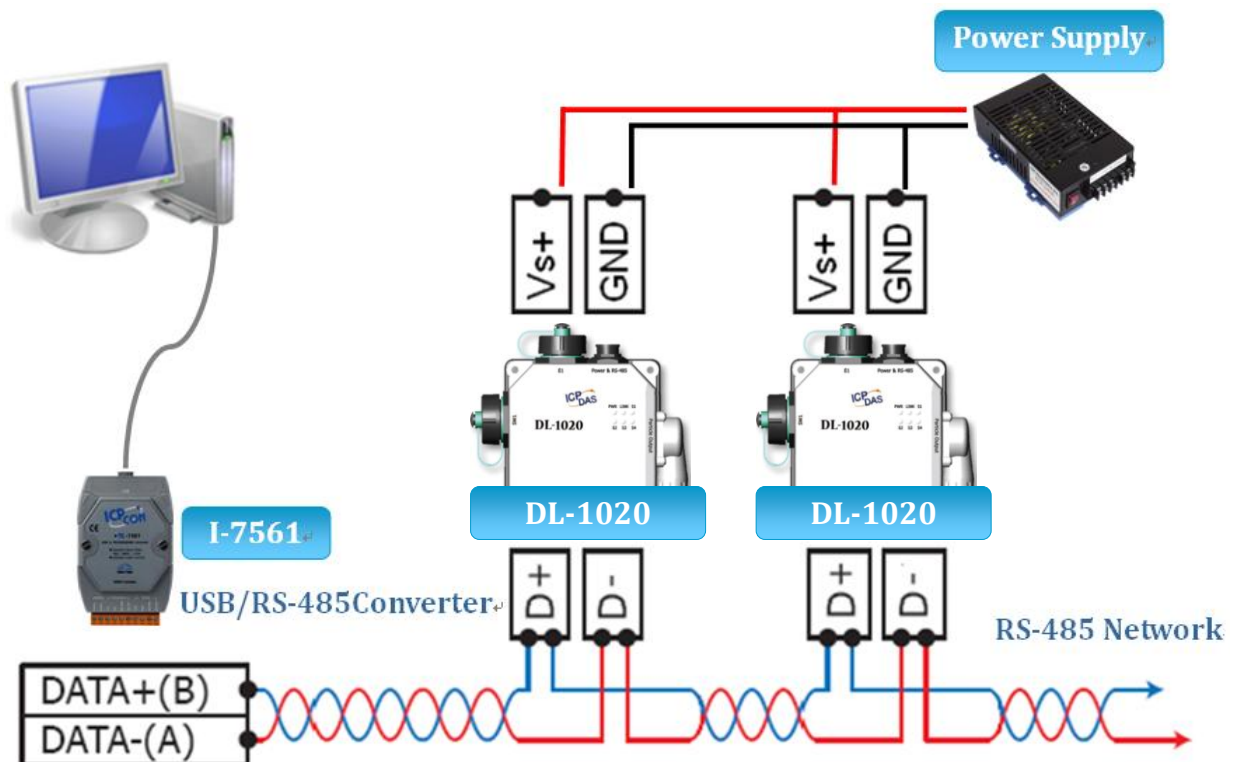

---

## 3. Configuration via Web Browser

DL-1000 logger has a built-in web server that provides simple web pages for remote monitoring real-time data and configuring the logger with a standard browser. For opening the web page in DL-1000, the factory default IP address (192.168.255.1), Subnet Mask (255.255.0.0) and Gateway (192.168.0.1) need be set to available IP/Subnet Mask/Gateway addresses in your Ethernet environment. The Ethernet configuration can be set by entering the Settings menu from the by web pages.

---

### 3.1 Search the DL-1000 logger

eSearch is designed to search out the DL-1000 logger connected on the same Ethernet network, it supports for Linux and Windows and is needless to install.

The eSearch can be downloaded from

CD:\Napdos\IIoT\utility\esearch

<http://ftp.icpdas.com/pub/cd/usbcd/napdos/iiot/utility/esearch/>

Before running eSearch, turn off firewall on computer, and connect the computer and DL-1000 logger to Ethernet network.

1. Launch eSearch, click the **Search Servers** button to search the DL-1000 modules connected to the network, the modules searched out will be listed as below.
2. Double click the module name searched in the list.

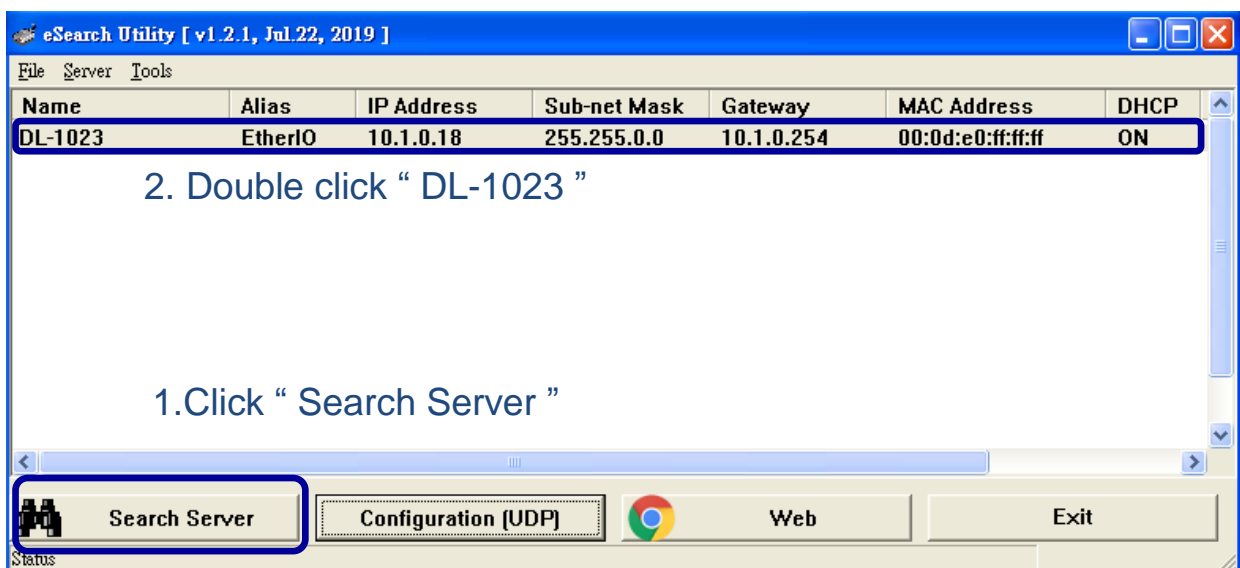



- Set available IP Address, Sub-net Mask, Gateway (designated by your network administrator) and alias and click the **OK** button.

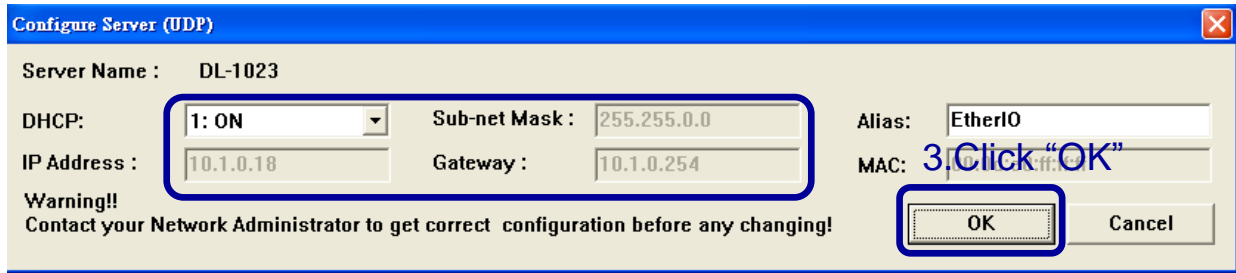

## 3.2 Logging into the DL-1000

- Enter the IP address for your DL-1000 in the address bar of a web browser. (sec. 3.1)
- Type the Login password, and click the **Submit** button.  
(The default Login password is **Admin**, case sensitive.)

1



### 3.3 Home

The first page displayed is **Home**, it shows the based configuration of the DL-1000 module and the real-time data as below:



**DL-1023 CO, CO<sub>2</sub>, Particulate Matter, Relative Humidity and Temperature Data Logger**

[Home](#) | [Network](#) | [MQTT](#) | [I/O Settings](#) | [Filter](#) | [Monitor](#) | [Change Password](#) | [Logout](#)

#### Status & Configuration

|                  |                      |   |                   |
|------------------|----------------------|---|-------------------|
| Model Name       | DL-1023              | Alias Name                                  | EtherIO           |
| Firmware Version | B4.5 [Feb. 18, 2019] | MAC Address                                 | 00-0D-E0-FF-FF-FF |
| IP Address       | 10.1.0.18            | TCP Port Timeout (Socket Watchdog, Seconds) | 180               |
| Initial Switch   | OFF                  | System Timeout (Network Watchdog, Seconds)  | 0                 |

#### Sensor Readings

| Type                          | Value                | Low Latched         | High Latched         |
|-------------------------------|----------------------|---------------------|----------------------|
| CO                            | 0 ppm                | 0 ppm               | 0 ppm                |
| CO <sub>2</sub>               | 754 ppm              | 722 ppm             | 792 ppm              |
| PM2.5                         | 9 ug/m <sup>3</sup>  | 3 ug/m <sup>3</sup> | 14 ug/m <sup>3</sup> |
| Relative Humidity             | 75.5%                | 74.9%               | 77.3%                |
| Temperature                   | 20.9 °C              | 20.8 °C             | 21.3 °C              |
| Dew Point                     | 16.4 °C              | 16.3 °C             | 16.9 °C              |
| PM1.0                         | 9 ug/m <sup>3</sup>  | 3 ug/m <sup>3</sup> | 12 ug/m <sup>3</sup> |
| PM10                          | 11 ug/m <sup>3</sup> | 5 ug/m <sup>3</sup> | 23 ug/m <sup>3</sup> |
| Particle Count (0.3 - 0.5um)  | 2282                 | 1047                | 3075                 |
| Particle Count (0.5 - 1.0um)  | 5864                 | 3870                | 7525                 |
| Particle Count (1.0 - 2.5um)  | 918                  | 423                 | 1765                 |
| Particle Count (2.5 - 5.0um)  | 5                    | 0                   | 51                   |
| Particle Count (5.0 - 7.5um)  | 0                    | 0                   | 90                   |
| Particle Count (7.5 - 10.0um) | 0                    | 0                   | 60                   |

Clear Low Latched

Clear High Latched

Copyright © 2017 ICP DAS Co., Ltd. All rights reserved.

In the **Sensor Readings** field is the real-time data of CO/CO<sub>2</sub> concentration, temperature, humidity and dew point, the minimum value (Low Latched) and maximum value (High Latched) logged. Clicking on the **Clear Low Latched** button and the **Clear High Latched** button can reset the latched data to current value and latch new minimum or maximum value.





**Alarm**

| Type                          | Alarm Mode | Low Alarm Limit | High Alarm Limit     | Low Alarm Status | High Alarm Status |
|-------------------------------|------------|-----------------|----------------------|------------------|-------------------|
| CO                            | Disabled   |                 | -1 ppm               |                  | Off               |
| CO <sub>2</sub>               | Disabled   |                 | -1 ppm               |                  | Off               |
| PM2.5                         | Disabled   |                 | -1 ug/m <sup>3</sup> |                  | Off               |
| Relative Humidity             | Disabled   | 0.0%            | 0.0%                 | Off              | Off               |
| Temperature                   | Disabled   | -0.0 °C         | -0.0 °C              | Off              | Off               |
| Dew Point                     | Disabled   | -0.0 °C         | -0.0 °C              | Off              | Off               |
| PM1.0                         | Disabled   |                 | -1 ug/m <sup>3</sup> |                  | Off               |
| PM10                          | Disabled   |                 | -1 ug/m <sup>3</sup> |                  | Off               |
| Particle Count (0.3 - 0.5um)  | Disabled   |                 | -1                   |                  | Off               |
| Particle Count (0.5 - 1.0um)  | Disabled   |                 | -1                   |                  | Off               |
| Particle Count (1.0 - 2.5um)  | Disabled   |                 | -1                   |                  | Off               |
| Particle Count (2.5 - 5.0um)  | Disabled   |                 | -1                   |                  | Off               |
| Particle Count (5.0 - 7.5um)  | Disabled   |                 | -1                   |                  | Off               |
| Particle Count (7.5 - 10.0um) | Disabled   |                 | -1                   |                  | Off               |

Clear Latched Alarm

The Alarm table displays the settings of alarm mode, high alarm limit for CO/CO<sub>2</sub> concentration, temperature, humidity and dew point, low alarm limit for temperature, humidity and dew point, and the alarm status for each. Clicking on the **Clear Latched Alarm** button can clear the activated alarm status.

**Digital Output**

|     |   |  |
|-----|---|--|
| DO0 |  |  |
| DO1 |  |  |
| DO2 |  |  |
| DO3 |  |  |

The **Digital Output** table shows the status of the relay output and the control button **Set Digital Output** to change the relay output status. The control function is invalid when any of the alarm modes is not disabled. If one of the alarm modes is enabled, the relay is linked to the alarm status for tapping audible/visual alarm.

At the end of the page are the data, time and device online time since powered on.

**RTC**

|      |            |      |          |
|------|------------|------|----------|
| Date | 2019-12-24 | Time | 14:43:58 |
|------|------------|------|----------|

**Device Online Time**

|                    |                     |
|--------------------|---------------------|
| Device Online Time | 0 Days, 03H:14M:49S |
|--------------------|---------------------|

### 3.4 Network

The networks parameters are set on this page including DHCP enabled/disabled, IP/Subnet Mask/Gateway addresses, the port number and the NetID for Modbus TCP communication. Remember to click on the **Update Settings** button to update new parameters.

#### IP Address Configuration

| IP Address            |   |
|-----------------------|---|
| Address Type          | DHCP ▾  |
| Static IP Address     | 255 . 255 . 255 . 255                         |
| Subnet Mask           | 0 . 0 . 0 . 0                                 |
| Default Gateway       | 0 . 0 . 0 . 0                                 |
| MAC Address           | 00-0D-E0-FF-FF-FF (Format: FF-FF-FF-FF-FF-FF) |
| Modbus TCP Slave      |   |
| Local Modbus TCP port | 502 (Default= 502)                            |
| Local Modbus NetID    | 1 (Default= 1) Enable ▾ (Default= Enable)     |
| Update Settings       |   |

#### General Settings

|                                   |  |
|-----------------------------------|--|
| Ethernet Speed                    | Auto ▾ (Auto=10/100 Mbps Auto-negotiation)                       |
| System Timeout (Network Watchdog) | 0 (30 ~ 65535 s, Default= 0, Disable= 0) Action:Reboot           |
| TCP Timeout                       | 180 (5 ~ 65535 s, Default= 180, Disable= 0) Action:Cut-off       |
| UDP Configuration                 | Enable ▾ (Enable/Disable the UDP Configuration, Enable=default.) |
| Web Auto-logout                   | 10 (1 ~ 65535 minutes, Default= 10, Disable= 0)                  |
| Alias Name                        | EtherIO (Max. 30 chars, part of the MQTT topic name)             |
| Update Settings                   |  |

| Item                              | Description   | Default        |
|-----------------------------------|---|----------------|
| System Timeout (Network Watchdog) | Sets the timeout for rebooting a DL-1000 logger when it is abnormal or failure to communicate.<br><br>Range: 30 ~ 65535 (unit: second)<br>0 = Disable                         | 0<br>(Disable) |
| TCP Timeout                       | Sets the timeout for disconnecting a TCP connection when a DL-1000 does not receive data coming from the Ethernet port.<br><br>Range: 5 ~ 65535 (unit: second)<br>0 = Disable | 180            |

|                 |   |         |
|-----------------|---|---------|
| Web Auto-logout | Sets the timeout for logout the web server in a logger when there is no any operation from the web browser interface.<br><br>Range: 1 ~ 65535 (unit: minute)<br>0 = Disable | 10      |
| Alias Name      | Sets an alias name for easy to identify a DL-1000. The maximum length is 18 characters.   | EtherIO |

### Restore Factory Defaults

|   |                  |
|---|------------------|
| Restore all options to their factory default states | Restore Defaults |
|---|------------------|

|               |        |
|---------------|--------|
| Forced Reboot | Reboot |
|---------------|--------|

The **Reboot** button is used to reboot the DL-1000. After pressing the button, a user needs to login the DL-1000 logger again to using the web interface.

The **Restore Defaults** button can be used to restore the following settings to factory default values.

| Item             | Factory Default     |
|------------------|---------------------|
| IP address type  | Static IP           |
| Static IP        | 192.168.255.1       |
| Default gateway  | 192.168.0.1         |
| Subnet Mask      | 255.255.0.0         |
| MAC address      | Factory MAC address |
| Modbus TCP port  | 502                 |
| Modbus TCP NetID | 1                   |
| Modbus TCP NetID | Enabled             |
| System Timeout   | 0 (disabled)        |
| TCP Timeout      | 180 seconds         |
| Web auto logout  | 10 minutes          |
| Alias name       | EtherIO             |
| Accessible IP    | Disabled            |

### Firmware Update

|  |        |
|--|--------|
| If the remote firmware update is failed, then the traditional firmware update (on-site) is required to make the module working again.<br>Step 1: Refer to firmware update manual first.<br>Step 2: Run eSearch Utility to prepare and wait for update.<br>Step 3: Click the [Update] button to <b>reboot</b> the module and start update.<br>Step 4: Configure the module again. | Update |
|--|--------|

The Update button is used to update firmware for DL-1000 version. For details regarding firmware update, please refer to the section 8. FAQ Q11.

### 3.5 MQTT

---

MQTT stands for MQ Telemetry Transport, it is a publish/subscribe, extremely simple and lightweight messaging protocol, designed for constrained devices and low-bandwidth, high-latency or unreliable networks.

The Publish-Subscribe messaging pattern requires a message broker. The broker is responsible for distributing messages to interested clients based on the topic of a message. Now the MQTT Version 3.1.1 becomes an OASIS standard, it is an ideal protocol for communicating with connected devices in the emerging "machine-to-machine" (M2M) and "Internet of Things" applications, and for mobile applications where bandwidth and battery power are at a premium.

#### Connectivity Settings

|  |  |
|--|--|
| MQTT   | Disable ▾  |
| Broker   | <input checked="" type="radio"/> IP <input type="text" value="255"/> . <input type="text" value="255"/> . <input type="text" value="255"/> . <input type="text" value="255"/><br><input type="radio"/> Host Name |
| Broker Port                                    | <input type="text" value="-1"/> (Default= 1883)  |
| Client Identifier                              | <input type="text" value="DL-1023_FFFFFFF"/>   |
| Alias Name                                     | <input type="text" value="EtherIO"/> (Max. 30 chars, part of the topic name)   |
| User Name                                      | <input type="text"/> (Max. 63 chars)   |
| Password                                       | <input type="text"/> (Max. 63 chars)   |
| Reconnection Interval                          | <input type="text" value="4294967"/> (5 ~ 65535 s, Default= 10)  |
| Keep Alive Interval                            | <input type="text" value="4294967"/> (5 ~ 65535 s, Default= 20)  |
| <input type="button" value="Update Settings"/> |  |

Input the IP address and port number for the MQTT broker and click on the **Update Settings** button to save the parameters. For RevB version or firmware version B3.9 and later, the MQTT function can be disabled and there are more settings for user name, password, reconnection interval and keep alive interval.

## Last Will Settings

|  |                                      |
|--|--------------------------------------|
| Last Will and Testament                        | <input type="checkbox"/>             |
| Topic  | <input type="text"/> (Max. 30 chars) |
| Message  | <input type="text"/> (Max. 30 chars) |
| QoS  | 0 - At most once ▾                   |
| Retained                                       | <input type="checkbox"/>             |
| <input type="button" value="Update Settings"/> |                                      |

The last will settings are only available to the RevB version or firmware version B3.9 and later. The MQTT Last Will and Testament (LWT) feature is used to notify other clients about an ungracefully disconnected client. A DL-1000 module can register an offline message (LWT) to the broker. The LWT message will be delivered to all clients who subscribe to the offline topic if the DL-1000 module disconnects unexpectedly.

- Last Will and Testament: Tick the option to enable the last will and testament function.
- Topic: The topic name of the last will.
- Message: The message of the last will.
- QoS: The QoS of the last will message.
- Retained: Tick the option such that the will message is to be retained when it is published.

## Publication Settings

|  |     |  |
|--|-----|--|
| Cycle  | -10 | (400 ~ 65500 ms, in 10 ms step, Default= 1000) |
| Module Topic Name                              | N/A | (Max. 255 chars)                               |
| CO Sub Topic Name                              | N/A | (Max. 63 chars) Enable ▾                       |
| CO <sub>2</sub> Sub Topic Name                 | N/A | (Max. 63 chars) Enable ▾                       |
| PM2.5 Sub Topic Name                           | N/A | (Max. 63 chars) Enable ▾                       |
| Relative Humidity Sub Topic Name               | N/A | (Max. 63 chars) Enable ▾                       |
| Temperature (°C) Sub Topic Name                | N/A | (Max. 63 chars) Enable ▾                       |
| Temperature (°F) Sub Topic Name                | N/A | (Max. 63 chars) Enable ▾                       |
| Dew Point (°C) Sub Topic Name                  | N/A | (Max. 63 chars) Enable ▾                       |
| Dew Point (°F) Sub Topic Name                  | N/A | (Max. 63 chars) Enable ▾                       |
| PM1.0 Sub Topic Name                           | N/A | (Max. 63 chars) Enable ▾                       |
| PM10 Sub Topic Name                            | N/A | (Max. 63 chars) Enable ▾                       |
| Particle Count (0.3 - 0.5um) Sub Topic Name    | N/A | (Max. 63 chars) Enable ▾                       |
| Particle Count (0.5 - 1.0um) Sub Topic Name    | N/A | (Max. 63 chars) Enable ▾                       |
| Particle Count (1.0 - 2.5um) Sub Topic Name    | N/A | (Max. 63 chars) Enable ▾                       |
| Particle Count (2.5 - 5.0um) Sub Topic Name    | N/A | (Max. 63 chars) Enable ▾                       |
| Particle Count (5.0 - 7.5um) Sub Topic Name    | N/A | (Max. 63 chars) Enable ▾                       |
| Particle Count (7.5 - 10.0um) Sub Topic Name   | N/A | (Max. 63 chars) Enable ▾                       |
| All Information Sub Topic Name                 | N/A | (Max. 63 chars) Enable ▾                       |
| <input type="button" value="Update Settings"/> |     |  |

- Cycle: sets the time period for update the publish messages in millisecond.
- Publication Topic Format: **This is only available to the RevB version or firmware version B3.9 and later.** The format of the publication topic can be either (Module Topic Name)(Sub Topic Name) or (Alias Name)/GetValue/(Sub Topic Name). The default format is (Module Topic Name)(Sub Topic Name).
- Module Topic Name: sets the module topic name.
- CO/ CO2/ PM2.5/ Relative Humidity/ Temperature (°C)/ Temperature (°F)/ Dew Point (°C)/ Dew Point (°F) PM1/ PM10/ Particle Count (0.3 – 10.0um) Sub Topic Name: sets the sub topic name for each item.
- All Information Sub Topic Name: **This is only available to the RevB version or firmware version B3.9 and later.** The sub-topic name of the publication topic of all information. Following is a sample all information topic:

```
{
"ModuleName":"DL-1022",
"MacAddress":"000DE0FFFFFD",
"CO2":"700",
"Humidity":"59.2",
" TemperatureC ":"17.1"
" TemperatureF ":"62.8",
"DewPointC":"11.9",
" DewPointF ":"53.4",
"AlarmStatus":"Off"
}
```

A MQTT client subscribes the messages form a MQTT broker by specifying the topic name as

### **Module Topic Name + Sub Topic Name**

For example, to subscribe the CO<sub>2</sub> level in this case, a MQTT client subscribes the topic name from a MQTT broker as

### **EtherIO/CO2**

Besides, for RevB version or firmware version B3.9 and later, the publication topic name can be



## Alias Name/GetValue/Sub Topic Name

For example, to subscribe the CO<sub>2</sub> level in this case, a MQTT client subscribes the topic name from a MQTT broker as

## EtherIO/GetValue/CO2

### Subscription Settings

|  |                                  |                 |
|--|----------------------------------|-----------------|
| DO0 Sub Topic Name                             | <input type="text" value="N/A"/> | (Max. 63 chars) |
| DO1 Sub Topic Name                             | <input type="text" value="N/A"/> | (Max. 63 chars) |
| DO2 Sub Topic Name                             | <input type="text" value="N/A"/> | (Max. 63 chars) |
| DO3 Sub Topic Name                             | <input type="text" value="N/A"/> | (Max. 63 chars) |
| <input type="button" value="Update Settings"/> |                                  |                 |

Input the Message Attribute Sub Topic Name and Message Sub Topic Name, and then click on the **Update Settings** button to save the parameters. Users can remotely display message or set the message attribute by publishing MQTT messages to the topic name of [Module Topic Name + Message Sub Topic Name] or [Module Topic Name + Message Attribute Sub Topic Name]

## 3.6 I/O Settings

---

### Temperature

|  |      |
|--|------|
| Scale  | °C ▼ |
| <input type="button" value="Update Settings"/> |      |

Users can change the temperature unit to Fahrenheit or Celsius in this field.

### CO<sub>2</sub> Automatic Baseline Correction

|  |            |
|--|------------|
| Mode   | Disabled ▼ |
| <input type="button" value="Update Settings"/> |            |

To Enable/Disable the CO<sub>2</sub> Automatic Baseline Correction function. It is supported on the DL-1022 and DL-1023 only.

## Q & A

---

### Q: What is ABC (Automatic Baseline Correction)?

A: ABC stands for the Automatic Baseline Correction which is used to adjust a shifted baseline to the carbon dioxide level in fresh air. In case of normal indoor application, the carbon dioxide level drops to nearly outside air where there are no human, green plants or anything to elevate the carbon dioxide levels on weekday evenings or weekends, the ABC algorithm constantly keeps track of the lowest reading and slowly corrects it as the expected value in fresh air typically around 400 ppm.

### Q: Why I need to enable the ABC?

A: When the CO<sub>2</sub> concentration detected in a period time of unoccupied space is greater than the base value of 400ppm, enable the ABC function to adjust the baseline. Be careful that the ABC will not work if a space is constantly occupied such as a hospital, 24-hr factory, 24-hr store, green house or other applications where CO<sub>2</sub> levels may be elevated at all times.

---

## Offset

|                            |     |  |
|----------------------------|-----|--|
| CO (ppm)                   | -1  |  |
| CO <sub>2</sub> (ppm)      | -1  |  |
| TVOC (ppb)                 | -1  |  |
| PM2.5 (ug/m <sup>3</sup> ) | -1  |  |
| Relative Humidity (%)      | 0.0 |  |
| Temperature (°C)           | 0.0 |  |
| PM1.0 (ug/m <sup>3</sup> ) | -1  |  |
| PM10 (ug/m <sup>3</sup> )  | -1  |  |
| Update Settings            |     |  |

Adjust the CO/CO<sub>2</sub>/PM2.5/PM1.0/PM10/humidity/temperature offset.

All the settings take effect after clicking the *Update Settings* button.

Besides, for RevB version or firmware version B4.8 and later, the publication topic name can be

## Alarm Configuration

| Type                          | Alarm Mode   | Low Alarm Limit | High Alarm Limit | Beep On Alarm |
|-------------------------------|--|-----------------|------------------|---------------|
| CO                            | Disabled ▼   |                 | -1               | Enabled ▼     |
| CO <sub>2</sub>               | Disabled ▼   |                 | -1               | Enabled ▼     |
| PM2.5                         | Disabled ▼   |                 | -1               | Enabled ▼     |
| Relative Humidity             | Disabled ▼   | 0.0             | 0.0              | Enabled ▼     |
| Temperature                   | Disabled ▼   | 0.0             | 0.0              | Enabled ▼     |
| Dew Point                     | Disabled ▼   | 0.0             | 0.0              | Enabled ▼     |
| PM1.0                         | Disabled ▼   |                 | -1               | Enabled ▼     |
| PM10                          | Disabled ▼   |                 | -1               | Enabled ▼     |
| Particle Count (0.3 - 0.5um)  | Disabled ▼   |                 | -1               | Enabled ▼     |
| Particle Count (0.5 - 1.0um)  | Disabled ▼   |                 | -1               | Enabled ▼     |
| Particle Count (1.0 - 2.5um)  | Disabled ▼   |                 | -1               | Enabled ▼     |
| Particle Count (2.5 - 5.0um)  | Disabled ▼   |                 | -1               | Enabled ▼     |
| Particle Count (5.0 - 7.5um)  | Disabled ▼   |                 | -1               | Enabled ▼     |
| Particle Count (7.5 - 10.0um) | Disabled ▼   |                 | -1               | Enabled ▼     |
| Beep On Alarm Time            | -1 (0: beep off, 1 to 250: beep on alarm time in seconds, 251: beep on alarm continuously) |                 |                  |               |
| Update Settings               |  |                 |                  |               |

All the settings take effect after clicking the *Update Settings* button.

| Item                                      | Description  | Default  |
|---|--|----------|
| Alarm Mode                                | <p><b>- Disabled:</b><br/>Disables alarm function.</p> <p><b>- Momentary:</b><br/>If a measurement value higher than the High Alarm Limit or lower than the Low Alarm Limit, the alarm occurs until the measurement value is within a range from Low Alarm Limit to High Alarm Limit. (For CO/CO<sub>2</sub> level, until the measurement value is lower than the High Alarm Limit.)<br/>The Alarm LED turns red, and the relay turns to on for every alarm event, and a sound alarm beeps as the setting in <i>Beep on Alarm Time</i> for CO/CO<sub>2</sub> high limit alarm events during the alarm stage.</p> <p><b>- Latched:</b><br/>If a measurement value higher than the High Alarm Limit or lower than the Low Alarm Limit, the alarm occurs. The Alarm LED turns red, the relay turns to on for every alarm event, and a sound alarm beeps as the setting in <i>Beep on Alarm Time</i> for CO/CO<sub>2</sub> high limit alarm events.<br/>Even though the alarm event is not presented, the alarm status is latched; the Alarm LED keeps red, and the relay keeps on and the sound alarm keeps beeping if it is set to beeping continuously.</p> | Disabled |
| Low Alarm Limit                           | Sets the Low alarm limit conditions for Relative Humidity/ Temperature/ Dew Point.   |          |
| High Alarm Limit                          | Sets the High alarm limit conditions for CO/CO <sub>2</sub> /Relative Humidity/ Temperature/ Dew Point.  |          |
| Beep On CO And CO <sub>2</sub> Alarm Time | <p>Sets the time for beeping alarm. It is valid when the high limit alarm for CO/CO<sub>2</sub> occurs.</p> <p>Range: 1 ~ 250 (unit: second)<br/>0 = disable the beeping alarm<br/>251 = continue the beeping alarm without stop</p>   | 251      |

### Digital Output

| Channel                         | Power On Value                                 | Safe Value |
|---------------------------------|--|------------|
| D00                             | On ▼   | Off ▼      |
| D01                             | On ▼   | Off ▼      |
| D02                             | On ▼   | Off ▼      |
| D03                             | On ▼   | Off ▼      |
| Host Watchdog Timeout (seconds) | 0 (5 to 65535 Seconds, Default= 0, Disable= 0) |            |
| Update Settings                 |  |            |

Set the *Power On Value* and *Safe Value* for the relay output, and the *Host Watchdog Timeout* timer for RS-485 communication; if a host does not send a command over the setting time, the Host Watchdog timeout occurs and the relay outputs the status set for Safe value. The settings for Power On Value and Safe Value are unavailable when any one setting in the *Alarm Mode* is enabled.

### RTC

|                 |      |                |
|-----------------|------|----------------|
| Year            | 2019 | (2000 to 2159) |
| Month           | 12   | (1 to 12)      |
| Date            | 24   | (1 to 31)      |
| Hour            | 15   | (0 to 23)      |
| Minute          | 20   | (0 to 59)      |
| Second          | 58   | (0 to 59)      |
| Update Settings |      |                |

All the settings take effect after clicking the *Update Settings* button.

### Data Logger

| Status                     | Error  |                |
|----------------------------|--------|----------------|
| Change Logging             | Stop ▼ |                |
| Overwrite on Full          | No ▼   |                |
| Sampling Interval - Hour   | 0      | (0 to 24)      |
| Sampling Interval - Minute | 0      | (0 to 59)      |
| Sampling Interval - Second | 10     | (0 to 59)      |
| Period Start - Year        | 2019   | (2000 to 2159) |
| Period Start - Month       | 6      | (1 to 12)      |
| Period Start - Date        | 1      | (1 to 31)      |
| Period Start - Hour        | 0      | (0 to 23)      |
| Period Start - Minute      | 0      | (0 to 59)      |
| Period Start - Second      | 0      | (0 to 59)      |
| Period End - Year          | 2019   | (2000 to 2159) |
| Period End - Month         | 6      | (1 to 12)      |
| Period End - Date          | 2      | (1 to 31)      |
| Period End - Hour          | 0      | (0 to 23)      |
| Period End - Minute        | 0      | (0 to 59)      |
| Period End - Second        | 0      | (0 to 59)      |
| Update Settings            |        |                |

In this table it shows the settings for data logger.

All the settings take effect after clicking the *Update Settings* button.

| Item              | Description   | Default |
|-------------------|---|---------|
| Status            | <ul style="list-style-type: none"> <li>- Running: the data logger is running</li> <li>- Stopped: the data logger is stopped</li> </ul>  |         |
| Change Logging    | Sets the mode for data logger <ul style="list-style-type: none"> <li>- Stop: stops the data logger</li> <li>- Run: continues logging data</li> <li>- Period: logs data in the specified period time</li> </ul>  | Stop    |
| Overwrite on Full | Sets whether to overwrite old data by new ones when the memory for data storage is full. (Over the upper limit of 450,000.) <ul style="list-style-type: none"> <li>- No: discards the new data (default)</li> <li>- Yes: overwrites the old data by new ones</li> </ul>   | No      |
| Sampling Interval | Sets the time interval for logging data. It is valid for both Run mode and Period mode. <ul style="list-style-type: none"> <li>- Sampling Interval – Hour: sets the hour for log interval</li> <li>- Sampling Interval – Minute: set the minute for log interval</li> <li>- Sampling Interval – Second: sets the second for log interval</li> </ul> | 10 (s)  |
| Period Start      | Sets the start time for Period mode.  |         |
| Period End        | Sets the stop time for Period mode  |         |



Click the *Reset Data Logger* button to clear the data in data storage memory.

### 3.7 Accessible IP

For limiting the devices to access the DL-1000 logger, users can specify particular devices by setting their IP addresses on this page. When the addresses are 0.0.0.0 from IP1 to IP5, all the devices can access the logger. Once any of the 5 IP address columns is set, only the device with which IP is saved in the list can access the logger.

#### ➤ Set accessible IP

1. Select the radio button for *Add \_\_\_\_ . \_\_\_\_ . \_\_\_\_ . \_\_\_\_ To The List* and type the IP address for the accessible device in the following text box.
2. Click on the *Submit* button to the setting effect without restarting.

If the IP setting needs be saved for using after repowered, check the checkbox for *Save to Flash* before clicking the *Submit* button.

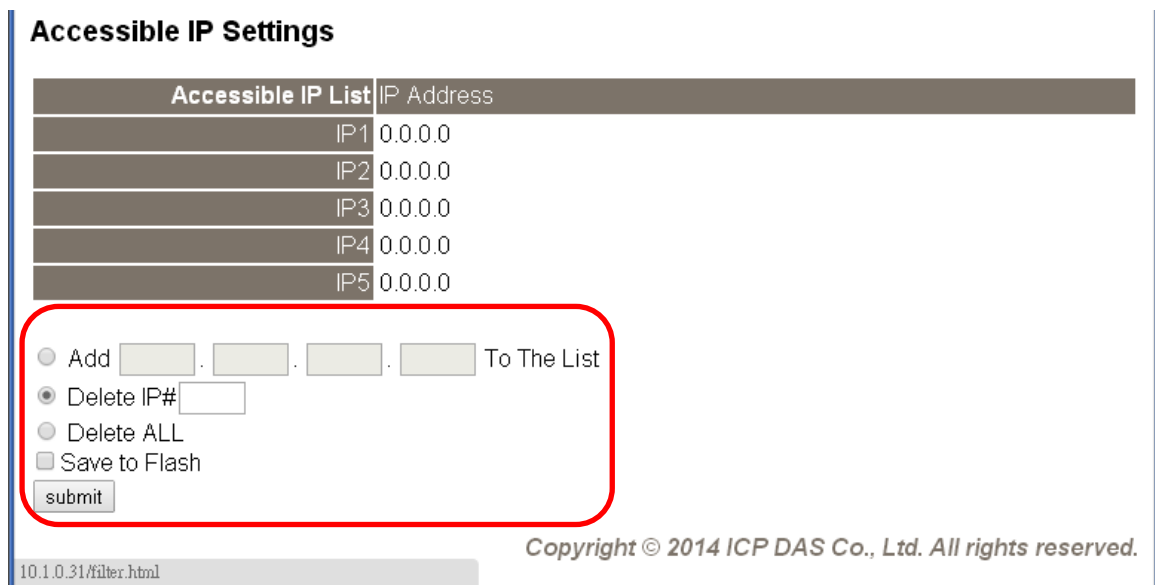

| Accessible IP List | IP Address |
|--------------------|------------|
| IP1                | 0.0.0.0    |
| IP2                | 0.0.0.0    |
| IP3                | 0.0.0.0    |
| IP4                | 0.0.0.0    |
| IP5                | 0.0.0.0    |

Add [ ] . [ ] . [ ] . [ ] To The List  
 Delete IP# [ ]  
 Delete ALL  
 Save to Flash

10.1.0.31/filter.html Copyright © 2014 ICP DAS Co., Ltd. All rights reserved.

#### ➤ Delete IP setting

Select the radio button for *Delete IP#* to delete a specified IP or the radio button for *Delete All* to delete all the IP, check the checkbox for *Save to Flash* and then click the *Submit* button to take the delete operation effect.

### 3.8 Monitor

---

This is only available to the RevB version or firmware version B3.9 and later. It lists the IP of the devices which are connected to the DL-1000 module.

#### Current Connection Status:

|                        |           |
|------------------------|-----------|
| Server Mode            | Server    |
| Connected IP1:         | 10.0.11.3 |
| IP2:                   | 0.0.0.0   |
| IP3:                   | 0.0.0.0   |
| IP4:                   | 0.0.0.0   |
| IP5:                   | 0.0.0.0   |
| IP6:                   | 0.0.0.0   |
| Available Connections: | 31        |

### 3.9 Change Password

---

On this page users can change the passwords for login the logger.

#### ➤ Change Web Password

The password for logging into the web page is **Admin** and can be changed in the *Change Web Password* field. The password can be alphabetic characters or numbers and up to 12 characters (case sensitive).

To change the password, users need enter the *Current password*, *New password*, and *Confirm new password* columns and click the Submit button for Change Web Password to take the setting effect.



#### DL-1023 CO, CO<sub>2</sub>, Particulate Matter, Relative Humidity and Temperature Data Logger

[Home](#) | [Network](#) | [MQTT](#) | [I/O Settings](#) | [Filter](#) | [Monitor](#) | [Change Password](#) | [Logout](#)

#### Change Web Password

The length of the web password is 12 characters maximum.

|                      |                                       |
|----------------------|---------------------------------------|
| Current password     | <input type="text"/>                  |
| New password         | <input type="text"/>                  |
| Confirm new password | <input type="text"/>                  |
|                      | <input type="submit" value="Submit"/> |



## ➤ Change Password

It is recommended to set the Touch Password to protect the logger from unexpected operation. Once the password is set, the password will be requested when entering the setting menu from the touch screen.

The Touch password is numbers from 0 to 9 and up to 8 digits. Enter your password in *New password* and *Confirm new password* and then click the Submit button for changing touch password to take the setting effect. If the password contains non-number characters, the Parameter Error will be displayed as below.



### DL-1023 CO, CO<sub>2</sub>, Particulate Matter, Relative Humidity and Temperature Data Logger

[Home](#) | [Network](#) | [MQTT](#) | [I/O Settings](#) | [Filter](#) | [Monitor](#) | [Change Password](#) | [Logout](#)

#### Parameter Error

One of the parameters entered on the previous page was either invalid or missing. Please use the back button on your browser to return to the configuration page and check the values entered, then reapply your setting changes.

## 3.10 Logout

---

Click the Logout on any page to logout the DL-1000.



### DL-1023 CO, CO<sub>2</sub>, Particulate Matter, Relative Humidity and Temperature Data Logger

[Home](#) | [Network](#) | [MQTT](#) | [I/O Settings](#) | [Filter](#) | [Monitor](#) | [Change Password](#) | [Logout](#)

#### The system is logged out.

To enter the web configuration, please type password in the following field.

Login password:



When using IE, please disable its cache as follows.

Menu items: [Tools](#) / [Internet Options...](#) / [General](#) / [Temporary Internet Files](#) / [Settings...](#) / [Every visit to the page](#)

---

## 4. Configuration via RS-485

- The factory default settings for RS-485 communication
  - Address: 1
  - Protocol: Modbus/RTU
  - Baudrate: 9600
  - Parity: N,8,1
  - Response Delay (ms): 0

### Note

---

If there are multiple DL-1000 loggers connected to the same RS-485 network, each logger needs to be set with a unique RS-485 address. More than one module having the same address will cause communication failure

---

- Testing RS-485 Communication
  1. Download the DCON Utility Pro from  
CD:\Napedos\IIoT\utility\DCON\_utility\_pro  
[http://ftp.icpdas.com/pub/cd/usbcd/napdos/iiot/utility/dcon\\_utility\\_pro/](http://ftp.icpdas.com/pub/cd/usbcd/napdos/iiot/utility/dcon_utility_pro/)
  2. Launch the DCON\_UTILITY\_Pro.exe.

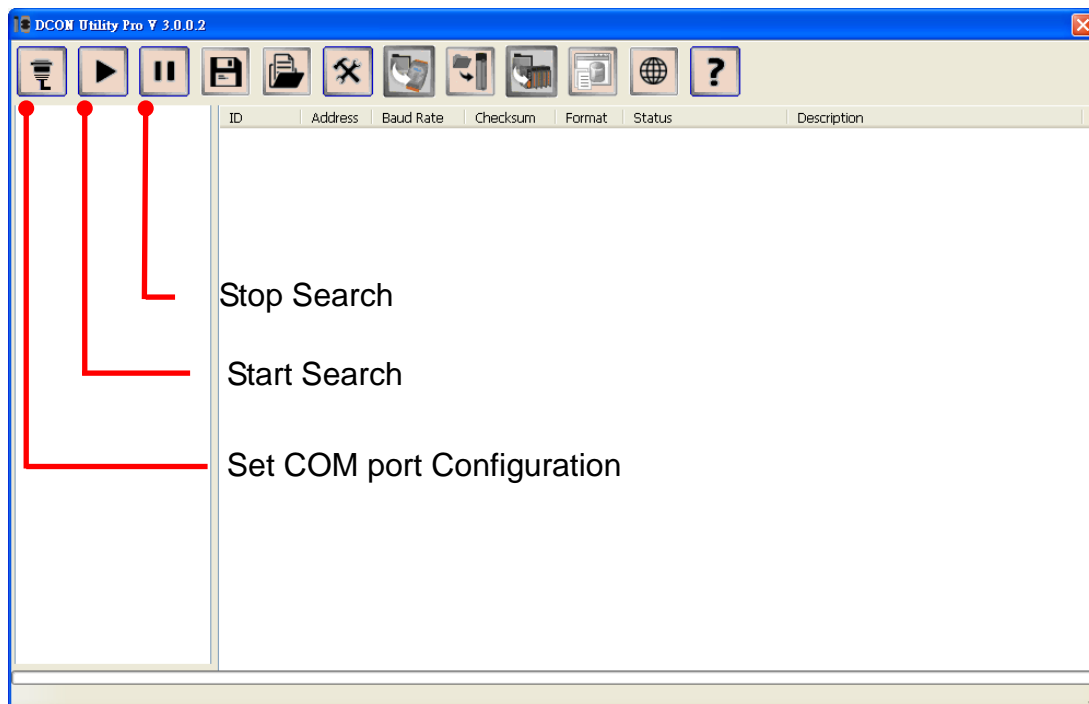

3. Click the icon  to configure the COM port.

4. Select the COM Port number used to connect the DL-1000 logger.

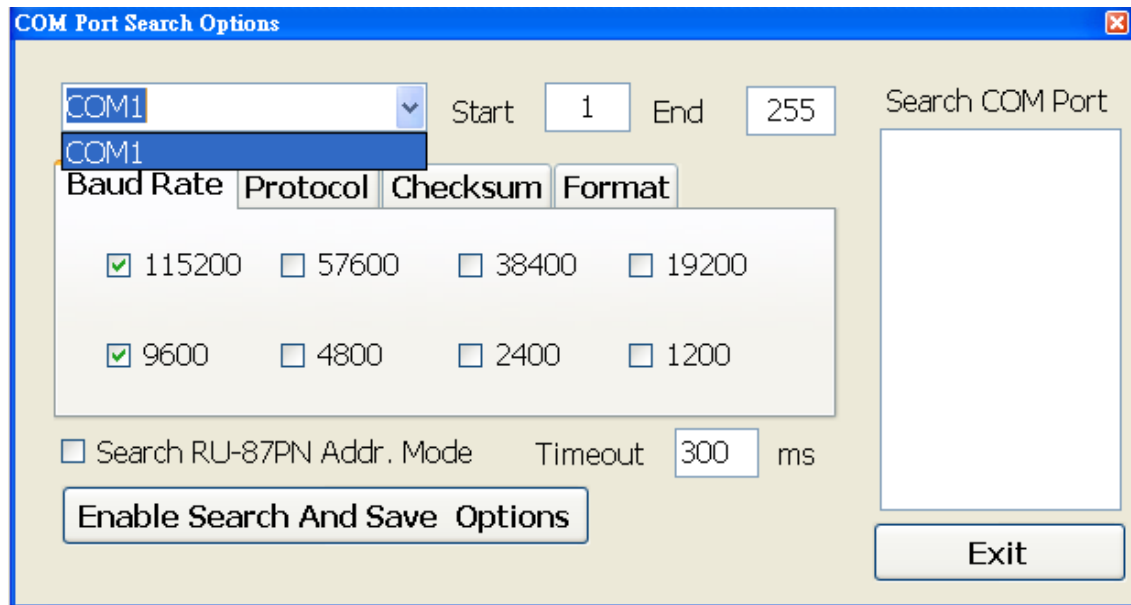

5. The Baud Rate is factory default to 9600 bps, make sure the baud rate setting in the logger is checked in the Comport Option dialog box.

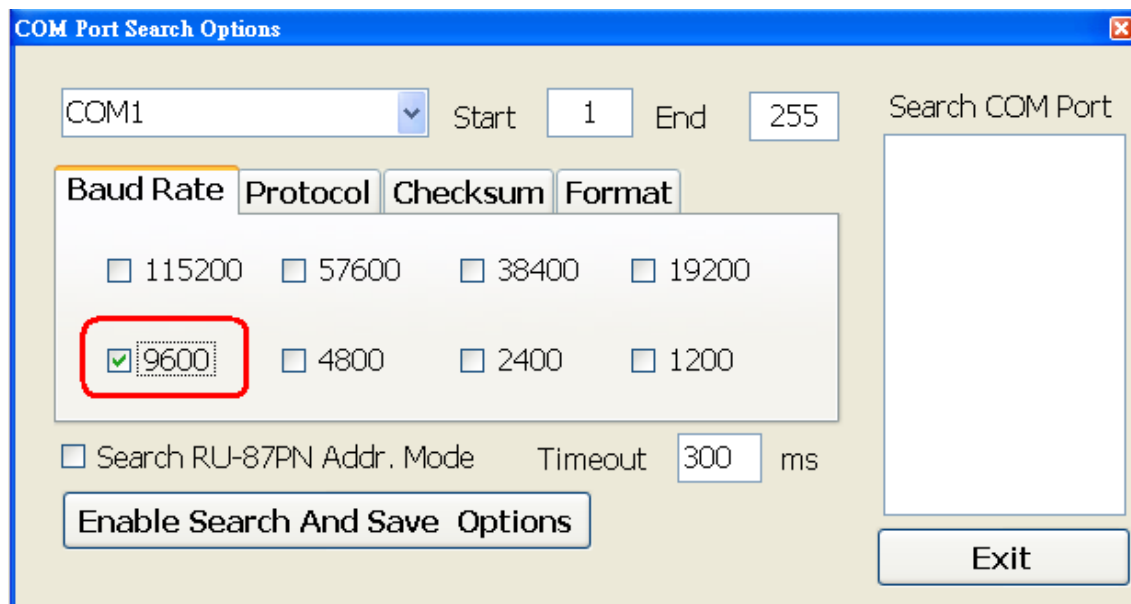

6. Select the Protocol tab and check the protocol that set in the logger.

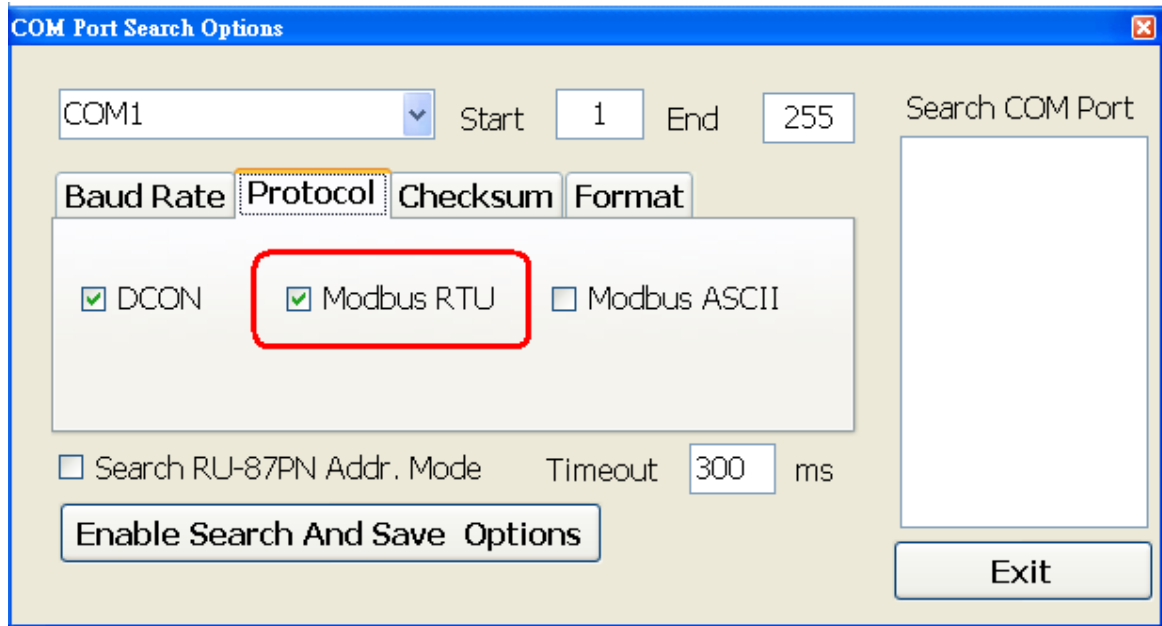

7. Select the Format tab and check the parity that set in the logger.

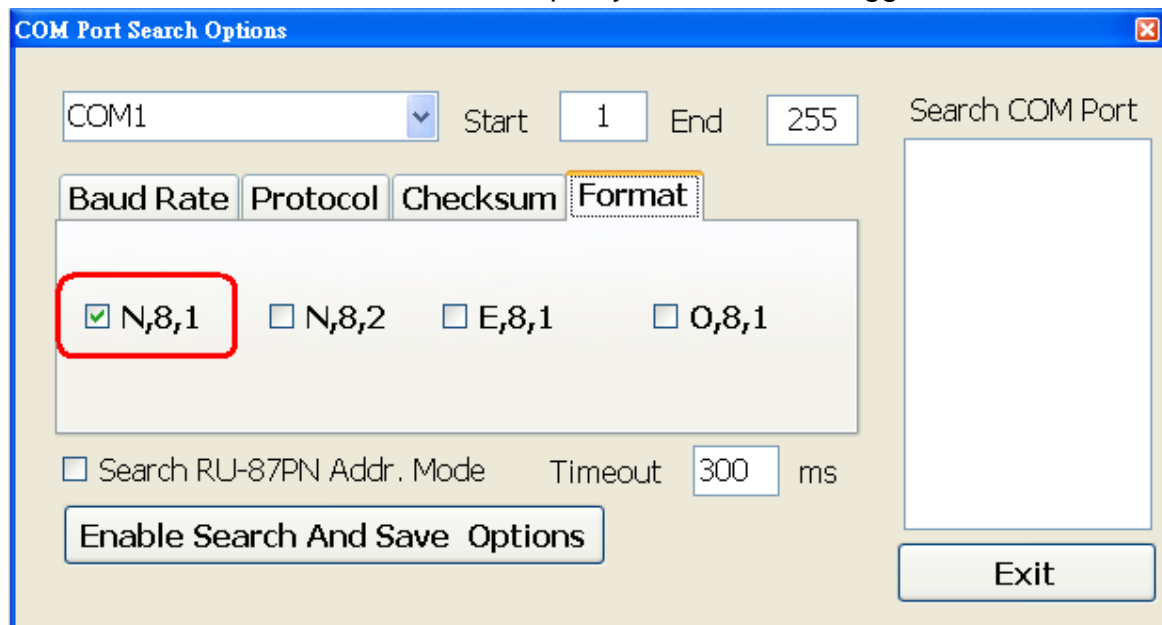

8. Click the Start Search icon.



9. The DL-1000 logger searched out will be listed as below.

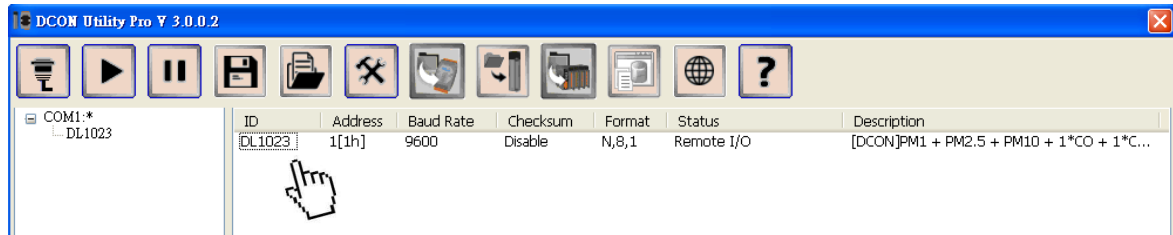

10. Click the module name to configure the logger.

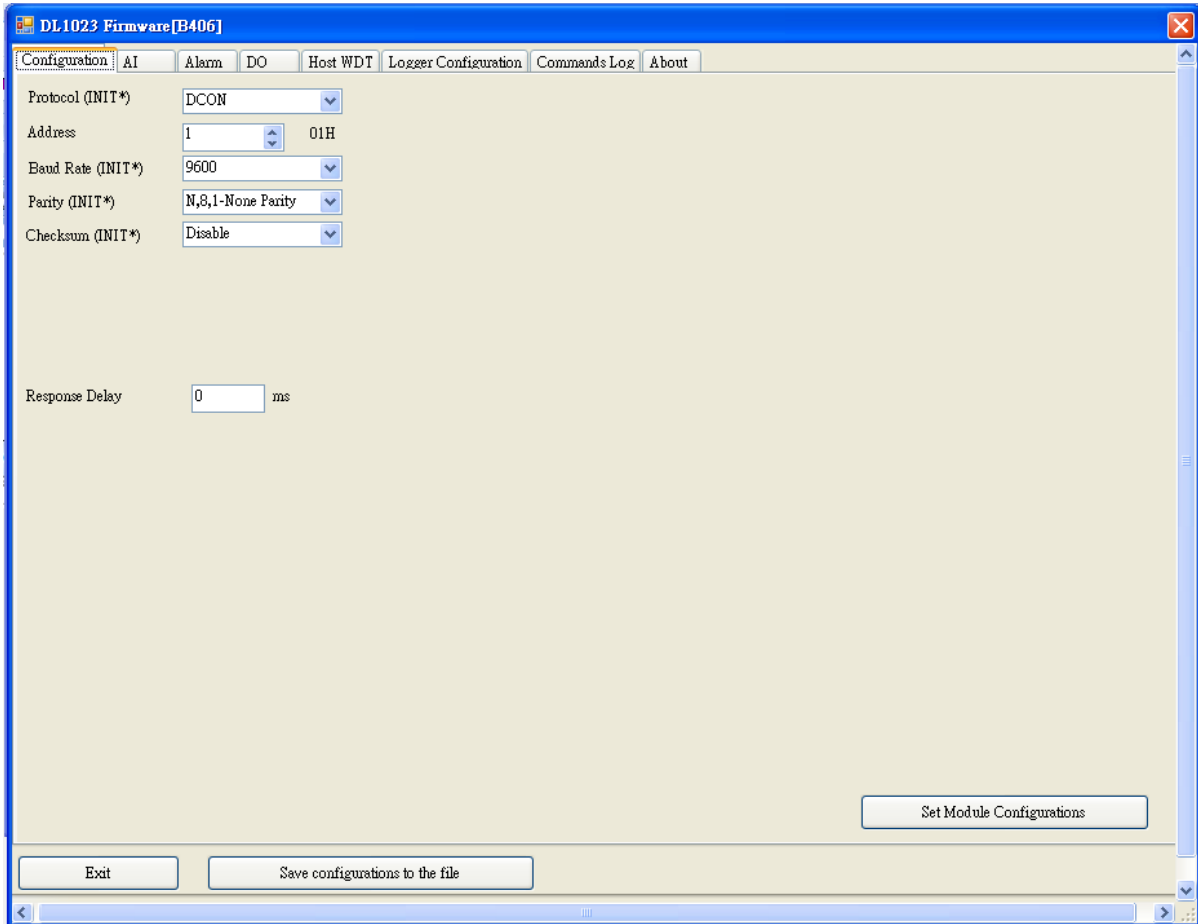

## Note

The Protocol/Baud Rate/Parity/Checksum items marked with "(INIT\*)" means that when any of those items needs be modified, the pin 4.INIT needs to be set in ON position and power cycle the logger, then the item can be modified. After complete setting, set the pin 4.INIT back to OFF position and power cycle the logger again to take the setting effect.

➤ **AI tab**

CO/CO<sub>2</sub>/PM2.5/PM1.0/PM10 level

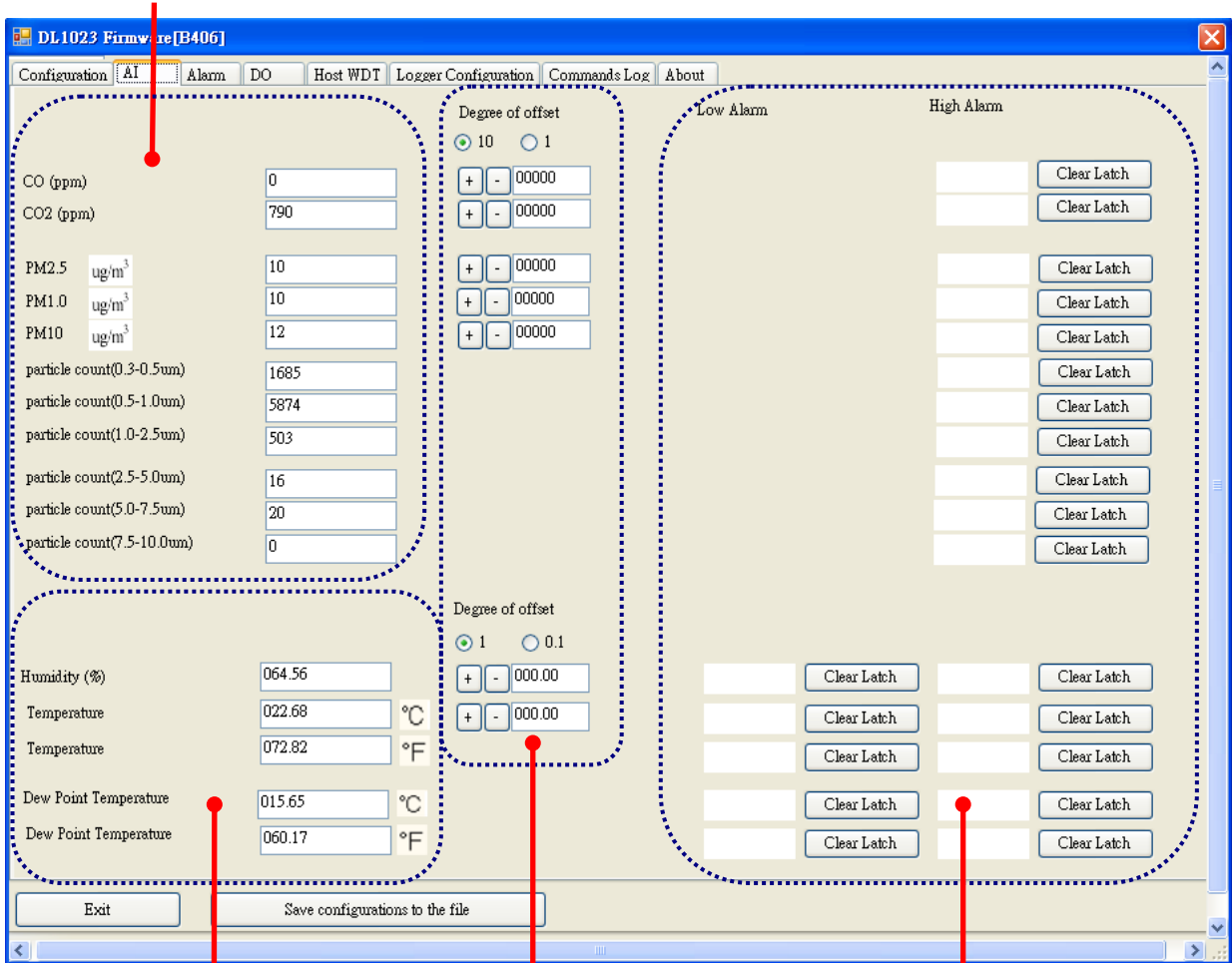

Humidity  
Temperature and  
Dew point temperature

Adjust the  
CO/CO<sub>2</sub>/PM2.5/PM1.0  
/PM10/humidity/tempe  
rature offset

Alarm Status

➤ Alarm tab

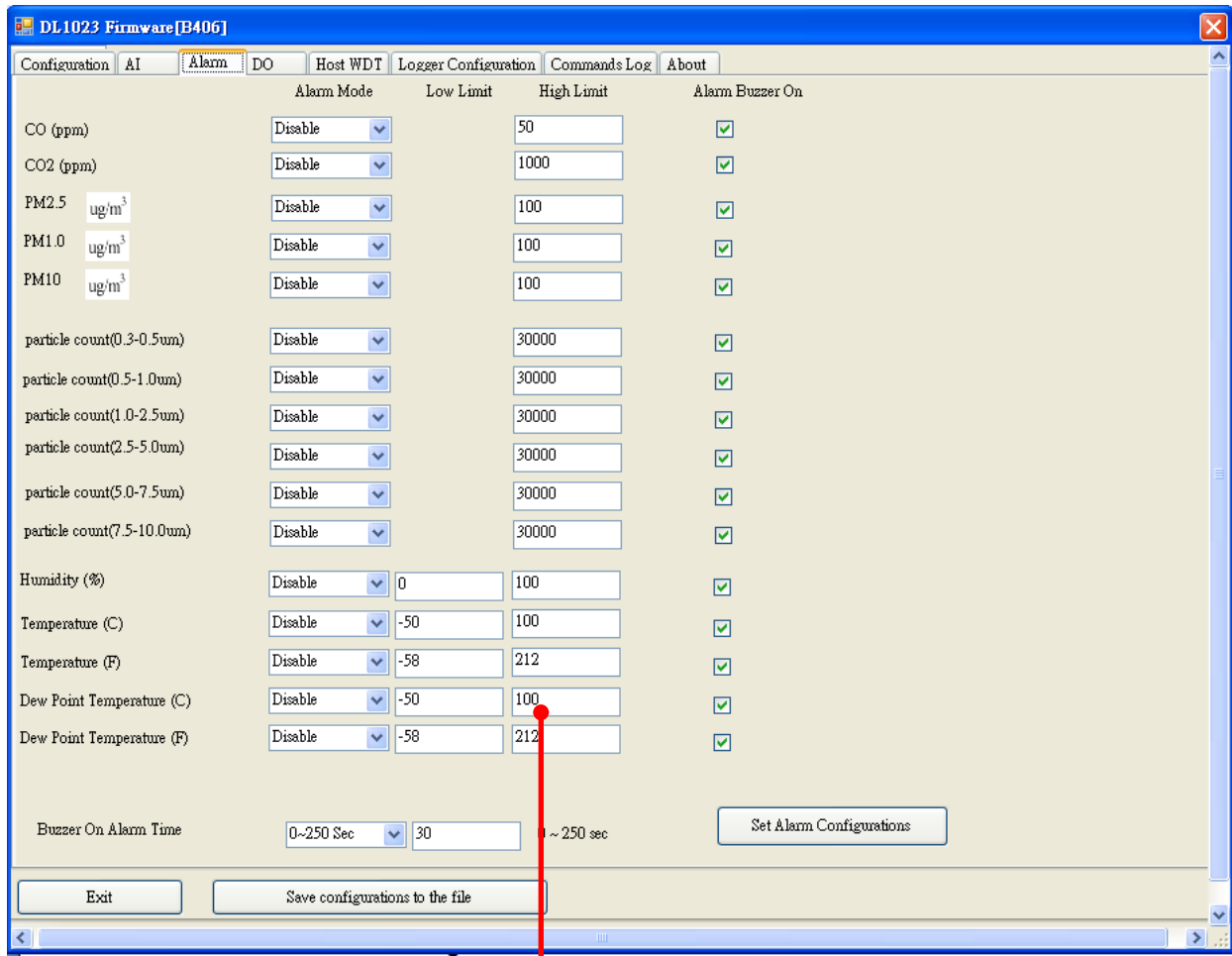

Set alarm mode/Low alarm limit/High alarm limit

➤ **DO tab**

On this DO0~DO3 tab, users can control the relay to output ON or OFF status, and set the power on value and safe value for the relay output.

When any one of the high/low limit alarm for CO/CO<sub>2</sub>/ concentration, PM2.5, PM1.0/PM10, temperature, humidity and dew point is enabled, the functions on this tab are all disabled as below.

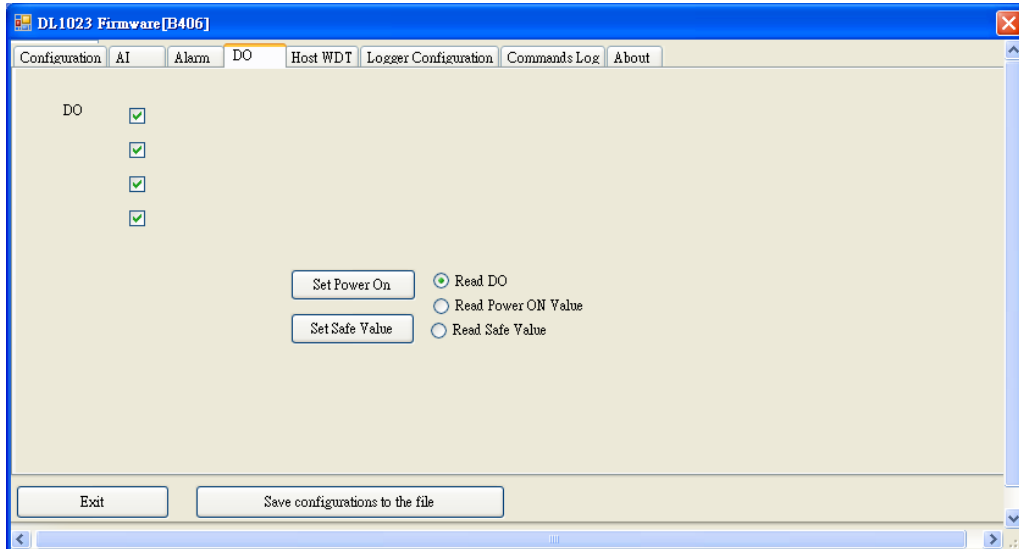

If all the alarm events are disabled, the functions are available as below:

The checkbox can be used to control and display the DO status. Check/Uncheck the checkbox can control the relay output. Checked/Unchecked symbol also means the DO status

When the buttons are clicked, the DO status will be set as the Power On value or Safe value.

Select one of the radio button and the checkbox next to DO will display the setting for selected item.



## ➤ Host Watchdog

Host Watchdog is used to monitor the RS-485 communication status; if the host (PC) does not send command “~\*\*” in the time period of WDT Timeout setting, the enabled Host Watchdog will announce the timeout error and turn the relay output to Safe value to avoid an unsafe act. Users can not control the relay until the command “~AA1” is sent to clear the WDT timeout status.

On this tab:

1. Set the time period for WDT timeout, check the checkbox next to Enable WDT and click the Set WDT button to enable the Host watchdog.
2. Check the checkbox next to Send Host OK to send the “~\*\*” command.
3. Uncheck the checkbox next to Send Host OK to stop sending ~\*\* command, the Host watchdog timeout will occur and relay will turn to Safe value.
4. Click the Reset WDT button to clear the Host watchdog timeout status.
5. Uncheck the checkbox next to Enable WDT and click the Set WDT button to disable the Host watchdog.

### Note

The relay will not turn to Safe value when any one of the alarm for CO/CO<sub>2</sub> concentration, PM2.5, PM1.0, PM10, temperature, humidity and dew point is enabled. If any one alarm is enabled, the relay will be linked to the Alarm status. In case an Alarm occurs, the relay turns ON, it can be used to turn on the user’s alarm light or beeping alarm or other device.

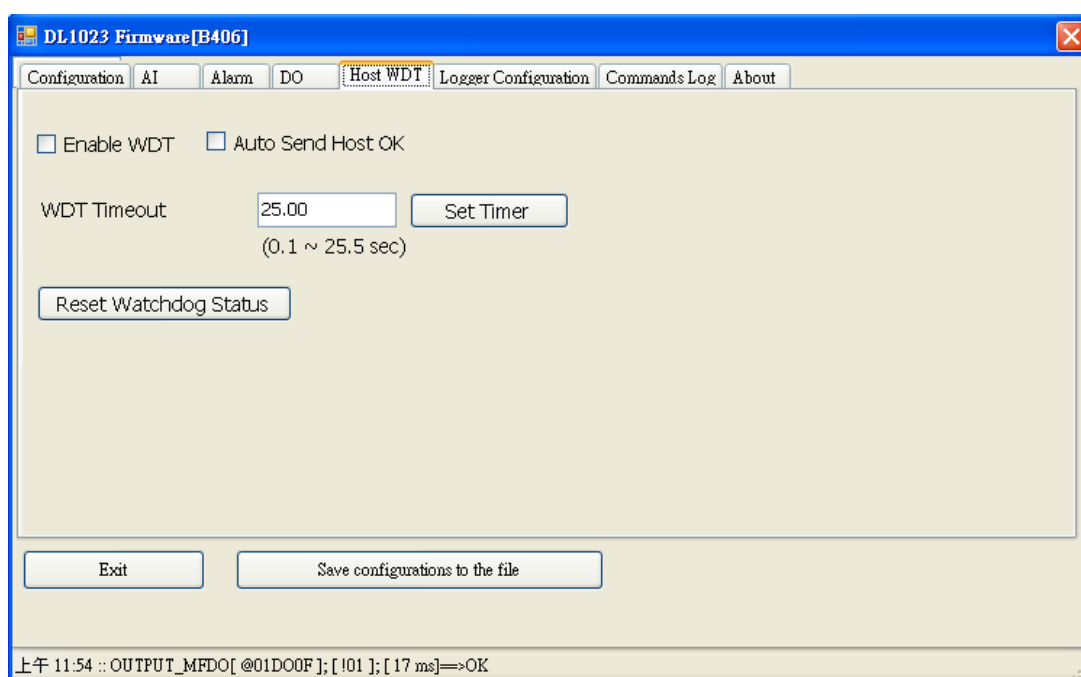

➤ **Data Logger Tab**

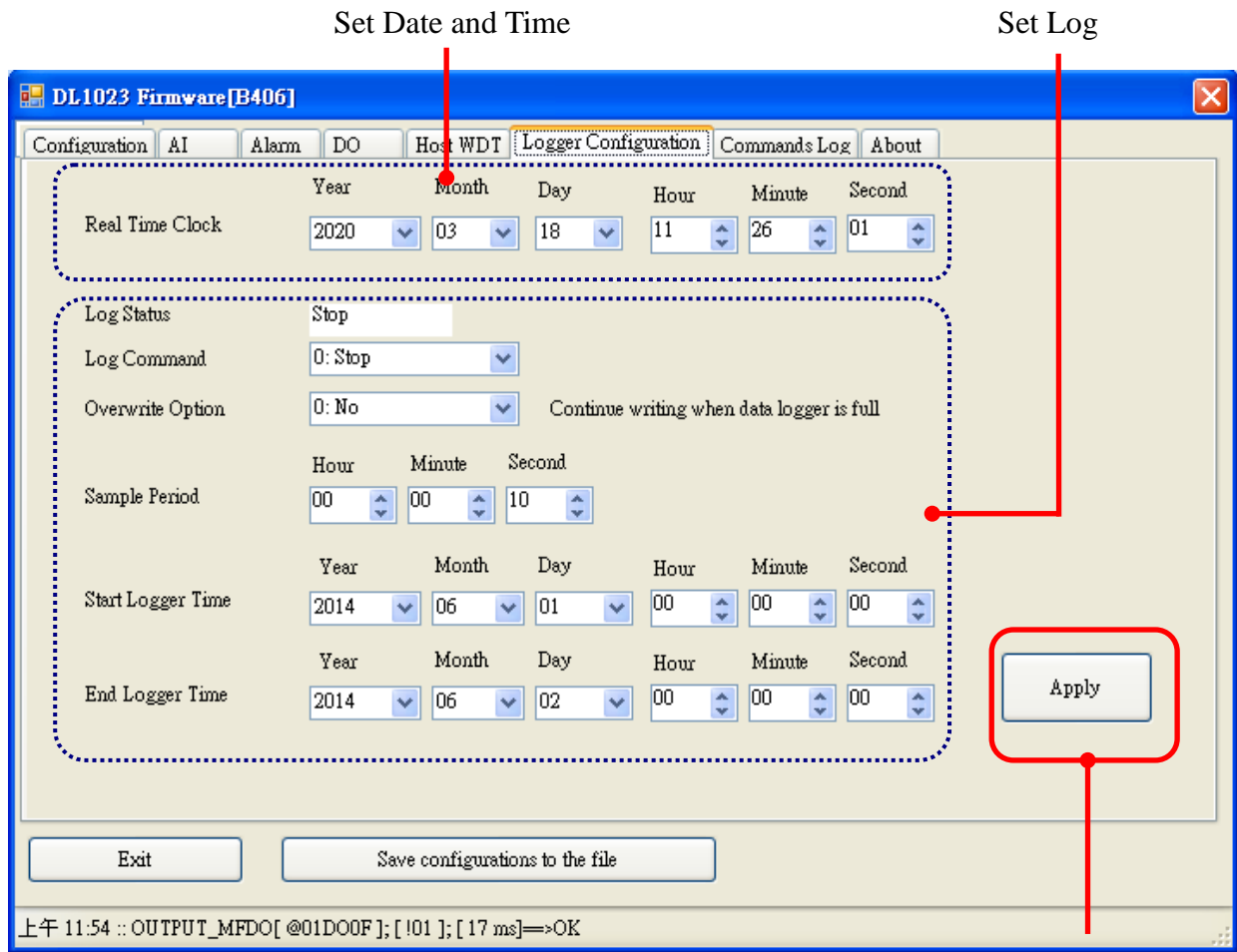

Click the Apply button to save settings.

➤ INIT

In case of the following situations, users have to set the pin 4.INIT on SW1 in the ON position and power-cycle the DL-1000 module:



- Change protocol from PC
- Change DCON configuration such as baud rate, parity and checksum
- Communication failure with a DL-1000 module.

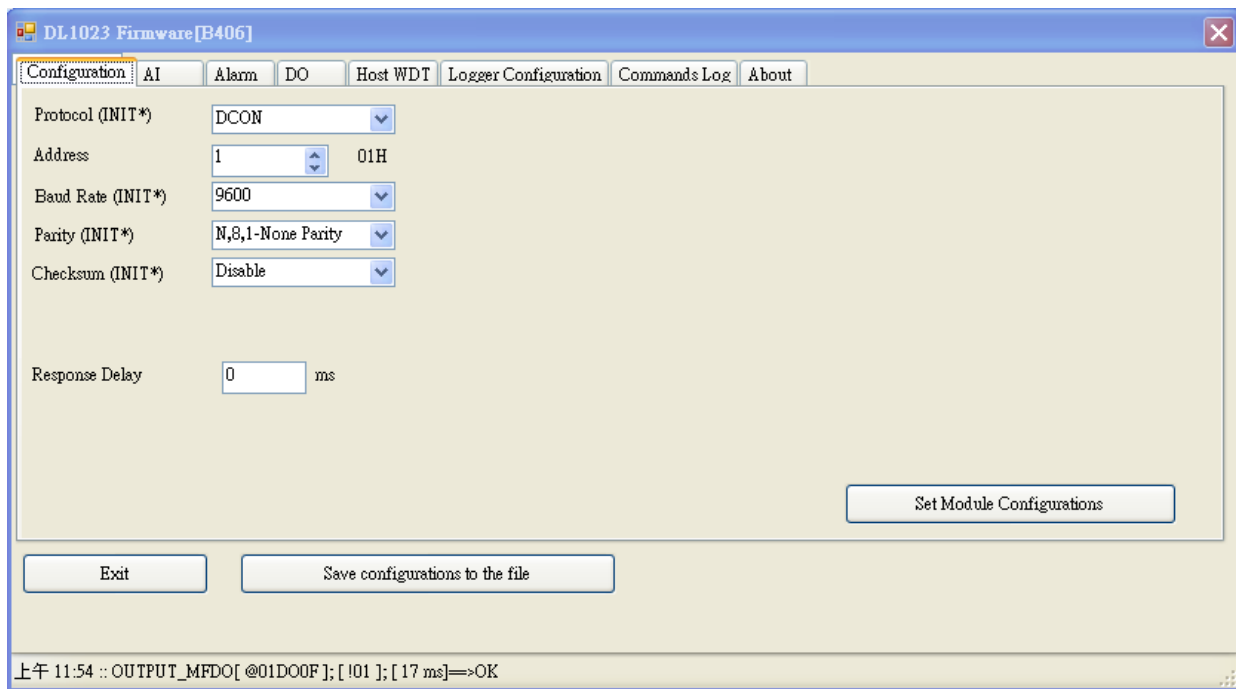

When a DL-1000 module is powered-on with the pin 4.INIT in ON position, the protocol is DCON, address is 0, Baud Rate is 9600 bps, Parity is set to N/8/1 and Checksum is disabled.

After configuring the communication parameters, click the *Set Module Configurations* button, set the INIT to OFF position and power-cycle the DL-1000 to take the settings effect.

**Note**

---

The INIT switch does not need to be set in the ON position when changing the address, baudrate and parity for ModbusRTU communication; users only have to power-cycle the module after complete configuration.

---

---

## 5. Monitoring via Mobile Devices

The iAir App can be used to monitor real-time data of CO/CO<sub>2</sub> level, temperature and humidity anywhere and anytime without any complicated configuration. The DL-1000 modules and your mobile devices such as smart phones or tablets need be addressed on the same network, and then you can get the real-time data from DL-1000 loggers by entering a specific IP address, or by performing an automatic search for available devices.

If a DL-1000 cannot be searched in the iAir App, please contact with the network administrator to make sure the module and your mobile devices are addressed on the same sub-network. It means that they have the same broadcast address.



The iAir app is available to free download in Google Play and App Store. Search “iAir” in or search “iAir”, “ICPDAS” in App Store and tap on install.

The iAir user manual can be obtained from

<http://ftp.icpdas.com/pub/cd/usbcd/napdos/iiot/dl-1000/document/>

---

## 6. Utility to Get/Manage Data Log

DL300 Utility is a convenient, easy-to-use management utility running on Windows platform that allows users to monitor the real-time data and trend chart from DL-1000 modules on the Ethernet, it can group the DL-1000 modules for group view management, log alarm events with timestamp, download the logged data from a DL-1000 logger and export the data to \*.csv files for performing statistical analysis in Excel.

The DL-300 Utility can be obtained from:

CD: \Napdos\IIoT\utility\DL300\_utility

[http://ftp.icpdas.com/pub/cd/usbcd/napdos/iiot/utility/dl300\\_utility/](http://ftp.icpdas.com/pub/cd/usbcd/napdos/iiot/utility/dl300_utility/)

1. Run the DL300\_utility\_setup\_YYYYMMDD.exe, the default install location is C:\ICPDAS\DL300\_UTILITY\DL-300 Utility

2. Open the DL-300 Utility by double clicking on the DL-300 Utility shortcut on desktop.



3. Search out a DL-1000 module on the Ethernet and set the configuration.

3-1. Select the **Device Settings** on the **Settings** menu.

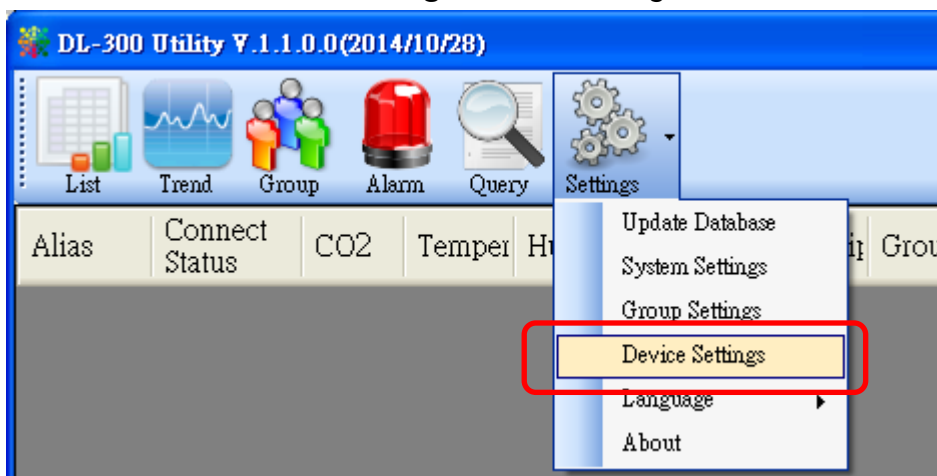

- 3-2. Click the **Search New Device** button to search the DL-1000 modules connected on the same Ethernet network.
- 3-3. Check the checkbox next to a module and click the **Add** button to add the module in the utility.
- 3-4. Highlight a module and click the **Edit Device** button to configure the module.

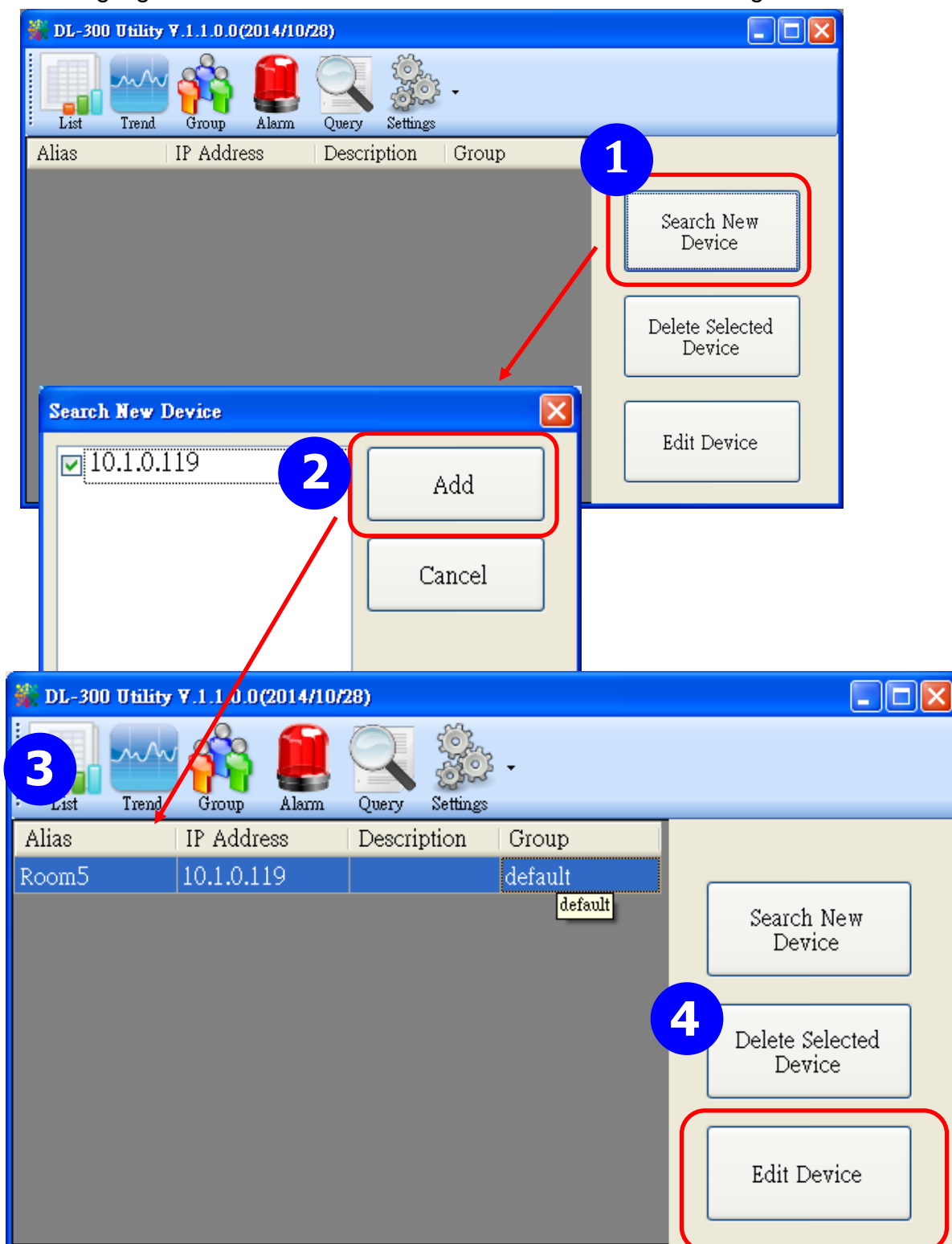

3-5. Set the configuration, and click on the **OK** button.

**Note**

Consult your network administrator before making changes to IP Address/ Mask Address/ Gateway

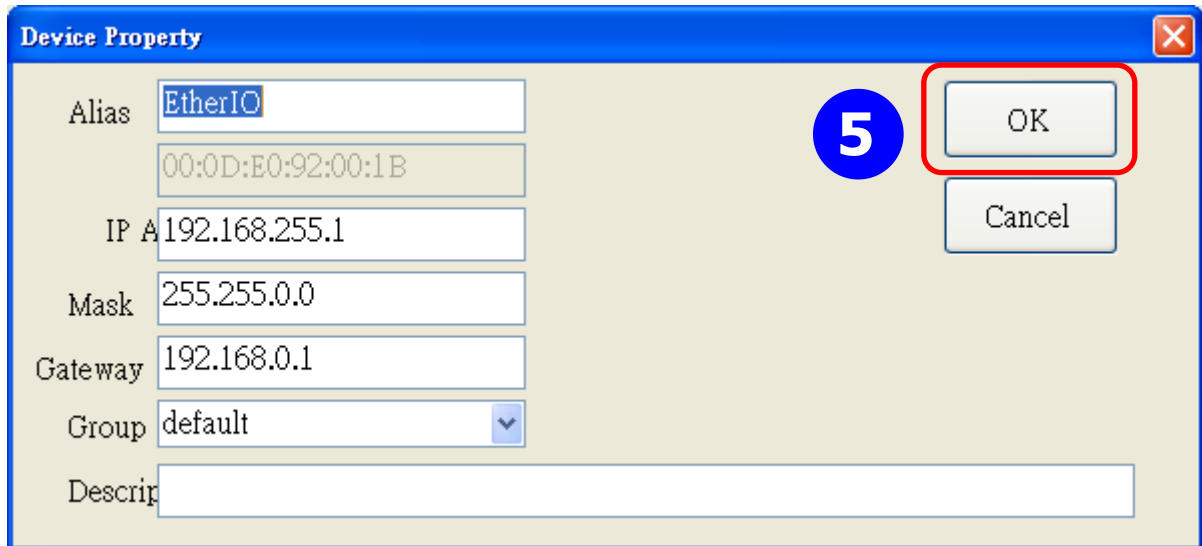

4. Get real-time data, trend chart and alarm event.

4-1. Click the **List** icon to obtain the real-time data. It also lists the connect status, group information and IP address for every DL-1000 logger.

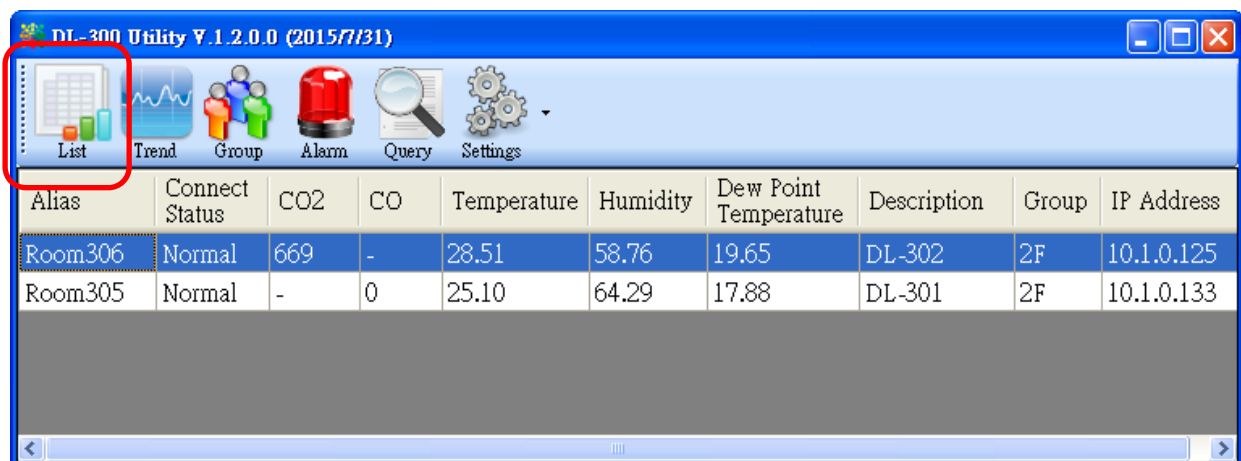

4-2. Click the **Trend** icon to display the trend chart. Users can select the radio button for CO/CO<sub>2</sub> level, Temperature or Humidity to access the trend chart for those real-time data, check the checkbox next to each DL-1000 logger to display its trend chart or uncheck it to cancel display. Drag and drop the trend chart can move it to see the data not be displayed in the chart.

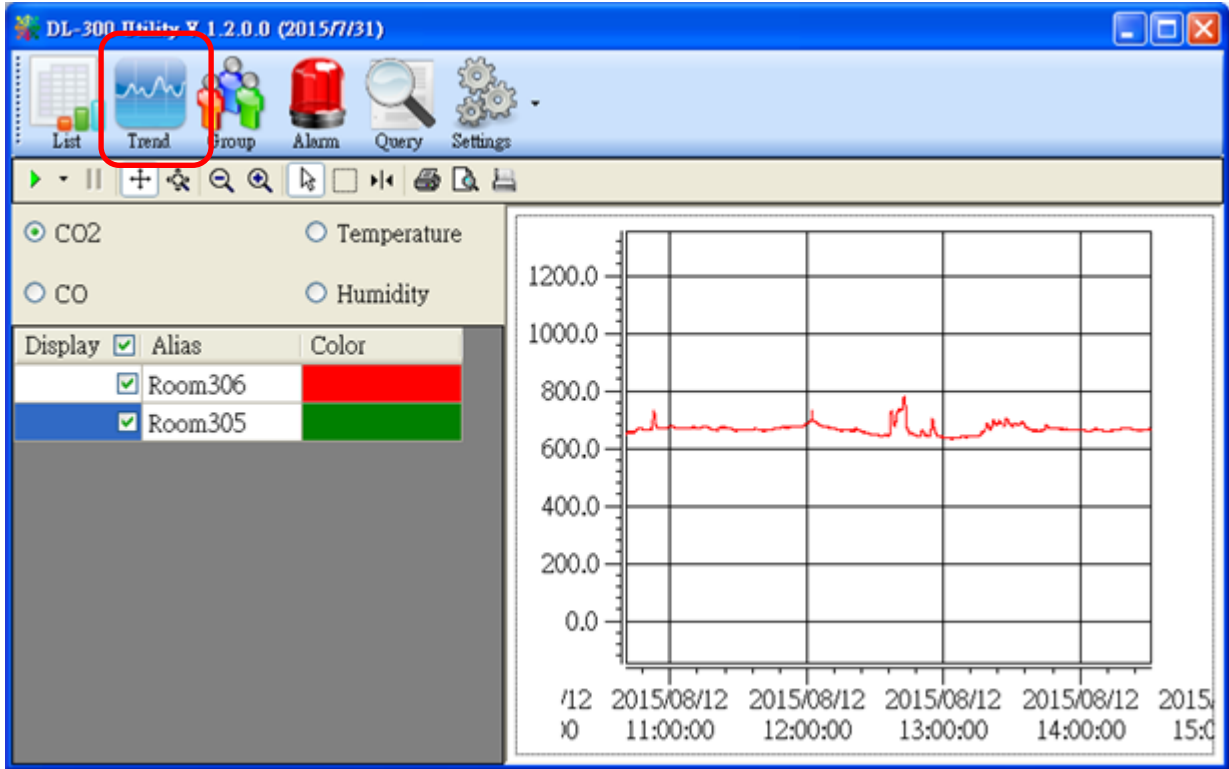

4-3. Click the **Alarm** icon to review the alarm events.

| Alias  | CO2 | Temperature | Humidity | Dew Point | Description | Group | IP Address | Alarm                                      |
|--------|-----|-------------|----------|-----------|-------------|-------|------------|--|
| Room8A | 901 | 25.4        | 62.86    | 17.8      |             | 1F    | 10.1.0.120 | CO2 is over Alert Value at time:2014/11/21 |
| Room8A | 904 | 25.42       | 62.89    | 17.83     |             | 1F    | 10.1.0.120 | CO2 is over Alert Value at time:2014/11/21 |
| Room8A | 899 | 25.33       | 62.86    | 17.74     |             | 1F    | 10.1.0.120 | CO2 is over Alert Value at time:2014/11/21 |
| Room8A | 898 | 25.34       | 62.83    | 17.74     |             | 1F    | 10.1.0.120 | CO2 is over Alert Value at time:2014/11/21 |
| Room1A | 796 | 27.4        | 56.97    | 18.11     |             | 1F    | 10.1.0.86  | CO2 is over Alert Value at time:2014/11/21 |
| Room1A | 795 | 27.46       | 56.98    | 18.17     |             | 1F    | 10.1.0.86  | CO2 is over Alert Value at time:2014/11/21 |
| Room1A | 792 | 27.44       | 56.98    | 18.15     |             | 1F    | 10.1.0.86  | CO2 is over Alert Value at time:2014/11/21 |
| Room1A | 794 | 27.42       | 56.99    | 18.14     |             | 1F    | 10.1.0.86  | CO2 is over Alert Value at time:2014/11/21 |
| Room1A | 791 | 27.45       | 56.95    | 18.15     |             | 1F    | 10.1.0.86  | CO2 is over Alert Value at time:2014/11/21 |
| Room1A | 793 | 27.45       | 56.98    | 18.16     |             | 1F    | 10.1.0.86  | CO2 is over Alert Value at time:2014/11/21 |



#### 4-4. Modify the event condition.

Select the **System Settings** on the **Settings** menu.

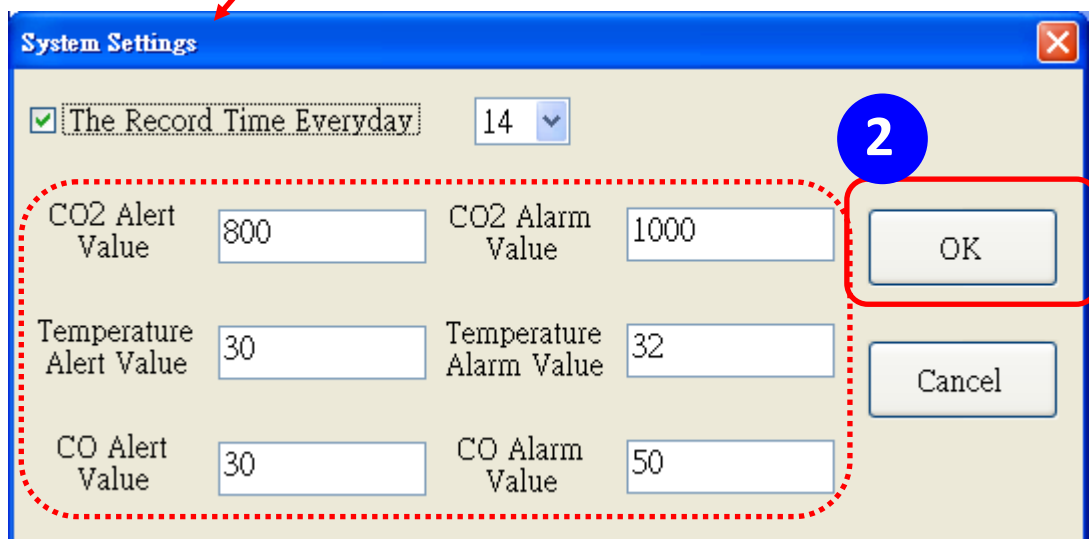
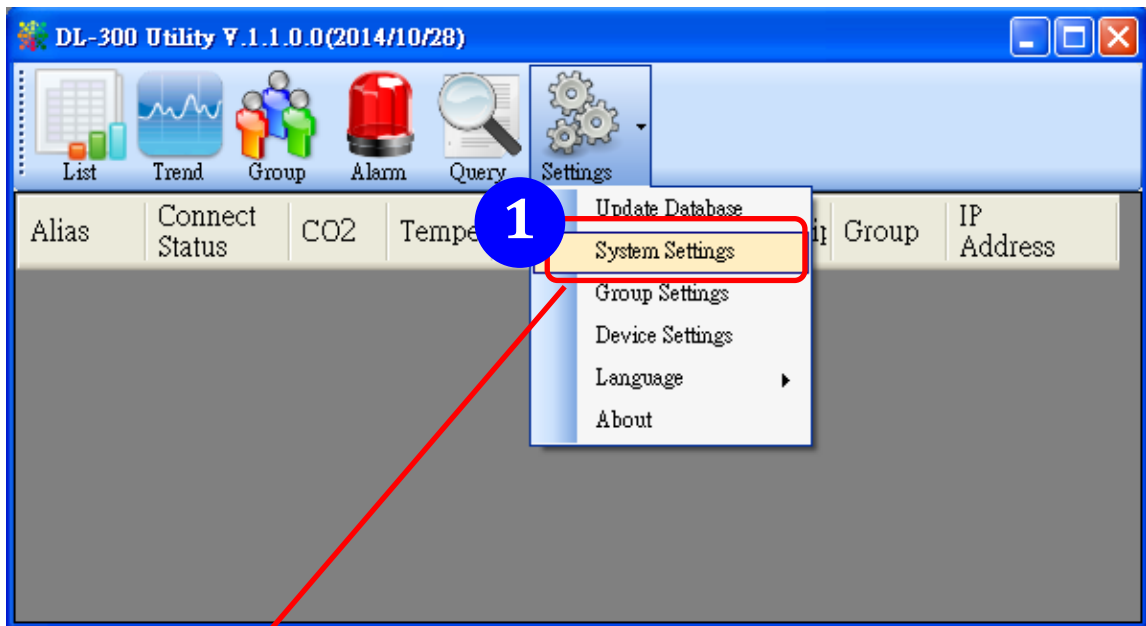

Set the *CO/CO2 Alert Value*, *CO/CO2 Alarm Value* (If it is supported in the logger), *Temperature Alert Value* and *Temperature Alarm Value* for trigger events. Check the checkbox next to *The Record Time Everyday* can schedule auto generate report everyday at the time set in the dropdown menu. Click on the **OK** button to complete the settings.

- 5. Download data in a DL-1000 logger and export the data
  - 5.1. Select **Update Database** on the Settings menu
  - 5.2. Click the **Start** button to download the data in DL-1000 modules.
  - 5.3. Click the close icon to exit the download procedure when all data are downloaded.

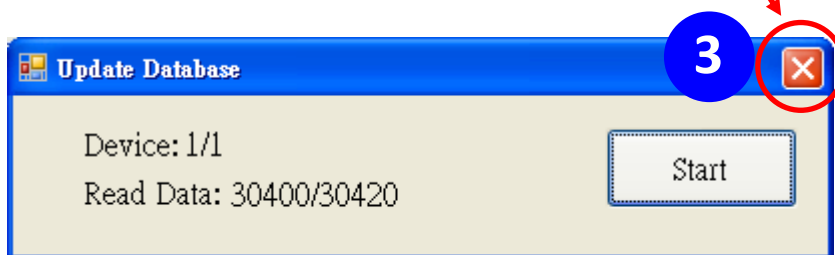
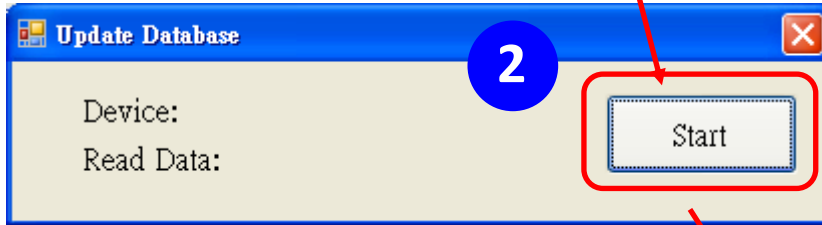
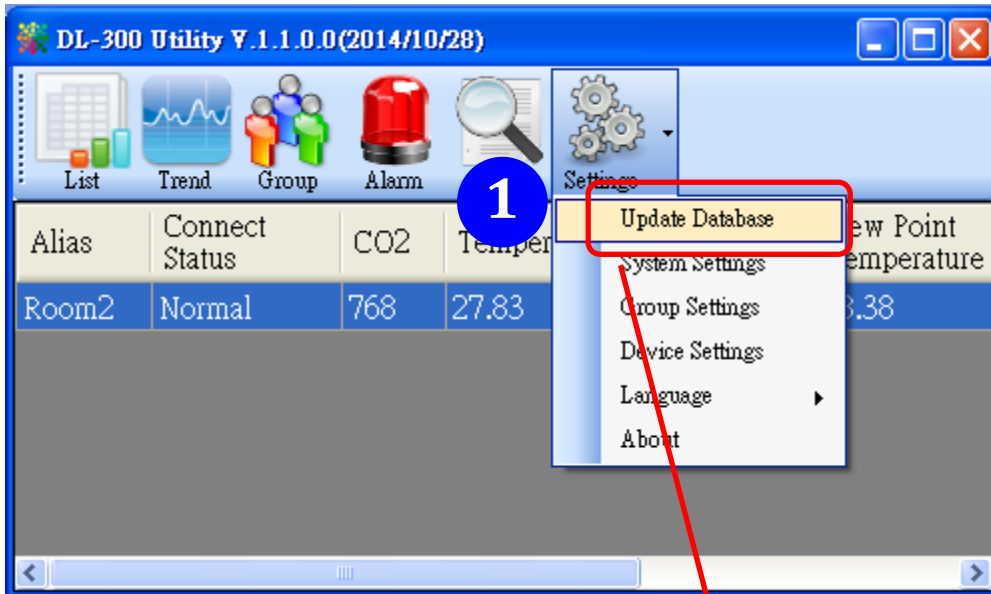

5.4. Click the **Query** icon.

5.5. Highlight the desired module, set the *Start Time* and *End Time*, and then click the **Search** button. The data in the time period will be listed as below.

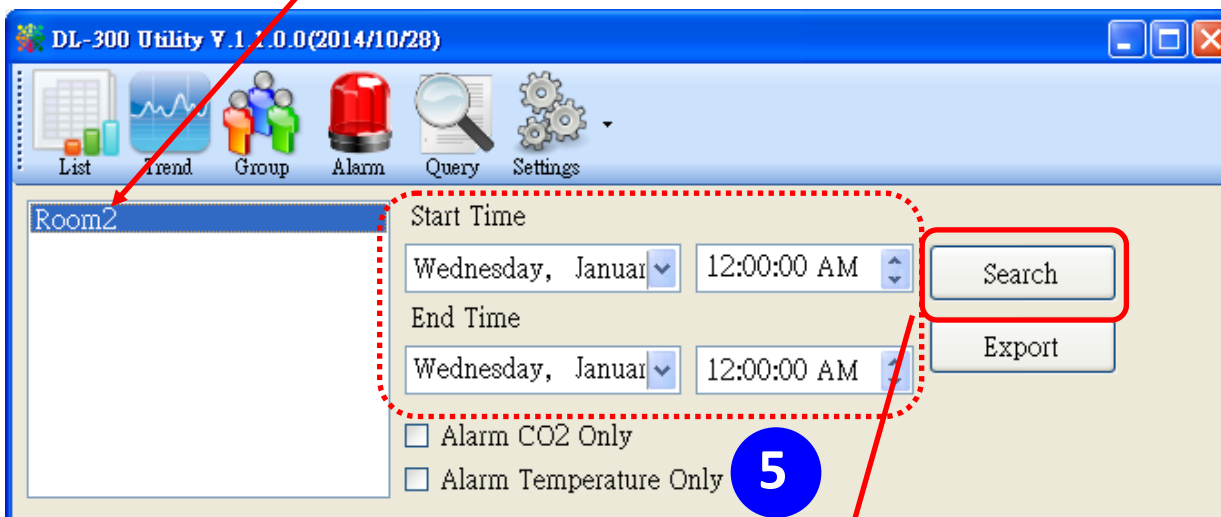
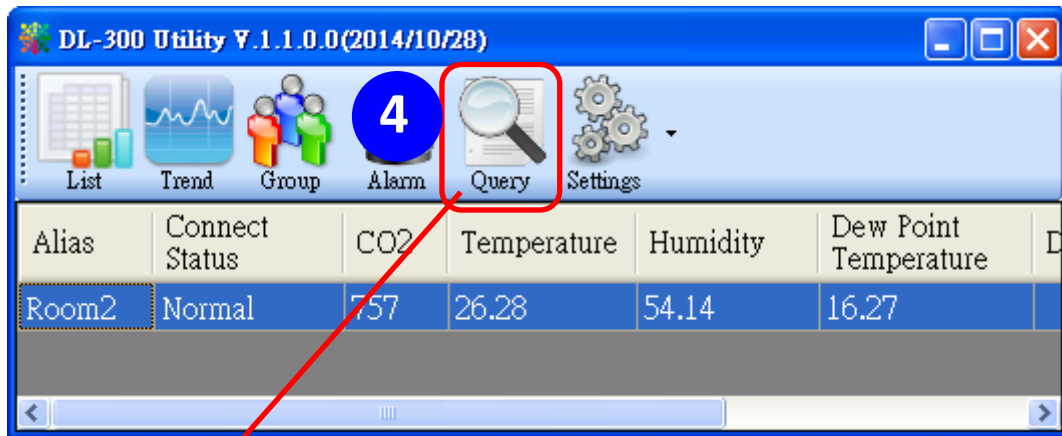

| Time           | CO2  | Humidity | Temperature | Dew Point |
|----------------|------|----------|-------------|-----------|
| 2014/11/25 ... | 0    | 67.85    | 23.19       | 16.76     |
| 2014/11/25 ... | 853  | 66.72    | 23.42       | 16.76     |
| 2014/11/25 ... | 1187 | 67.29    | 23.7        | 17.16     |
| 2014/11/25 ... | 864  | 65.07    | 23.92       | 16.93     |
| 2014/11/25 ... | 923  | 64.83    | 24.13       | 17.1      |
| 2014/11/25 ... | 852  | 64.34    | 24.32       | 17.19     |
| 2014/11/25 ... | 818  | 63.25    | 24.52       | 17.17     |
| 2014/11/25 ... | 796  | 62.58    | 24.68       | 17.2      |

5.6. Click the **Export** button to export the searched data in \*.csv files for performing statistical analysis in Excel.

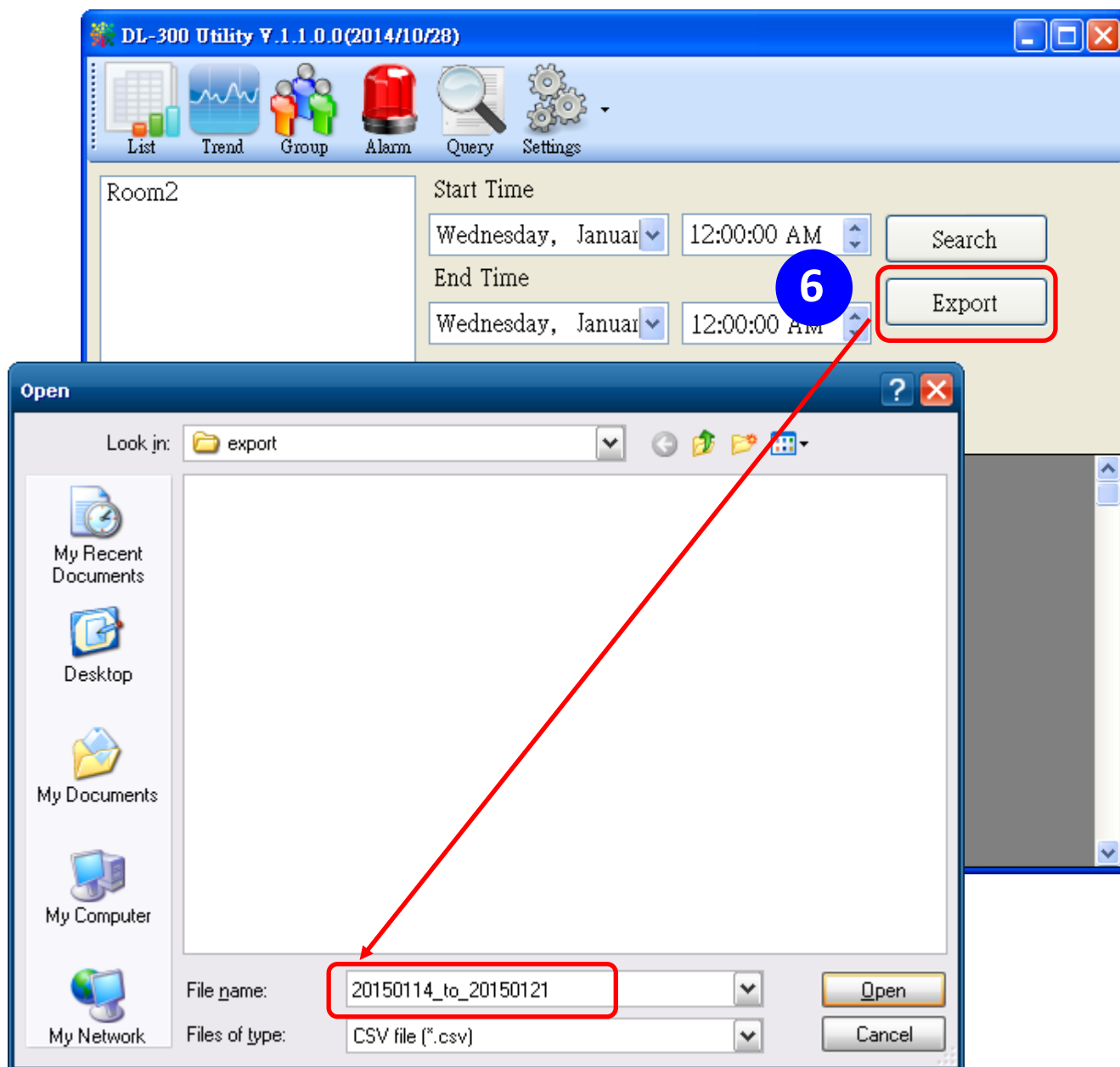

- 6. Group the devices by location or users
  - 6.1. Select **Group Settings** on the Settings menu.

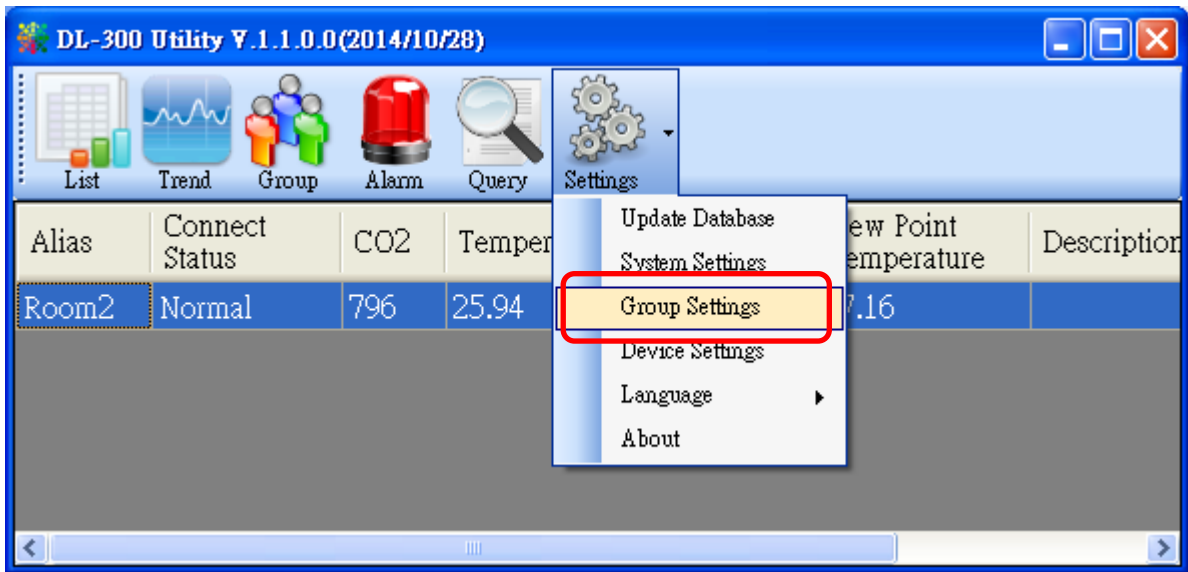

- 6.2 Click the **New** button, enter the group name and click the **OK** button in the pop-up box, and then click the **OK** button in the Group Settings box.

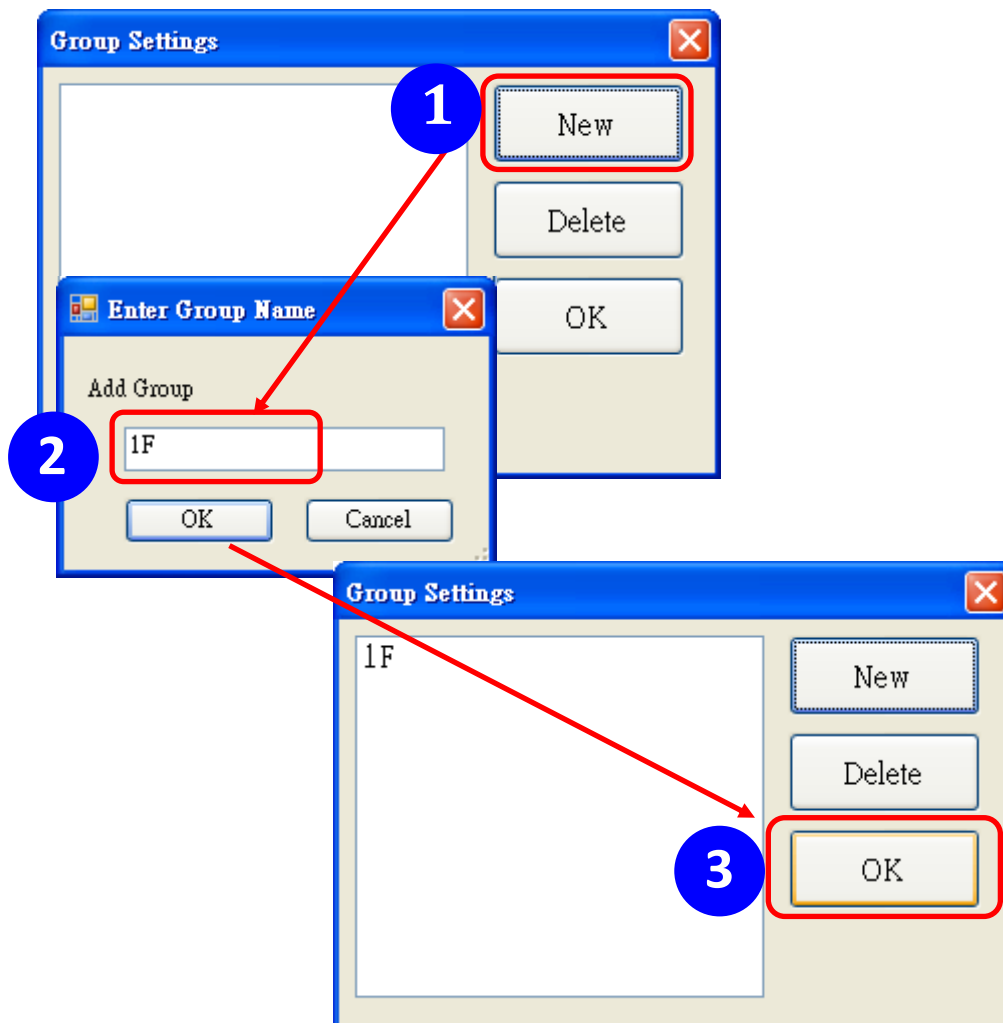

6-3. Select **Device Settings** on the **Settings** menu; highlight the desired device and click the **Edit Device** button, select the group name for the module and click the **OK** button in the pop-up **Device Property** box to complete the setting.

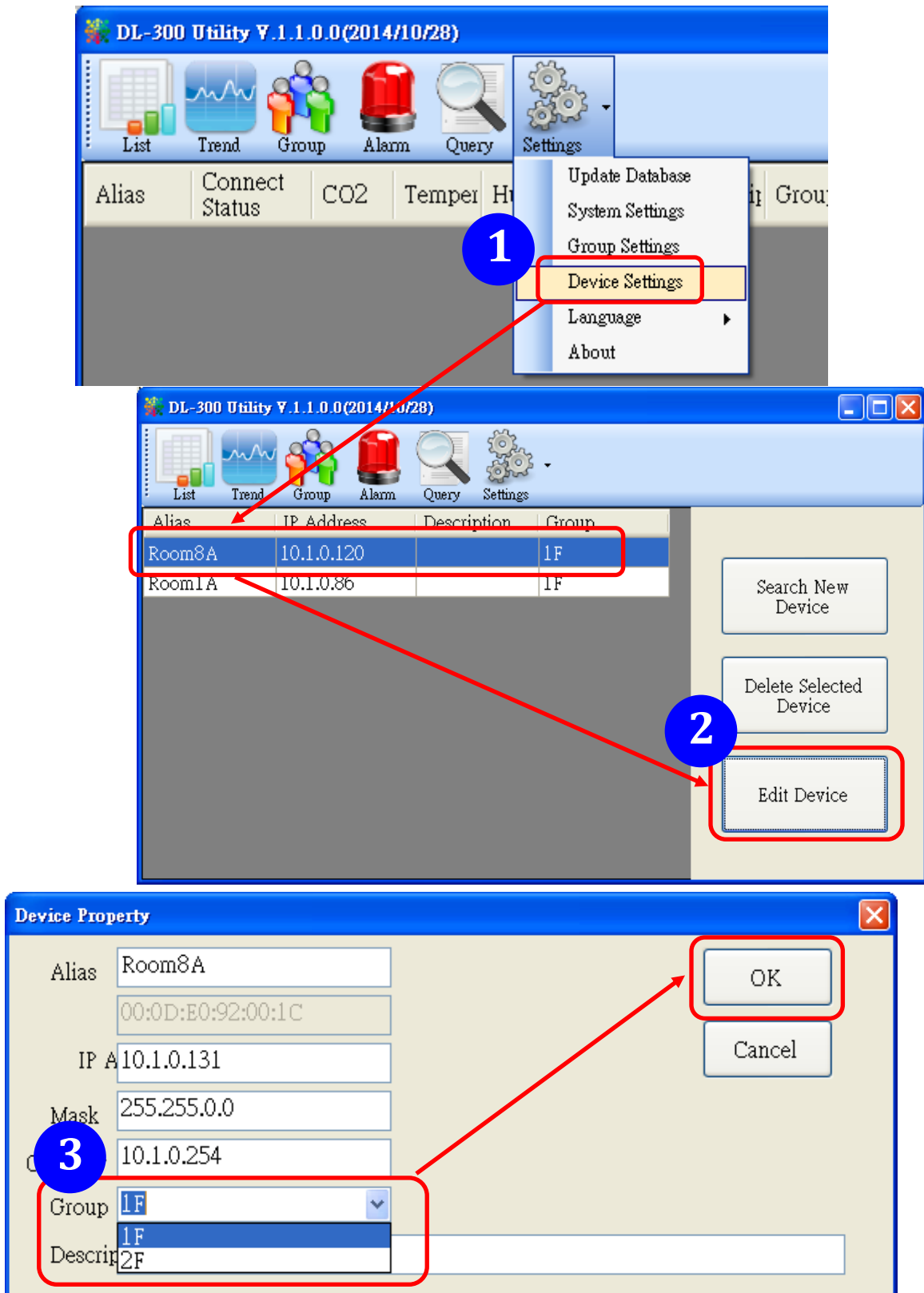

6-4. Monitor the group data by clicking the **Group** icon and then highlighting the group name.

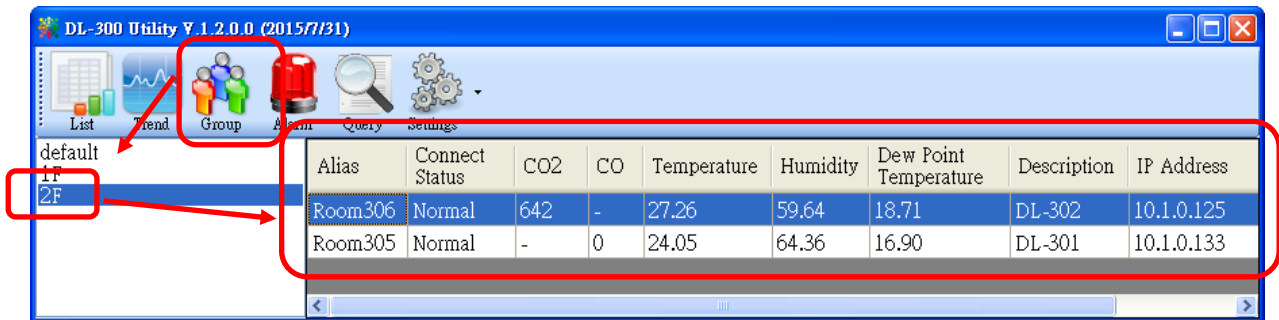

---

## 7. FAQ

### **Q1: What is ABC (Automatic Baseline Correction)?**

A: ABC stands for the Automatic Baseline Correction which is used to adjust a shifted baseline to the carbon dioxide level in fresh air. In case of normal indoor application, the carbon dioxide level drops to nearly outside air where there are no human, green plants or anything to elevate the carbon dioxide levels on weekday evenings or weekends, the ABC algorithm constantly keeps track of the lowest reading and slowly corrects it as the expected value in fresh air typically around 400 ppm.

### **Q2: Why I need to enable the ABC?**

A: When the CO<sub>2</sub> concentration detected in a period time of unoccupied space is greater than the base value of 400ppm, enable the ABC function to adjust the baseline. Be careful that the ABC will not work if a space is constantly occupied such as a hospital, 24-hr factory, 24-hr store, green house or other applications where CO<sub>2</sub> levels may be elevated at all times.

### **Q3: Does the DL-1022/DL-1023 enable the ABC as the factory default setting?**

A3: No, the ABC is default disabled in a DL-1022/DL-1023 logger to prevent the baseline from being adjusted to an incorrect value in case of using in a constantly occupied space.

### **Q4: What to do when the ABC is no work?**

A4: When the ABC is no work regarding baseline correction, the DL-1022/DL-1023 needs be returned to ICP DAS.



**Q5: How to set the password?**

A5: Enter the IP address for your DL-1000 logger in the address bar of a web browser and go to the Change Password page, enter the password in the New password and Confirm new password in the Change Touch Password field and then press the Submit button for change password. The password is numbers from 0 to 9 and up to 8 digits.

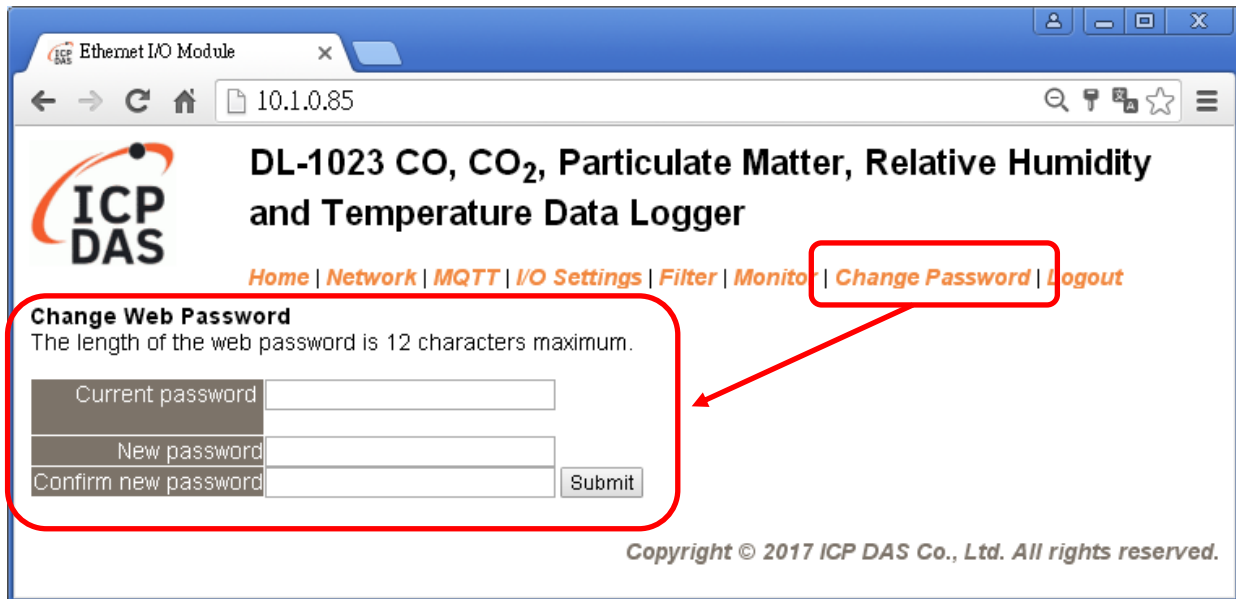

**Q6: How to cancel the password?**

A6: Enter the IP address for your logger in the address bar of a web browser and keep the New password and Confirm new password in field empty and then press the Submit button for change password.

### Q7: How to set the Accessible IP?

A7: Enter the IP address for your logger in the address bar of a web browser and go to the *Accessible IP Settings* page, select the radio button next to *Add \_\_\_\_\_.\_\_\_\_.\_\_\_\_.\_\_\_\_ To The List* and key in the IP for a device which is allowed to access the DL-1000, and then click the submit button.

Check the checkbox next to the *Save to Flash* before clicking the *submit* button to save the IP setting and use after repowering. Once any of those in the list is set, only the device for which the IP address is saved in the list can assess the DL-1000.

**Accessible IP Settings**

| Accessible IP List | IP Address |
|--------------------|------------|
| IP1                | 0.0.0.0    |
| IP2                | 0.0.0.0    |
| IP3                | 0.0.0.0    |
| IP4                | 0.0.0.0    |
| IP5                | 0.0.0.0    |

Add [ ] . [ ] . [ ] . [ ] To The List  
 Delete IP# [ ]  
 Delete ALL  
 Save to Flash

10.1.0.31/filter.html Copyright © 2014 ICP DAS Co., Ltd. All rights reserved.

### Q8: How to delete the Accessible IP settings?

A8: Enter the IP address for your logger in the address bar of a web browser and go to the *Accessible IP Settings* page, select the radio button next to *Delete IP#* to delete a IP by the IP number or select the radio button next tot *Delete All* and then click the submit button.

Check the checkbox next to the *Save to Flash* before clicking the *submit* button to save the IP setting and use after repowering.

**Accessible IP Settings**

| Accessible IP List | IP Address |
|--------------------|------------|
| IP1                | 0.0.0.0    |
| IP2                | 0.0.0.0    |
| IP3                | 0.0.0.0    |
| IP4                | 0.0.0.0    |
| IP5                | 0.0.0.0    |

Add [ ] . [ ] . [ ] . [ ] To The List  
 Delete IP# [ ]  
 Delete ALL  
 Save to Flash

10.1.0.31/filter.html Copyright © 2014 ICP DAS Co., Ltd. All rights reserved.

**Q9: How to clear the data logged in a DL-1000 module?**

A9: Enter the IP address for the module in the address bar of a web browser and go to the *I/O Settings* page, click the Reset Data Logger button at the bottom of the page.



**Q10 How to download firmware into a DL-1000 module?**

To update the Firmware for your DL-1000 module, connect DL-1000 module and PC in the same sub-network. Please note that there should be only one network card in the PC.

Download and install the eSearch utility.

<http://ftp.icpdas.com/pub/cd/usbcd/napdos/iiot/utility/esearch/>

Run the eSearch utility. Click on the Search Server button and it should find the DL-1000 module.

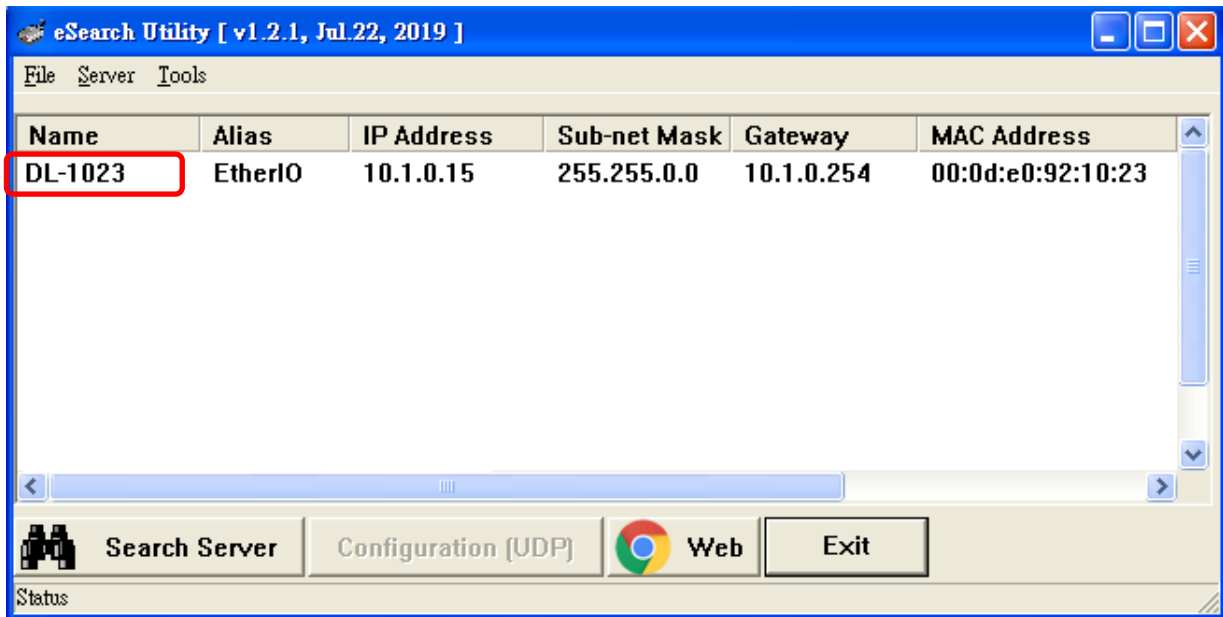

Right click on the DL-1000 module name then select Firmware Update.

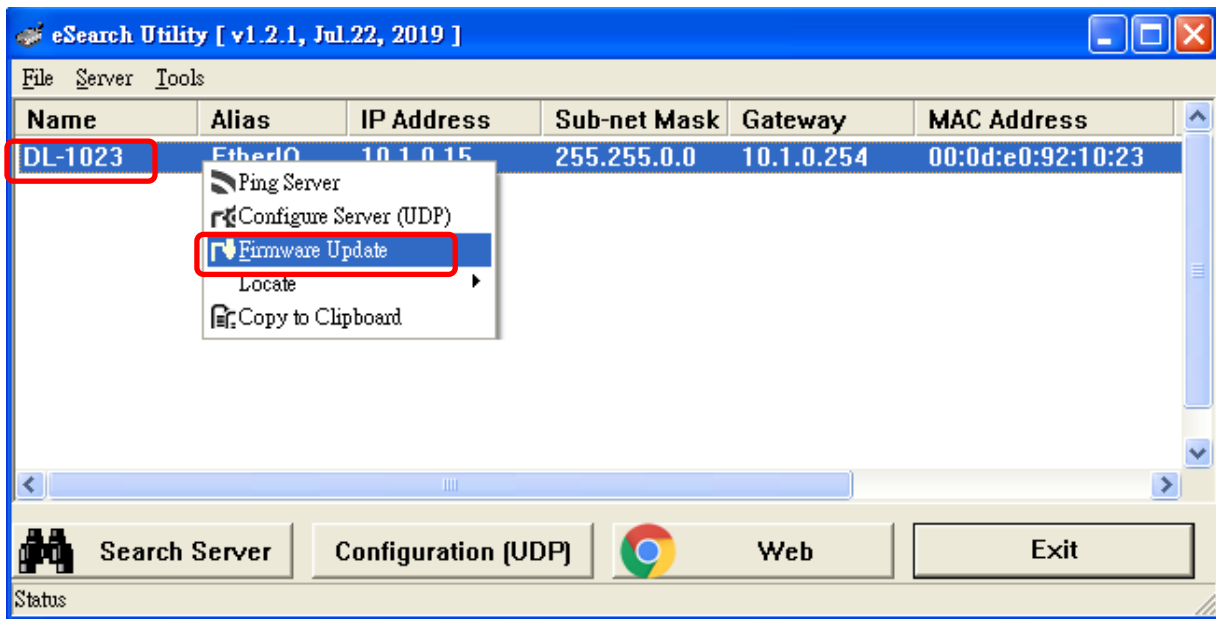

Select the firmware file and click on the Open button.

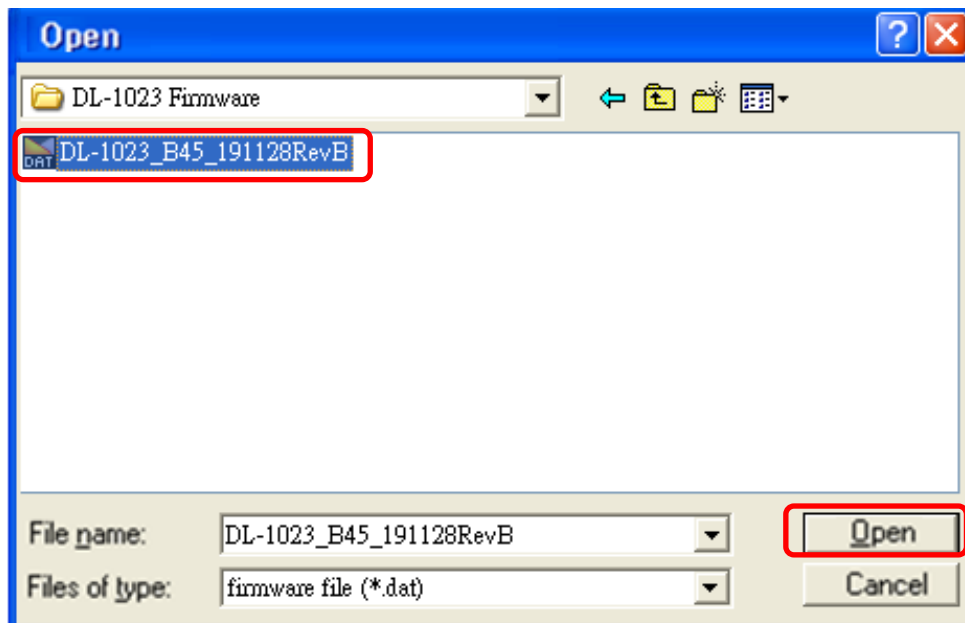

Make sure the IP address and MAC address are correct. Click on the OK button.

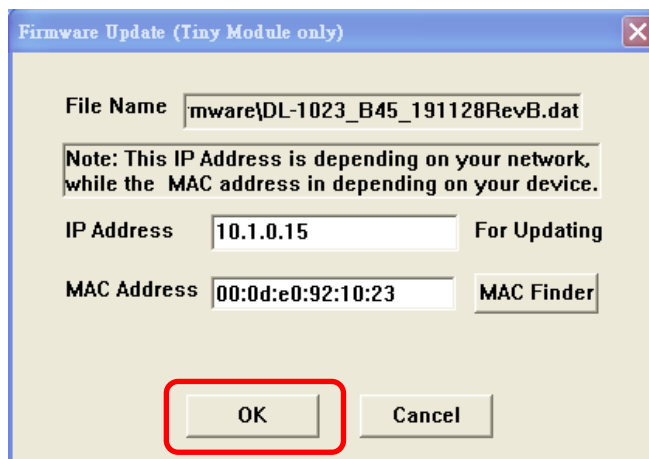

A command prompt window will be displayed to show the progress.

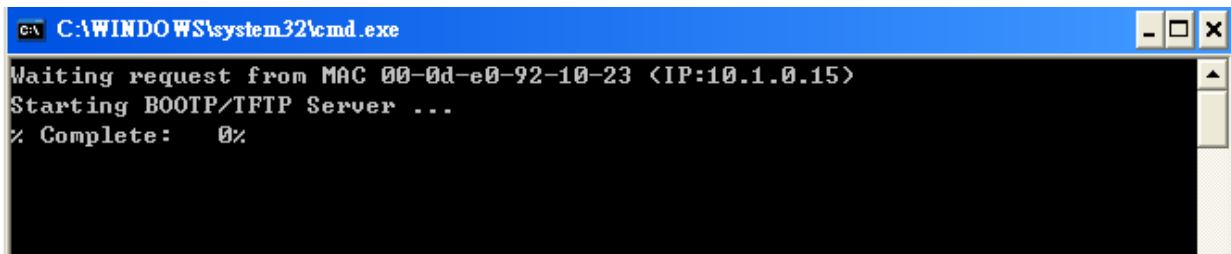

Log in the DL-1000 web page. Click on the Network tab then click on the Update button.

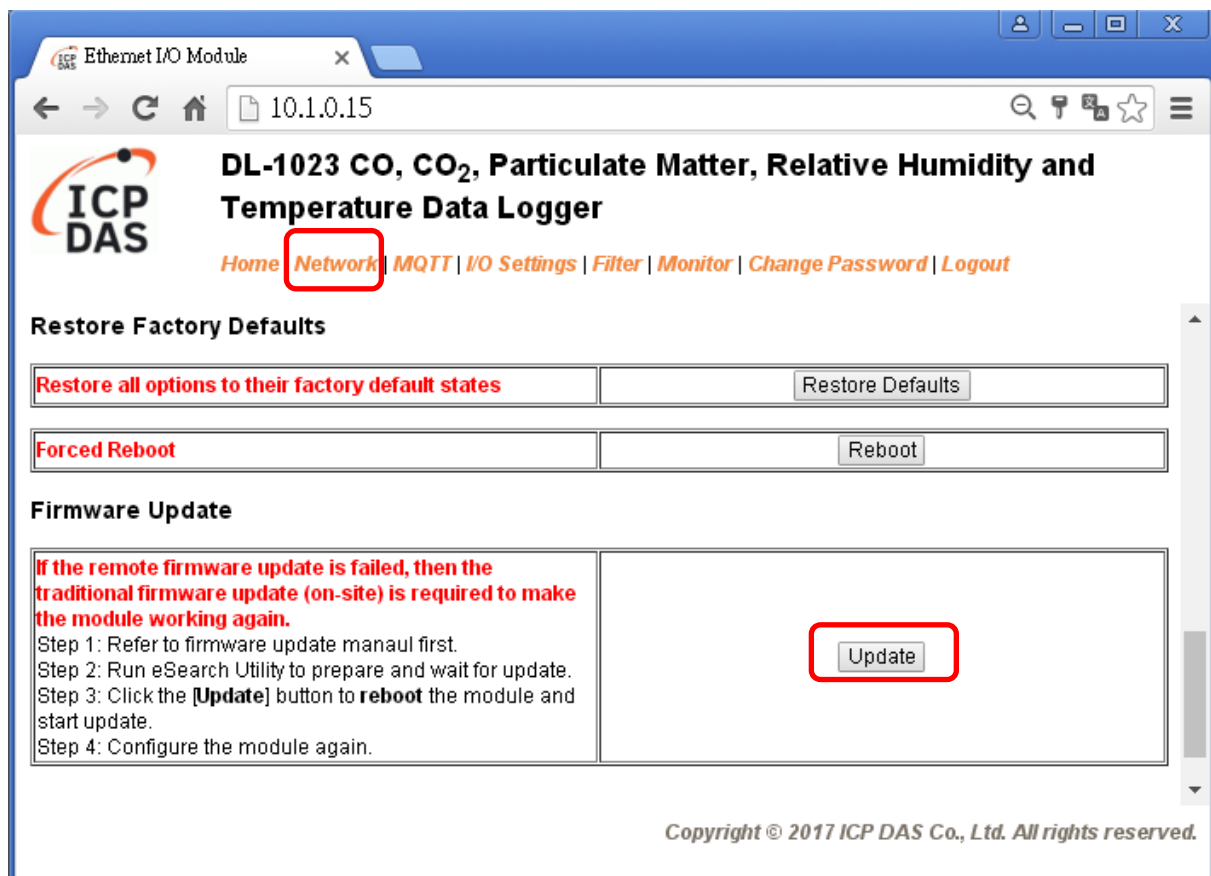

When it shows “% Complete: 100%”, the update is finished. You can close the command prompt window.

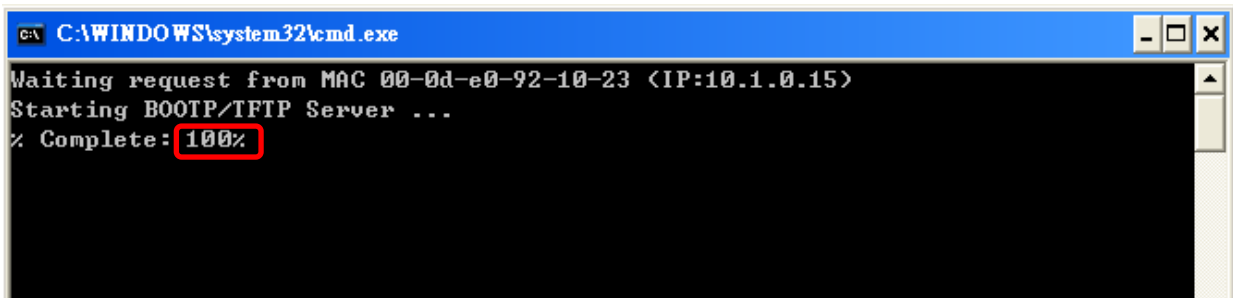

Re-log in the DL-1000 web page and check the firmware version.

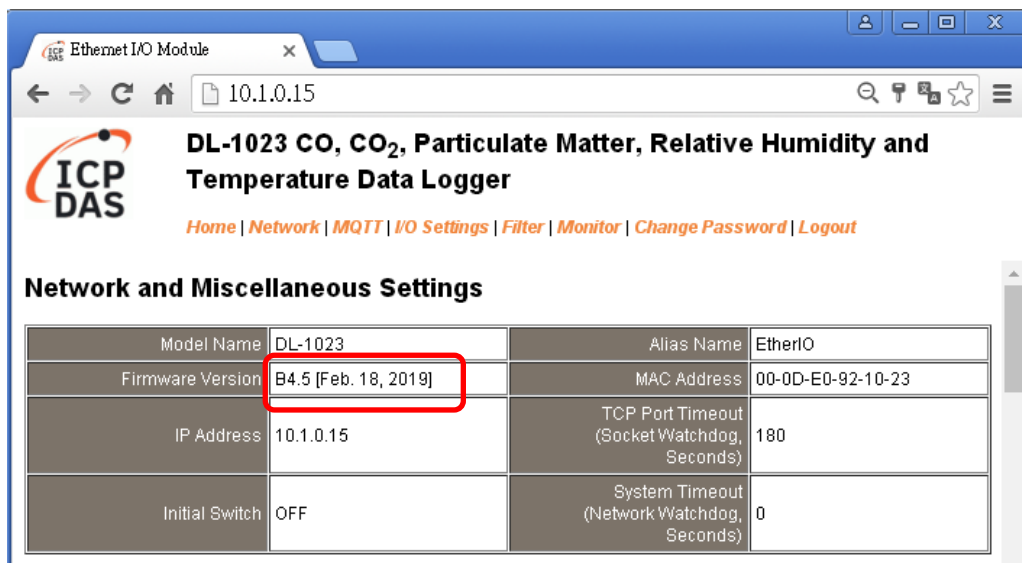

## Appendix A: DCON Command Sets

### A-1. DL-1020 DCON Command Sets

| Command     | Description  |
|-------------|--|
| \$AAF       | read firmware version  |
| \$AAI       | read INIT status<br>response:<br>!AA0 -> INIT short to GND<br>!AA1 -> else   |
| \$AAM       | read module name   |
| \$AAP       | Read Modbus RTU/DCON protocol<br>response:<br>!AA0 -> DCON<br>!AA1 -> Modbus RTU   |
| \$AAPN      | Set Modbus RTU/DCON protocol<br>N-> 0: DCON, 1: Modbus RTU   |
| \$AA2       | read configuration   |
| \$AA5       | read reset status<br>!AA1 first after power on, !AA0 others  |
| #AA         | Read All Analog Inputs<br>response<br>> (PM2.5 in 1 ug/m <sup>3</sup> ) (relative humidity in 0.01%)(temperature in 0.01°C)(temperature in 0.01°F) (dew point temperature in 0.01°C)(dew point temperature in 0.01°F) (PM1.0 in 1 ug/m <sup>3</sup> ) (PM10 in 1 ug/m <sup>3</sup> ) (particle count 0.3 - 0.5um) (particle count 0.5 - 1.0um) (particle count 1.0 - 2.5um) (particle count 2.5 - 5.0um) (particle count 5.0 - 7.5um) (particle count 7.5 - 10um)  |
| #AAN        | Read Channel Analog Input<br>N = 0 for PM2.5 in 1 ug/m <sup>3</sup> , 1 for relative humidity in 0.01%, 2 for temperature in 0.01°C, 3 for temperature in 0.01°F, 4 for dew point temperature in 0.01°C, 5 for dew point temperature in 0.01°F, 6 for PM1.0 in 1 ug/m <sup>3</sup> , 7 for PM10 in 1 ug/m <sup>3</sup> , 8 for particle count 0.3 - 0.5um, 9 for particle count 0.5 - 1.0um, A for particle count 1.0 - 2.5um, B for particle count 2.5 - 5.0um, C for particle count 5.0 - 7.5um, D for particle count 7.5 - 10um |
| %AANNTTCCFF | set configuration, NN: new address, TT = 00, CC: new baud rate<br>FF: data format  |
| @AABA       | Read beep on alarm time<br>response<br>!AAHH, HH in hex, 0: disabled, 1 ~ 250: beep on alarm time in seconds, 251: beep on alarm continuously  |

| <b>Command</b> | <b>Description</b>   |
|----------------|--|
| @AABAHH        | Set beep on alarm<br>HH in hex, 0: disabled, 1 ~ 250: beep on alarm time in seconds, 251: beep on alarm continuously   |
| @AABE          | Read enable/disable beep on alarm response<br>!AAHHHH, HHHH in hex, bit 0 for channel 0, bit 1 for channel 1, etc, for each bit, 0: disabled, 1: enabled   |
| @AABEH HHH     | Enable/disable beep on alarm<br>HHHH in hex, , bit 0 for channel 0, bit 1 for channel 1, etc, for each bit, 0: disabled, 1: enabled  |
| @AACH          | Clear all high latched analog inputs to the current values   |
| @AACHN         | Clear channel high latched analog input to the current value, N = 0 for PM2.5, 1 for relative humidity in 0.01%, 2 for temperature in 0.01°C, 3 for temperature in 0.01°F, 4 for dew point temperature in 0.01°C, 5 for dew point temperature in 0.01°F, 6 for PM1.0, 7 for PM10, 8 for particle count 0.3 - 0.5um, 9 for particle count 0.5 - 1.0um, A for particle count 1.0 - 2.5um, B for particle count 2.5 - 5.0um, C for particle count 5.0 - 7um, D for particle count 7.5 - 10um  |
| @AACHCN        | Clear high latched alarm of a channel, N = 0 for PM2.5, 1 for relative humidity in 0.01%, 2 for temperature in 0.01°C, 3 for temperature in 0.01°F, 4 for dew point temperature in 0.01°C, 5 for dew point temperature in 0.01°F, 6 for PM1.0, 7 for PM10, 8 for particle count 0.3 - 0.5um, 9 for particle count 0.5 - 1.0um, A for particle count 1.0 - 2.5um, B for particle count 2.5 - 5.0um, C for particle count 5.0 - 7.5um, D for particle count 7.5 - 10um                       |
| @AAACL         | Clear all low latched analog inputs to the current values  |
| @AAACLN        | Clear channel low latched analog input to the current value, N = 0 for PM2.5, 1 for relative humidity in 0.01%, 2 for temperature in 0.01°C, 3 for temperature in 0.01°F, 4 for dew point temperature in 0.01°C, 5 for dew point temperature in 0.01°F, 6 for PM1.0, 7 for PM10, 8 for particle count 0.3 - 0.5um, 9 for particle count 0.5 - 1.0um, A for particle count 1.0 - 2.5um, B for particle count 2.5 - 5.0um, C for particle count 5.0 - 7.5um, D for particle count 7.5 - 10um |
| @AAACLCN       | Clear low latched alarm of a channel, N = 1 for relative humidity, 2 for temperature in 0.01°C, 3 for temperature in 0.01°F, 4 for dew point temperature in 0.01°C, 5 for dew point temperature in 0.01°F  |
| @AADACN        | Disable AI alarm of a channel, N = 0 for PM2.5, 1 for relative humidity in 0.01%, 2 for temperature in 0.01°C, 3 for temperature in 0.01°F, 4 for dew point temperature in 0.01°C, 5 for dew point temperature in 0.01°F, 6 for PM1.0, 7 for PM10, 8 for particle count 0.3 - 0.5um, 9 for particle count 0.5 - 1.0um, A for particle count 1.0 - 2.5um, B for particle count 2.5 - 5.0um, C for particle count 5.0 - 7.5um, D for particle count 7.5 - 10um                               |
| @AADI          | read DO response<br>!AA00000, O: 0 ~ F, DO value in hex format   |



| <b>Command</b>        | <b>Description</b>   |
|-----------------------|--|
| @AADLB                | Read the beginning of the period setting of the data logger for period logging mode<br>response<br>!AAyyyymmddhhmmss,  |
| @AADLByyyyymmddhhmmss | Set the beginning of the period setting of the data logger for period logging mode<br>yyyy: year, 2000 to 2199, mm: month, 01 to 12, dd: date, 01 to 31, hh: hour, 0 to 24, mm: minute, 0 to 59, ss: second, 0 to 59   |
| @AADLC                | Read the data logger command<br>response<br>!AAh, 0: stop, 1: run, 2: run in period mode   |
| @AADLCh               | Set the data logger command, h->0: stop, 1: run, 2: run in period mode   |
| @AADLE                | Read the ending of the period setting of the data logger for period logging mode<br>response<br>!AAyyyymmddhhmmss  |
| @AADLEyyyymmddhhmmss  | Set the ending of the period setting of the data logger for period logging mode<br>yyyy: year, 2000 to 2199, mm: month, 01 to 12, dd: date, 01 to 31, hh: hour, 0 to 24, mm: minute, 0 to 59, ss: second, 0 to 59  |
| @AADLN                | Read number of log records in the data logger<br>response<br>!AAhhhhhhhh, hhhhhhhh in hex format   |
| @AADLO                | Read the overwriting mode when data logger is full<br>response<br>!AAh, 0: stop logging when full, 1: overwrite  |
| @AADLOh               | Set the overwriting mode when data logger is full<br>h->0: stop logging when full, 1: overwrite  |
| @AADLP                | Read the samplig period setting of the data logger<br>response<br>!AAhhmmss, hh: hour, 0 to 24, mm: minute, 0 to 59, ss: second, 0 to 59   |
| @AADLPPhmmss          | Set the samplig period setting of the data logger  |
| @AADLS                | Read logging status of the data logger<br>response<br>!AAhh, hh in hex format, 00: stopped, 01: running, others: error   |
| @AADO0V               | set DO, V-> 0 ~ F DO value in hex format, bit 0 for DO0, bit 1 for DO1, etc  |
| @AAEATCN              | Enable AI alarm of a channel, N = 0 for PM2.5, 1 for relative humidity in 0.01%, 2 for temperature in 0.01°C, 3 for temperature in 0.01°F, 4 for dew point temperature in 0.01°C, 5 for dew point temperature in 0.01°F, 6 for PM1.0, 7 for PM10, 8 for particle count 0.3 - 0.5um, 9 for particle count 0.5 - 1.0um, A for particle count 1.0 - 2.5um, B for particle count 2.5 - 5.0um, C for particle count 5.0 - 7.5um, D for particle count 7.5 - 10um<br>T->M: momentary alarm, L: latched alarm |
| @AAFN                 | Read fan status<br>Response<br>!AAE, E=0: fan off, 1: fan on,  |

| <b>Command</b>        | <b>Description</b>  |
|-----------------------|---|
| @AAFNE                | Turn fan on or off<br>E=0: fan off, 1: fan on   |
| @AAFNPi               | Read the ith fan off period in a day, i = 0 to 5<br>response<br>!AAbhbmehem, bh: beginning hour, bm: beginning minute, eh:<br>ending hour, em: ending minute.   |
| @AAFNPibhbmehem       | Set the ith fan off period in a day, i = 0 to 5, bh: beginning hour, 0 to 23,<br>bm: beginning minute, 0 to 59, eh: ending hour, 0 to 23, em: ending<br>minute, 0 to 59. The beginning hour/minute should be earlier than the<br>ending hour/minute. Otherwise, the setting is ignored. If all of the six<br>period settings are invalid, then the fan is controlled by the @AAFNE<br>command.  |
| @AAHI(data)CN         | Set high alarm limit of an AI channel, N = 0 for PM2.5, 1 for relative<br>humidity in 0.01%, 2 for temperature in 0.01°C, 3 for temperature in 0.01°<br>F, 4 for dew point temperature in 0.01°C, 5 for dew point temperature in<br>0.01°F, 6 for PM1.0, 7 for PM10, 8 for particle count 0.3 - 0.5um, 9 for<br>particle count 0.5 - 1.0um, A for particle count 1.0 - 2.5um, B for particle<br>count 2.5 - 5.0um, C for particle count 5.0 - 7.5um, D for particle count<br>7.5 - 10um |
| @AAHO                 | Read humidity offset  |
| @AAHO(data)           | Set humidity offset, data in format of -100.00 ~ +100.00  |
| @AALO(data)CN         | Set low alarm limit of an AI channel, N = 1 for relative humidity in<br>0.01%, 2 for temperature in 0.01°C, 3 for temperature in 0.01°F, 4 for dew<br>point temperature in 0.01°C, 5 for dew point temperature in 0.01°F  |
| @AAPO                 | Read PM2.5 offset   |
| @AAPO(data)           | Set PM2.5 offset, data in format of -00100. ~ +00100.   |
| @AAP1O                | Read PM1.0 offset   |
| @AAP1O(data)          | Set PM1.0 offset, data in format of -00100. ~ +00100.   |
| @AAP10O               | Read PM10 offset  |
| @AAP10O(data)         | Set PM10 offset, data in format of -00100. ~ +00100.  |
| @AARACN               | Read AI alarm enabled/disabled status of a channel<br>response<br>!AAN, N->0: disabled, 1: momentary, 2: latched  |
| @AARAO                | Read AI alarm status<br>response<br>!AAHHHLLLL  |
| @AARHN                | Read channel high latched value of analog input   |
| @AARHCN               | Read high alarm limit of an AI channel  |
| @AARL                 | Read all low latched values of analog input channels  |
| @AARLN                | Read channel low latched value of analog input  |
| @AARLCN               | Read low alarm limit of an AI channel   |
| @AART                 | Read RTC data   |
| @AARTYYMMD<br>DHHMMSS | Set RTC data  |
| @AATO                 | Read temperature offset in 0.01°C   |

| <b>Command</b> | <b>Description</b>   |
|----------------|--|
| @AATO(data)    | Set temperature offset in 0.01°C, -100.00 ~ +100.00  |
| ~**            | clear host watchdog timeout counter  |
| ~AA0           | read host watchdog status  |
| ~AA1           | clear host watchdog timeout status   |
| ~AA2           | read host watchdog enable/disable status and timeout value   |
| ~AA3ETT        | enable/disable host watchdog and set timeout value<br>E-> 0: disable host watchdog, 1: enable host watchdog<br>TT: host watchdog timeout in 0.1s in hex format |
| ~AA4           | read DO power on and safe value  |
| ~AA5P0S        | set DO power on and safe value<br>P-> 0 ~ F: power on value in hex format<br>S-> 0 ~ F: safe value in hex format   |
| ~AARD          | read response delay time in ms in hex format   |
| ~AARDVV        | set response delay time in ms, VV in hex format, 00 - 1E   |

## Baud Rate Setting (CC)

Bits 5:0

Baud rate, 0x03 ~ 0x0A

|      |       |       |       |        |
|------|-------|-------|-------|--------|
| Code | 0x03  | 0x04  | 0x05  | 0x06   |
| Baud | 1200  | 2400  | 4800  | 9600   |
| Code | 0x07  | 0x08  | 0x09  | 0x0A   |
| Baud | 19200 | 38400 | 57600 | 115200 |

Bits 7:6

00: no parity, 1 stop bit

01: no parity, 2 stop bits

10: even parity, 1 stop bit

11: odd parity, 1 stop bit

## Data Format Setting (FF)

Bit 6

0: checksum disabled

1: checksum enabled

## A-2. DL-1021 DCON Command Sets

| Command     | Description   |
|-------------|---|
| \$AAF       | read firmware version   |
| \$AAI       | read INIT status<br>response:<br>!AA0 -> INIT short to GND<br>!AA1 -> else  |
| \$AAM       | read module name  |
| \$AAP       | Read Modbus RTU/DCON protocol<br>response:<br>!AA0 -> DCON<br>!AA1 -> Modbus RTU  |
| \$AAPN      | Set Modbus RTU/DCON protocol<br>N-> 0: DCON, 1: Modbus RTU  |
| \$AA2       | read configuration  |
| \$AA5       | read reset status<br>!AA1 first after power on, !AA0 others   |
| #AA         | Read All Analog Inputs<br>response<br>> (CO in 1 ppm) (PM2.5 in 1 ug/m <sup>3</sup> ) (relative humidity in 0.01%)(temperature in 0.01°C)(temperature in 0.01°F) (dew point temperature in 0.01°C)(dew point temperature in 0.01°F) (PM1.0 in 1 ug/m <sup>3</sup> ) (PM10 in 1 ug/m <sup>3</sup> ) (particle count 0.3 - 0.5um) (particle count 0.5 - 1.0um) (particle count 1.0 - 2.5um) (particle count 2.5 - 5.0um) (particle count 5.0 - 7.5um) (particle count 7.5 - 10um)   |
| #AAN        | Read Channel Analog Input<br>N = 0 for CO in 1 ppm, 1 for PM2.5 in 1 ug/m <sup>3</sup> , 2 for relative humidity in 0.01%, 3 for temperature in 0.01°C, 4 for temperature in 0.01°F, 5 for dew point temperature in 0.01°C, 6 for dew point temperature in 0.01°F, 7 for PM1.0 in 1 ug/m <sup>3</sup> , 8 for PM10 in 1 ug/m <sup>3</sup> , 9 for particle count 0.3 - 0.5um, A for particle count 0.5 - 1.0um, B for particle count 1.0 - 2.5um, C for particle count 2.5 - 5.0um, D for particle count 5.0 - 7.5um, E for particle count 7.5 - 10um |
| %AANNTTCCFF | set configuration, NN: new address, TT = 00, CC: new baud rate<br>FF: data format   |
| @AABA       | Read beep on alarm time<br>response<br>!AAHH, HH in hex, 0: disabled, 1 ~ 250: beep on alarm time in seconds, 251: beep on alarm continuously   |
| @AABAHH     | Set beep on alarm<br>HH in hex, 0: disabled, 1 ~ 250: beep on alarm time in seconds, 251: beep on alarm continuously  |
| @AABE       | Read enable/disable beep on alarm<br>response<br>!AAHHHH, HHHH in hex, bit 0 for channel 0, bit 1 for channel 1, etc, for each bit, 0: disabled, 1: enabled   |
| @AABEHHHH   | Enable/disable beep on alarm<br>HHHH in hex, , bit 0 for channel 0, bit 1 for channel 1, etc, for each bit, 0: disabled, 1: enabled   |

| <b>Command</b>       | <b>Description</b>  |
|----------------------|---|
| @AACH                | Clear all high latched analog inputs to the current values  |
| @AACHN               | Clear channel high latched analog input to the current value, N = 0 for CO, 1 for PM2.5, 2 for relative humidity in 0.01%, 3 for temperature in 0.01°C, 4 for temperature in 0.01°F, 5 for dew point temperature in 0.01°C, 6 for dew point temperature in 0.01°F, 7 for PM1.0, 8 for PM10, 9 for particle count 0.3 - 0.5um, A for particle count 0.5 - 1.0um, B for particle count 1.0 - 2.5um, C for particle count 2.5 - 5.0um, D for particle count 5.0 - 7.5um, E for particle count 7.5 - 10um |
| @AACHCN              | Clear high latched alarm of a channel, N = 0 for CO, 1 for PM2.5, 2 for relative humidity in 0.01%, 3 for temperature in 0.01°C, 4 for temperature in 0.01°F, 5 for dew point temperature in 0.01°C, 6 for dew point temperature in 0.01°F, 7 for PM1.0, 8 for PM10, 9 for particle count 0.3 - 0.5um, A for particle count 0.5 - 1.0um, B for particle count 1.0 - 2.5um, C for particle count 2.5 - 5.0um, D for particle count 5.0 - 7.5um, E for particle count 7.5 - 10um                        |
| @AACL                | Clear all low latched analog inputs to the current values   |
| @AACLN               | Clear channel low latched analog input to the current value, N = 0 for CO, 1 for PM2.5, 2 for relative humidity in 0.01%, 3 for temperature in 0.01°C, 4 for temperature in 0.01°F, 5 for dew point temperature in 0.01°C, 6 for dew point temperature in 0.01°F, 7 for PM1.0, 8 for PM10, 9 for particle count 0.3 - 0.5um, A for particle count 0.5 - 1.0um, B for particle count 1.0 - 2.5um, C for particle count 2.5 - 5.0um, D for particle count 5.0 - 7.5um, E for particle count 7.5 - 10um  |
| @AACLN               | Clear low latched alarm of a channel, N = 2 for relative humidity, 3 for temperature in 0.01°C, 4 for temperature in 0.01°F, 5 for dew point temperature in 0.01°C, 6 for dew point temperature in 0.01°F   |
| @AADACN              | Disable AI alarm of a channel, N = 0 for CO, 1 for PM2.5, 2 for relative humidity in 0.01%, 3 for temperature in 0.01°C, 4 for temperature in 0.01°F, 5 for dew point temperature in 0.01°C, 6 for dew point temperature in 0.01°F, 7 for PM1.0, 8 for PM10, 9 for particle count 0.3 - 0.5um, A for particle count 0.5 - 1.0um, B for particle count 1.0 - 2.5um, C for particle count 2.5 - 5.0um, D for particle count 5.0 - 7.5um, E for particle count 7.5 - 10um                                |
| @AADI                | read DO<br>response<br>!AA0000, O: 0 ~ F, DO value in hex format  |
| @AADLB               | Read the beginning of the period setting of the data logger for period logging mode<br>response<br>!AAyyyymmddhhmmss,   |
| @AADLByyyymmddhhmmss | Set the beginning of the period setting of the data logger for period logging mode<br>yyyy: year, 2000 to 2199, mm: month, 01 to 12, dd: date, 01 to 31, hh: hour, 0 to 24, mm: minute, 0 to 59, ss: second, 0 to 59  |

| <b>Command</b>       | <b>Description</b>   |
|----------------------|--|
| @AADLC               | Read the data logger command response<br>!AAh, 0: stop, 1: run, 2: run in period mode  |
| @AADLCh              | Set the data logger command, h->0: stop, 1: run, 2: run in period mode   |
| @AADLE               | Read the ending of the period setting of the data logger for period logging mode response<br>!AAyyyymmddhhmmss   |
| @AADLEyyyymmddhhmmss | Set the ending of the period setting of the data logger for period logging mode<br>yyyy: year, 2000 to 2199, mm: month, 01 to 12, dd: date, 01 to 31, hh: hour, 0 to 24, mm: minute, 0 to 59, ss: second, 0 to 59  |
| @AADLN               | Read number of log records in the data logger response<br>!AAhhhhhhhh, hhhhhhhh in hex format  |
| @AADLO               | Read the overwriting mode when data logger is full response<br>!AAh, 0: stop logging when full, 1: overwrite   |
| @AADLOh              | Set the overwriting mode when data logger is full<br>h->0: stop logging when full, 1: overwrite  |
| @AADLP               | Read the samplig period setting of the data logger response<br>!AAhhmmss, hh: hour, 0 to 24, mm: minute, 0 to 59, ss: second, 0 to 59  |
| @AADLPhmmss          | Set the samplig period setting of the data logger  |
| @AADLS               | Read logging status of the data logger response<br>!AAhh, hh in hex format, 00: stopped, 01: running, others: error  |
| @AADO0V              | set DO, V-> 0 ~ F DO value in hex format, bit 0 for DO0, bit 1 for DO1, etc  |
| @AAEATCN             | Enable AI alarm of a channel, N = 0 for CO, 1 for PM2.5, 2 for relative humidity in 0.01%, 3 for temperature in 0.01°C, 4 for temperature in 0.01°F, 5 for dew point temperature in 0.01°C, 6 for dew point temperature in 0.01°F, 7 for PM1.0, 8 for PM10, 9 for particle count 0.3 - 0.5um, A for particle count 0.5 - 1.0um, B for particle count 1.0 - 2.5um, C for particle count 2.5 - 5.0um, D for particle count 5.0 - 7.5um, E for particle count 7.5 - 10um<br>T->M: momentary alarm, L: latched alarm |
| @AAFN                | Read fan status<br>Response<br>!AAE, E=0: fan off, 1: fan on,  |
| @AAFNE               | Turn fan on or off<br>E=0: fan off, 1: fan on  |
| @AAFNPi              | Read the ith fan off period in a day, i = 0 to 5 response<br>!AAbhbmehem, bh: beginning hour, bm: beginning minute, eh: ending hour, em: ending minute.  |

| <b>Command</b>        | <b>Description</b>   |
|-----------------------|--|
| @AAFNPibhbmeh<br>em   | Set the ith fan off period in a day, i = 0 to 5, bh: beginning hour, 0 to 23, bm: beginning minute, 0 to 59, eh: ending hour, 0 to 23, em: ending minute, 0 to 59. The beginning hour/minute should be earlier than the ending hour/minute. Otherwise, the setting is ignored. If all of the six period settings are invalid, then the fan is controlled by the @AAFNE command.  |
| @AAHI(data)CN         | Set high alarm limit of an AI channel, N = 0 for CO, 1 for PM2.5, 2 for relative humidity in 0.01%, 3 for temperature in 0.01°C, 4 for temperature in 0.01°F, 5 for dew point temperature in 0.01°C, 6 for dew point temperature in 0.01°F, 7 for PM1.0, 8 for PM10, 9 for particle count 0.3 - 0.5um, A for particle count 0.5 - 1.0um, B for particle count 1.0 - 2.5um, C for particle count 2.5 - 5.0um, D for particle count 5.0 - 7.5um, E for particle count 7.5 - 10um |
| @AAHO                 | Read humidity offset   |
| @AAHO(data)           | Set humidity offset, data in format of -100.00 ~ +100.00   |
| @AALO(data)CN         | Set low alarm limit of an AI channel, N = 2 for relative humidity in 0.01%, 3 for temperature in 0.01°C, 4 for temperature in 0.01°F, 5 for dew point temperature in 0.01°C, 6 for dew point temperature in 0.01°F   |
| @AAPO                 | Read PM2.5 offset  |
| @AAPO(data)           | Set PM2.5 offset, data in format of -00100. ~ +00100.  |
| @AAP1O                | Read PM1.0 offset  |
| @AAP1O(data)          | Set PM1.0 offset, data in format of -00100. ~ +00100.  |
| @AAP10O               | Read PM10 offset   |
| @AAP10O(data)         | Set PM10 offset, data in format of -00100. ~ +00100.   |
| @AARACN               | Read AI alarm enabled/disabled status of a channel<br>response<br>!AAN, N->0: disabled, 1: momentary, 2: latched   |
| @AARAO                | Read AI alarm status<br>response<br>!AAHHHLLLL   |
| @AARH                 | Read all high latched values of analog input channels  |
| @AARHN                | Read channel high latched value of analog input  |
| @AARHCN               | Read high alarm limit of an AI channel   |
| @AARL                 | Read all low latched values of analog input channels   |
| @AARLN                | Read channel low latched value of analog input   |
| @AARLCN               | Read low alarm limit of an AI channel  |
| @AART                 | Read RTC data  |
| @AARTYYMMD<br>DHHMMSS | Set RTC data   |
| @AATO                 | Read temperature offset in 0.01°C  |
| @AATO(data)           | Set temperature offset in 0.01°C, -100.00 ~ +100.00  |
| ~**                   | clear host watchdog timeout counter  |
| ~AA0                  | read host watchdog status  |
| ~AA1                  | clear host watchdog timeout status   |
| ~AA2                  | read host watchdog enable/disable status and timeout value   |

| <b>Command</b> | <b>Description</b>   |
|----------------|--|
| ~AA3ETT        | enable/disable host watchdog and set timeout value<br>E-> 0: disable host watchdog, 1: enable host watchdog<br>TT: host watchdog timeout in 0.1s in hex format |
| ~AA4           | read DO power on and safe value  |
| ~AA50POS       | set DO power on and safe value<br>P-> 0 ~ F: power on value in hex format<br>S-> 0 ~ F: safe value in hex format   |
| ~AARD          | read response delay time in ms in hex format   |
| ~AARDVV        | set response delay time in ms, VV in hex format, 00 - 1E   |

## **Baud Rate Setting (CC)**

Bits 5:0

Baud rate, 0x03 ~ 0x0A

|      |       |       |       |        |
|------|-------|-------|-------|--------|
| Code | 0x03  | 0x04  | 0x05  | 0x06   |
| Baud | 1200  | 2400  | 4800  | 9600   |
| Code | 0x07  | 0x08  | 0x09  | 0x0A   |
| Baud | 19200 | 38400 | 57600 | 115200 |

Bits 7:6

00: no parity, 1 stop bit

01: no parity, 2 stop bits

10: even parity, 1 stop bit

11: odd parity, 1 stop bit

## **Data Format Setting (FF)**

Bit 6

0: checksum disabled

1: checksum enabled



### A-3. DL-1022 DCON Command Sets

| Command    | Description  |
|------------|--|
| \$AAF      | read firmware version  |
| \$AAI      | read INIT status<br>response:<br>!AA0 -> INIT short to GND<br>!AA1 -> else   |
| \$AAM      | read module name   |
| \$AAP      | Read Modbus RTU/DCON protocol<br>response:<br>!AA0 -> DCON<br>!AA1 -> Modbus RTU   |
| \$AAPN     | Set Modbus RTU/DCON protocol<br>N-> 0: DCON, 1: Modbus RTU   |
| \$AA2      | read configuration   |
| \$AA5      | read reset status<br>!AA1 first after power on, !AA0 others  |
| #AA        | Read All Analog Inputs<br>response<br>> (CO <sub>2</sub> in 1 ppm) (PM2.5 in 1 ug/m <sup>3</sup> ) (relative humidity in 0.01%)(temperature in 0.01°C)(temperature in 0.01°F) (dew point temperature in 0.01°C)(dew point temperature in 0.01°F) (PM1.0 in 1 ug/m <sup>3</sup> ) (PM10 in 1 ug/m <sup>3</sup> ) (particle count 0.3 - 0.5um) (particle count 0.5 - 1.0um) (particle count 1.0 - 2.5um) (particle count 2.5 - 5.0um) (particle count 5.0 - 7.5um) (particle count 7.5 - 10um)   |
| #AAN       | Read Channel Analog Input<br>N = 0 for CO <sub>2</sub> in 1 ppm, 1 for PM2.5 in 1 ug/m <sup>3</sup> , 2 for relative humidity in 0.01%, 3 for temperature in 0.01°C, 4 for temperature in 0.01°F, 5 for dew point temperature in 0.01°C, 6 for dew point temperature in 0.01°F, 7 for PM1.0 in 1 ug/m <sup>3</sup> , 8 for PM10 in 1 ug/m <sup>3</sup> , 9 for particle count 0.3 - 0.5um, A for particle count 0.5 - 1.0um, B for particle count 1.0 - 2.5um, C for particle count 2.5 - 5.0um, D for particle count 5.0 - 7.5um, E for particle count 7.5 - 10um |
| %AANNTTCFF | set configuration, NN: new address, TT = 00, CC: new baud rate<br>FF: data format  |
| @AAABC     | Read status of the automatic baseline correction<br>response<br>!AAN, N=0: disabled, 1: enabled  |
| @AAABCN    | Set the automatic baseline correction<br>N->0: disabled, 1: enabled  |
| @AABA      | Read beep on alarm time<br>response<br>!AAHH, HH in hex, 0: disabled, 1 ~ 250: beep on alarm time in seconds, 251: beep on alarm continuously  |
| @AABAHH    | Set beep on alarm<br>HH in hex, 0: disabled, 1 ~ 250: beep on alarm time in seconds, 251: beep on alarm continuously   |

| <b>Command</b> | <b>Description</b>  |
|----------------|---|
| @AABE          | Read enable/disable beep on alarm response<br>!AAHHHH, HHHH in hex, bit 0 for channel 0, bit 1 for channel 1, etc, for each bit, 0: disabled, 1: enabled  |
| @AABEHHHH      | Enable/disable beep on alarm<br>HHHH in hex, , bit 0 for channel 0, bit 1 for channel 1, etc, for each bit, 0: disabled, 1: enabled   |
| @AACH          | Clear all high latched analog inputs to the current values  |
| @AACHN         | Clear channel high latched analog input to the current value, N = 0 for CO <sub>2</sub> , 1 for PM2.5, 2 for relative humidity in 0.01%, 3 for temperature in 0.01°C, 4 for temperature in 0.01°F, 5 for dew point temperature in 0.01°C, 6 for dew point temperature in 0.01°F, 7 for PM1.0, 8 for PM10, 9 for particle count 0.3 - 0.5um, A for particle count 0.5 - 1.0um, B for particle count 1.0 - 2.5um, C for particle count 2.5 - 5.0um, D for particle count 5.0 - 7.5um, E for particle count 7.5 - 10um |
| @AACHCN        | Clear high latched alarm of a channel, N = 0 for CO <sub>2</sub> , 1 for PM2.5, 2 for relative humidity in 0.01%, 3 for temperature in 0.01°C, 4 for temperature in 0.01°F, 5 for dew point temperature in 0.01°C, 6 for dew point temperature in 0.01°F, 7 for PM1.0, 8 for PM10, 9 for particle count 0.3 - 0.5um, A for particle count 0.5 - 1.0um, B for particle count 1.0 - 2.5um, C for particle count 2.5 - 5.0um, D for particle count 5.0 - 7.5um, E for particle count 7.5 - 10um                        |
| @AACL          | Clear all low latched analog inputs to the current values   |
| @AACLN         | Clear channel low latched analog input to the current value, N = 0 for CO <sub>2</sub> , 1 for PM2.5, 2 for relative humidity in 0.01%, 3 for temperature in 0.01°C, 4 for temperature in 0.01°F, 5 for dew point temperature in 0.01°C, 6 for dew point temperature in 0.01°F, 7 for PM1.0, 8 for PM10, 9 for particle count 0.3 - 0.5um, A for particle count 0.5 - 1.0um, B for particle count 1.0 - 2.5um, C for particle count 2.5 - 5.0um, D for particle count 5.0 - 7.5um, E for particle count 7.5 - 10um  |
| @AACL CN       | Clear low latched alarm of a channel, N = 2 for relative humidity, 3 for temperature in 0.01°C, 4 for temperature in 0.01°F, 5 for dew point temperature in 0.01°C, 6 for dew point temperature in 0.01°F   |
| @AADACN        | Disable AI alarm of a channel, N = 0 for CO <sub>2</sub> , 1 for PM2.5, 2 for relative humidity in 0.01%, 3 for temperature in 0.01°C, 4 for temperature in 0.01°F, 5 for dew point temperature in 0.01°C, 6 for dew point temperature in 0.01°F, 7 for PM1.0, 8 for PM10, 9 for particle count 0.3 - 0.5um, A for particle count 0.5 - 1.0um, B for particle count 1.0 - 2.5um, C for particle count 2.5 - 5.0um, D for particle count 5.0 - 7.5um, E for particle count 7.5 - 10um                                |
| @AADI          | read DO response<br>!AA00000, O: 0 ~ F, DO value in hex format  |
| @AADLB         | Read the beginning of the period setting of the data logger for period logging mode response<br>!Ayyyymmddhhmmss,   |

| <b>Command</b>       | <b>Description</b>   |
|----------------------|--|
| @AADLByyyymmddhhmmss | Set the beginning of the period setting of the data logger for period logging mode<br>yyyy: year, 2000 to 2199, mm: month, 01 to 12, dd: date, 01 to 31, hh: hour, 0 to 24, mm: minute, 0 to 59, ss: second, 0 to 59   |
| @AADLC               | Read the data logger command response<br>!AAh, 0: stop, 1: run, 2: run in period mode  |
| @AADLCh              | Set the data logger command, h->0: stop, 1: run, 2: run in period mode   |
| @AADLE               | Read the ending of the period setting of the data logger for period logging mode response<br>!Ayyyymmddhhmmss  |
| @AADLEyyyymmddhhmmss | Set the ending of the period setting of the data logger for period logging mode<br>yyyy: year, 2000 to 2199, mm: month, 01 to 12, dd: date, 01 to 31, hh: hour, 0 to 24, mm: minute, 0 to 59, ss: second, 0 to 59  |
| @AADLN               | Read number of log records in the data logger response<br>!AAhhhhhhh, hhhhhhhh in hex format   |
| @AADLO               | Read the overwriting mode when data logger is full response<br>!AAh, 0: stop logging when full, 1: overwrite   |
| @AADLOh              | Set the overwriting mode when data logger is full<br>h->0: stop logging when full, 1: overwrite  |
| @AADLP               | Read the samplig period setting of the data logger response<br>!AAhhmmss, hh: hour, 0 to 24, mm: minute, 0 to 59, ss: second, 0 to 59  |
| @AADLPPhmmss         | Set the samplig period setting of the data logger  |
| @AADLS               | Read logging status of the data logger response<br>!AAhh, hh in hex format, 00: stopped, 01: running, others: error  |
| @AADO0V              | set DO, V-> 0 ~ F DO value in hex format, bit 0 for DO0, bit 1 for DO1, etc  |
| @AAEATCN             | Enable AI alarm of a channel, N = 0 for CO <sub>2</sub> , 1 for PM2.5, 2 for relative humidity in 0.01%, 3 for temperature in 0.01°C, 4 for temperature in 0.01°F, 5 for dew point temperature in 0.01°C, 6 for dew point temperature in 0.01°F, 7 for PM1.0, 8 for PM10, 9 for particle count 0.3 - 0.5um, A for particle count 0.5 - 1.0um, B for particle count 1.0 - 2.5um, C for particle count 2.5 - 5.0um, D for particle count 5.0 - 7.5um, E for particle count 7.5 - 10um<br>T->M: momentary alarm, L: latched alarm |
| @AAFN                | Read fan status<br>Response<br>!AAE, E=0: fan off, 1: fan on,  |
| @AAFNE               | Turn fan on or off<br>E=0: fan off, 1: fan on  |

| <b>Command</b>        | <b>Description</b>   |
|-----------------------|--|
| @AAFNPi               | Read the ith fan off period in a day, i = 0 to 5<br>response<br>!AAbhbmehem, bh: beginning hour, bm: beginning minute, eh:<br>ending hour, em: ending minute.  |
| @AAFNPibhbmehem       | Set the ith fan off period in a day, i = 0 to 5, bh: beginning hour, 0 to 23,<br>bm: beginning minute, 0 to 59, eh: ending hour, 0 to 23, em: ending<br>minute, 0 to 59. The beginning hour/minute should be earlier than the<br>ending hour/minute. Otherwise, the setting is ignored. If all of the six<br>period settings are invalid, then the fan is controlled by the @AAFNE<br>command.   |
| @AAHI(data)CN         | Set high alarm limit of an AI channel, N = 0 for CO <sub>2</sub> , 1 for PM2.5, 2 for<br>relative humidity in 0.01%, 3 for temperature in 0.01°C, 4 for temperature<br>in 0.01°F, 5 for dew point temperature in 0.01°C, 6 for dew point<br>temperature in 0.01°F, 7 for PM1.0, 8 for PM10, 9 for particle count 0.3 -<br>0.5um, A for particle count 0.5 - 1.0um, B for particle count 1.0 - 2.5um, C<br>for particle count 2.5 - 5.0um, D for particle count 5.0 - 7.5um, E for<br>particle count 7.5 - 10um |
| @AAHO                 | Read humidity offset   |
| @AAHO(data)           | Set humidity offset, data in format of -100.00 ~ +100.00   |
| @AALO(data)CN         | Set low alarm limit of an AI channel, N = 2 for relative humidity in<br>0.01%, 3 for temperature in 0.01°C, 4 for temperature in 0.01°F, 5 for dew<br>point temperature in 0.01°C, 6 for dew point temperature in 0.01°F   |
| @AAPO                 | Read PM2.5 offset  |
| @AAPO(data)           | Set PM2.5 offset, data in format of -00100. ~ +00100.  |
| @AAP1O                | Read PM1.0 offset  |
| @AAP1O(data)          | Set PM1.0 offset, data in format of -00100. ~ +00100.  |
| @AAP10O               | Read PM10 offset   |
| @AAP10O(data)         | Set PM10 offset, data in format of -00100. ~ +00100.   |
| @AARACN               | Read AI alarm enabled/disabled status of a channel<br>response<br>!AAN, N->0: disabled, 1: momentary, 2: latched   |
| @AARAO                | Read AI alarm status<br>response<br>!AAHHHLLLL   |
| @AARH                 | Read all high latched values of analog input channels  |
| @AARHN                | Read channel high latched value of analog input  |
| @AARHCN               | Read high alarm limit of an AI channel   |
| @AARL                 | Read all low latched values of analog input channels   |
| @AARLN                | Read channel low latched value of analog input   |
| @AARLCN               | Read low alarm limit of an AI channel  |
| @AART                 | Read RTC data  |
| @AARTYYMMD<br>DHHMMSS | Set RTC data   |
| @AATO                 | Read temperature offset in 0.01°C  |
| @AATO(data)           | Set temperature offset in 0.01°C, -100.00 ~ +100.00  |

| Command  | Description  |
|----------|--|
| ~**      | clear host watchdog timeout counter  |
| ~AA0     | read host watchdog status  |
| ~AA1     | clear host watchdog timeout status   |
| ~AA2     | read host watchdog enable/disable status and timeout value   |
| ~AA3ETT  | enable/disable host watchdog and set timeout value<br>E-> 0: disable host watchdog, 1: enable host watchdog<br>TT: host watchdog timeout in 0.1s in hex format |
| ~AA4     | read DO power on and safe value  |
| ~AA50P0S | set DO power on and safe value<br>P-> 0 ~ F: power on value in hex format<br>S-> 0 ~ F: safe value in hex format   |
| ~AARD    | read response delay time in ms in hex format   |
| ~AARDVV  | set response delay time in ms, VV in hex format, 00 - 1E   |

### Baud Rate Setting (CC)

Bits 5:0

Baud rate, 0x03 ~ 0x0A

|      |       |       |       |        |
|------|-------|-------|-------|--------|
| Code | 0x03  | 0x04  | 0x05  | 0x06   |
| Baud | 1200  | 2400  | 4800  | 9600   |
| Code | 0x07  | 0x08  | 0x09  | 0x0A   |
| Baud | 19200 | 38400 | 57600 | 115200 |

Bits 7:6

00: no parity, 1 stop bit

01: no parity, 2 stop bits

10: even parity, 1 stop bit

11: odd parity, 1 stop bit

### Data Format Setting (FF)

Bit 6

0: checksum disabled

1: checksum enabled

#### A-4. DL-1023 DCON Command Sets

| Command     | Description   |
|-------------|---|
| \$AAF       | read firmware version   |
| \$AAI       | read INIT status<br>response:<br>!AA0 -> INIT short to GND<br>!AA1 -> else  |
| \$AAM       | read module name  |
| \$AAP       | Read Modbus RTU/DCON protocol<br>response:<br>!AA0 -> DCON<br>!AA1 -> Modbus RTU  |
| \$AAPN      | Set Modbus RTU/DCON protocol<br>N-> 0: DCON, 1: Modbus RTU  |
| \$AA2       | read configuration  |
| \$AA5       | read reset status<br>!AA1 first after power on, !AA0 others   |
| #AA         | Read All Analog Inputs<br>response<br>> (CO in 1 ppm) (CO <sub>2</sub> in 1 ppm) (PM2.5 in 1 ug/m <sup>3</sup> ) (relative humidity in 0.01%)(temperature in 0.01°C)(temperature in 0.01°F) (dew point temperature in 0.01°C)(dew point temperature in 0.01°F) (PM1.0 in 1 ug/m <sup>3</sup> ) (PM10 in 1 ug/m <sup>3</sup> ) (particle count 0.3 - 0.5um) (particle count 0.5 - 1.0um) (particle count 1.0 - 2.5um) (particle count 2.5 - 5.0um) (particle count 5.0 - 7.5um) (particle count 7.5 - 10um)  |
| #AAN        | Read Channel Analog Input<br>N = 0 for CO in 1 ppm, 1 for CO <sub>2</sub> in 1 ppm, 2 for PM2.5 in 1 ug/m <sup>3</sup> , 3 for relative humidity in 0.01%, 4 for temperature in 0.01°C, 5 for temperature in 0.01°F, 6 for dew point temperature in 0.01°C, 7 for dew point temperature in 0.01°F, 8 for PM1.0 in 1 ug/m <sup>3</sup> , 9 for PM10 in 1 ug/m <sup>3</sup> , A for particle count 0.3 - 0.5um, B for particle count 0.5 - 1.0um, C for particle count 1.0 - 2.5um, D for particle count 2.5 - 5.0um, E for particle count 5.0 - 7.5um, F for particle count 7.5 - 10um |
| %AANNTTCCFF | set configuration, NN: new address, TT = 00, CC: new baud rate<br>FF: data format   |
| @AAABC      | Read status of the automatic baseline correction<br>response<br>!AAN, N=0: disabled, 1: enabled   |
| @AAABCN     | Set the automatic baseline correction<br>N->0: disabled, 1: enabled   |
| @AABA       | Read beep on alarm time<br>response<br>!AAHH, HH in hex, 0: disabled, 1 ~ 250: beep on alarm time in seconds, 251: beep on alarm continuously   |
| @AABAHH     | Set beep on alarm<br>HH in hex, 0: disabled, 1 ~ 250: beep on alarm time in seconds, 251: beep on alarm continuously  |

| <b>Command</b> | <b>Description</b>   |
|----------------|--|
| @AABE          | Read enable/disable beep on alarm response<br>!AAHHHH, HHHH in hex, bit 0 for channel 0, bit 1 for channel 1, etc, for each bit, 0: disabled, 1: enabled   |
| @AABEHHHH      | Enable/disable beep on alarm<br>HHHH in hex, , bit 0 for channel 0, bit 1 for channel 1, etc, for each bit, 0: disabled, 1: enabled  |
| @AACH          | Clear all high latched analog inputs to the current values   |
| @AACHN         | Clear channel high latched analog input to the current value, N = 0 for CO1, 1 for CO <sub>2</sub> , 2 for PM2.5, 3 for relative humidity in 0.01%, 4 for temperature in 0.01°C, 5 for temperature in 0.01°F, 6 for dew point temperature in 0.01°C, 7 for dew point temperature in 0.01°F, 8 for PM1.0, 9 for PM10, A for particle count 0.3 - 0.5um, B for particle count 0.5 - 1.0um, C for particle count 1.0 - 2.5um, D for particle count 2.5 - 5.0um, E for particle count 5.0 - 7.5um, F for particle count 7.5 - 10um |
| @AACHCN        | Clear high latched alarm of a channel, N = 0 for CO, 1 for CO <sub>2</sub> , 2 for PM2.5, 3 for relative humidity in 0.01%, 4 for temperature in 0.01°C, 5 for temperature in 0.01°F, 6 for dew point temperature in 0.01°C, 7 for dew point temperature in 0.01°F, 8 for PM1.0, 9 for PM10, A for particle count 0.3 - 0.5um, B for particle count 0.5 - 1.0um, C for particle count 1.0 - 2.5um, D for particle count 2.5 - 5.0um, E for particle count 5.0 - 7.5um, F for particle count 7.5 - 10um                         |
| @AACL          | Clear all low latched analog inputs to the current values  |
| @AACLN         | Clear channel low latched analog input to the current value, N = 0 for CO, 1 for CO <sub>2</sub> , 2 for PM2.5, 3 for relative humidity in 0.01%, 4 for temperature in 0.01°C, 5 for temperature in 0.01°F, 6 for dew point temperature in 0.01°C, 7 for dew point temperature in 0.01°F, 8 for PM1.0, 9 for PM10, A for particle count 0.3 - 0.5um, B for particle count 0.5 - 1.0um, C for particle count 1.0 - 2.5um, D for particle count 2.5 - 5.0um, E for particle count 5.0 - 7.5um, F for particle count 7.5 - 10um   |
| @AACL CN       | Clear low latched alarm of a channel, N = 3 for relative humidity, 4 for temperature in 0.01°C, 5 for temperature in 0.01°F, 6 for dew point temperature in 0.01°C, 7 for dew point temperature in 0.01°F  |
| @AADACN        | Disable AI alarm of a channel, N = 0 for CO, 1 for CO <sub>2</sub> , 2 for PM2.5, 3 for relative humidity in 0.01%, 4 for temperature in 0.01°C, 5 for temperature in 0.01°F, 6 for dew point temperature in 0.01°C, 7 for dew point temperature in 0.01°F, 8 for PM1.0, 9 for PM10, A for particle count 0.3 - 0.5um, B for particle count 0.5 - 1.0um, C for particle count 1.0 - 2.5um, D for particle count 2.5 - 5.0um, E for particle count 5.0 - 7.5um, F for particle count 7.5 - 10um                                 |
| @AADI          | read DO response<br>!AA00000, O: 0 ~ F, DO value in hex format   |
| @AADLB         | Read the beginning of the period setting of the data logger for period logging mode response<br>!AAyyyymmddhhmmss,   |

| <b>Command</b>       | <b>Description</b>   |
|----------------------|--|
| @AADLByyyymmddhhmmss | Set the beginning of the period setting of the data logger for period logging mode<br>yyyy: year, 2000 to 2199, mm: month, 01 to 12, dd: date, 01 to 31, hh: hour, 0 to 24, mm: minute, 0 to 59, ss: second, 0 to 59   |
| @AADLC               | Read the data logger command response<br>!AAh, 0: stop, 1: run, 2: run in period mode  |
| @AADLCh              | Set the data logger command, h->0: stop, 1: run, 2: run in period mode   |
| @AADLE               | Read the ending of the period setting of the data logger for period logging mode response<br>!Ayyyymmddhhmmss  |
| @AADLEyyyymmddhhmmss | Set the ending of the period setting of the data logger for period logging mode<br>yyyy: year, 2000 to 2199, mm: month, 01 to 12, dd: date, 01 to 31, hh: hour, 0 to 24, mm: minute, 0 to 59, ss: second, 0 to 59  |
| @AADLN               | Read number of log records in the data logger response<br>!AAhhhhhhh, hhhhhhhh in hex format   |
| @AADLO               | Read the overwriting mode when data logger is full response<br>!AAh, 0: stop logging when full, 1: overwrite   |
| @AADLOh              | Set the overwriting mode when data logger is full<br>h->0: stop logging when full, 1: overwrite  |
| @AADLP               | Read the samplig period setting of the data logger response<br>!AAhhmmss, hh: hour, 0 to 24, mm: minute, 0 to 59, ss: second, 0 to 59  |
| @AADLPPhmmss         | Set the samplig period setting of the data logger  |
| @AADLS               | Read logging status of the data logger response<br>!AAhh, hh in hex format, 00: stopped, 01: running, others: error  |
| @AAD00V              | set DO, V-> 0 ~ F DO value in hex format, bit 0 for DO0, bit 1 for DO1, etc  |
| @AAEATCN             | Enable AI alarm of a channel, N = 0 for CO, 1 for CO <sub>2</sub> , 2 for PM2.5, 3 for relative humidity in 0.01%, 4 for temperature in 0.01°C, 5 for temperature in 0.01°F, 6 for dew point temperature in 0.01°C, 7 for dew point temperature in 0.01°F, 8 for PM1.0, 9 for PM10, A for particle count 0.3 - 0.5um, B for particle count 0.5 - 1.0um, C for particle count 1.0 - 2.5um, D for particle count 2.5 - 5.0um, E for particle count 5.0 - 7.5um, F for particle count 7.5 - 10um<br>T->M: momentary alarm, L: latched alarm |
| @AAFN                | Read fan status<br>Response<br>!AAE, E=0: fan off, 1: fan on,  |
| @AAFNE               | Turn fan on or off<br>E=0: fan off, 1: fan on  |



| <b>Command</b>        | <b>Description</b>   |
|-----------------------|--|
| @AAFNPi               | Read the ith fan off period in a day, i = 0 to 5<br>response<br>!AAbhbmehem, bh: beginning hour, bm: beginning minute, eh:<br>ending hour, em: ending minute.  |
| @AAFNPibhbmehem       | Set the ith fan off period in a day, i = 0 to 5, bh: beginning hour, 0 to 23,<br>bm: beginning minute, 0 to 59, eh: ending hour, 0 to 23, em: ending<br>minute, 0 to 59. The beginning hour/minute should be earlier than the<br>ending hour/minute. Otherwise, the setting is ignored. If all of the six<br>period settings are invalid, then the fan is controlled by the @AAFNE<br>command.   |
| @AAHI(data)CN         | Set high alarm limit of an AI channel, N = 0 for CO, 1 for CO <sub>2</sub> , 2 for<br>PM2.5, 3 for relative humidity in 0.01%, 4 for temperature in 0.01°C, 5 for<br>temperature in 0.01°F, 6 for dew point temperature in 0.01°C, 7 for dew<br>point temperature in 0.01°F, 8 for PM1.0, 9 for PM10, A for particle count<br>0.3 - 0.5um, B for particle count 0.5 - 1.0um, C for particle count 1.0 -<br>2.5um, D for particle count 2.5 - 5.0um, E for particle count 5.0 - 7.5um, F<br>for particle count 7.5 - 10um |
| @AAHO                 | Read humidity offset   |
| @AAHO(data)           | Set humidity offset, data in format of -100.00 ~ +100.00   |
| @AALO(data)CN         | Set low alarm limit of an AI channel, N = 3 for relative humidity in<br>0.01%, 4 for temperature in 0.01°C, 5 for temperature in 0.01°F, 6 for dew<br>point temperature in 0.01°C, 7 for dew point temperature in 0.01°F   |
| @AAPO                 | Read PM2.5 offset  |
| @AAPO(data)           | Set PM2.5 offset, data in format of -00100. ~ +00100.  |
| @AAP1O                | Read PM1.0 offset  |
| @AAP1O(data)          | Set PM1.0 offset, data in format of -00100. ~ +00100.  |
| @AAP10O               | Read PM10 offset   |
| @AAP10O(data)         | Set PM10 offset, data in format of -00100. ~ +00100.   |
| @AARACN               | Read AI alarm enabled/disabled status of a channel<br>response<br>!AAN, N->0: disabled, 1: momentary, 2: latched   |
| @AARAO                | Read AI alarm status<br>response<br>!AAHHHLLLLL  |
| @AARH                 | Read all high latched values of analog input channels  |
| @AARHN                | Read channel high latched value of analog input  |
| @AARHCN               | Read high alarm limit of an AI channel   |
| @AARL                 | Read all low latched values of analog input channels   |
| @AARLN                | Read channel low latched value of analog input   |
| @AARLCN               | Read low alarm limit of an AI channel  |
| @AART                 | Read RTC data  |
| @AARTYYMMD<br>DHHMMSS | Set RTC data   |
| @AATO                 | Read temperature offset in 0.01°C  |
| @AATO(data)           | Set temperature offset in 0.01°C, -100.00 ~ +100.00  |

| Command  | Description  |
|----------|--|
| ~**      | clear host watchdog timeout counter  |
| ~AA0     | read host watchdog status  |
| ~AA1     | clear host watchdog timeout status   |
| ~AA2     | read host watchdog enable/disable status and timeout value   |
| ~AA3ETT  | enable/disable host watchdog and set timeout value<br>E-> 0: disable host watchdog, 1: enable host watchdog<br>TT: host watchdog timeout in 0.1s in hex format |
| ~AA4     | read DO power on and safe value  |
| ~AA50P0S | set DO power on and safe value<br>P-> 0 ~ F: power on value in hex format<br>S-> 0 ~ F: safe value in hex format   |
| ~AARD    | read response delay time in ms in hex format   |
| ~AARDVV  | set response delay time in ms, VV in hex format, 00 - 1E   |

### Baud Rate Setting (CC)

Bits 5:0

Baud rate, 0x03 ~ 0x0A

|      |       |       |       |        |
|------|-------|-------|-------|--------|
| Code | 0x03  | 0x04  | 0x05  | 0x06   |
| Baud | 1200  | 2400  | 4800  | 9600   |
| Code | 0x07  | 0x08  | 0x09  | 0x0A   |
| Baud | 19200 | 38400 | 57600 | 115200 |

Bits 7:6

00: no parity, 1 stop bit

01: no parity, 2 stop bits

10: even parity, 1 stop bit

11: odd parity, 1 stop bit

### Data Format Setting (FF)

Bit 6

0: checksum disabled

1: checksum enabled

## A-5. DL-1038 DCON Command Sets

| Command    | Description  |
|------------|--|
| \$AAF      | read firmware version  |
| \$AAI      | read INIT status<br>response:<br>!AA0 -> INIT short to GND<br>!AA1 -> else   |
| \$AAM      | read module name   |
| \$AAP      | Read Modbus RTU/DCON protocol<br>response:<br>!AA0 -> DCON<br>!AA1 -> Modbus RTU   |
| \$AAPN     | Set Modbus RTU/DCON protocol<br>N-> 0: DCON, 1: Modbus RTU   |
| \$AA2      | read configuration   |
| \$AA5      | read reset status<br>!AA1 first after power on, !AA0 others  |
| #AA        | Read All Analog Inputs<br>response<br>> (CO in 1 ppm) (CO <sub>2</sub> in 1 ppm) (TVOC in 1 ppb) (PM2.5 in 1 ug/m <sup>3</sup> ) (relative humidity in 0.01%)(temperature in 0.01° C)(temperature in 0.01°F) (dew point temperature in 0.01°C)(dew point temperature in 0.01°F) (PM1.0 in 1 ug/m <sup>3</sup> ) (PM10 in 1 ug/m <sup>3</sup> ) (particle count 0.3 - 0.5um) (particle count 0.5 - 1.0um) (particle count 1.0 - 2.5um) (particle count 2.5 - 5.0um) (particle count 5.0 - 7.5um) (particle count 7.5 - 10um)  |
| #AANN      | Read Channel Analog Input<br>N = 00 for CO in 1 ppm, 01 for CO <sub>2</sub> in 1 ppm, 02 for TVOC in 1 ppb, 03for PM2.5 in 1 ug/m <sup>3</sup> , 04 for relative humidity in 0.01%, 05 for temperature in 0.01°C, 06 for temperature in 0.01°F, 07 for dew point temperature in 0.01°C, 08 for dew point temperature in 0.01°F, 09 for PM1.0 in 1 ug/m <sup>3</sup> , 0A for PM10 in 1 ug/m <sup>3</sup> , 0B for particle count 0.3 - 0.5um, 0C for particle count 0.5 - 1.0um, 0D for particle count 1.0 - 2.5um, 0E for particle count 2.5 - 5.0um, 0F for particle count 5.0 - 7.5um, 10 for particle count 7.5 - 10um |
| %AANNTTCFF | set configuration, NN: new address, TT = 00, CC: new baud rate<br>FF: data format  |
| @AAABC     | Read status of the automatic baseline correction<br>response<br>!AAN, N=0: disabled, 1: enabled  |
| @AAABCN    | Set the automatic baseline correction<br>N->0: disabled, 1: enabled  |
| @AABA      | Read beep on alarm time<br>response<br>!AAHH, HH in hex, 0: disabled, 1 ~ 250: beep on alarm time in seconds, 251: beep on alarm continuously  |

| <b>Command</b> | <b>Description</b>  |
|----------------|---|
| @AABAHH        | Set beep on alarm<br>HH in hex, 0: disabled, 1 ~ 250: beep on alarm time in seconds, 251: beep on alarm continuously  |
| @AABE          | Read enable/disable beep on alarm response<br>!AAHHHHHH, HHHHHH in hex, bit 0 for channel 0, bit 1 for channel 1, etc, for each bit, 0: disabled, 1: enabled  |
| @AABEH<br>HH   | Enable/disable beep on alarm<br>HHHHHH in hex, , bit 0 for channel 0, bit 1 for channel 1, etc, for each bit, 0: disabled, 1: enabled   |
| @AACH          | Clear all high latched analog inputs to the current values  |
| @AACHNN        | Clear channel high latched analog input to the current value, N = 00 for CO1, 01 for CO <sub>2</sub> , 02 for TVOC, 03 for PM2.5, 04 for relative humidity in 0.01%, 05 for temperature in 0.01°C, 06 for temperature in 0.01°F, 07 for dew point temperature in 0.01°C, 08 for dew point temperature in 0.01°F, 09 for PM1.0, 0A for PM10, 0B for particle count 0.3 - 0.5um, 0C for particle count 0.5 - 1.0um, 0D for particle count 1.0 - 2.5um, 0E for particle count 2.5 - 5.0um, 0F for particle count 5.0 - 7.5um, 10 for particle count 7.5 - 10um |
| @AACHC<br>NN   | Clear high latched alarm of a channel, N = 00 for CO, 01 for CO <sub>2</sub> , 02 for TVOC, 03 for PM2.5, 04 for relative humidity in 0.01%, 05 for temperature in 0.01°C, 06 for temperature in 0.01°F, 07 for dew point temperature in 0.01°C, 08 for dew point temperature in 0.01°F, 09 for PM1.0, 0A for PM10, 0B for particle count 0.3 - 0.5um, 0C for particle count 0.5 - 1.0um, 0D for particle count 1.0 - 2.5um, 0E for particle count 2.5 - 5.0um, 0F for particle count 5.0 - 7.5um, 10 for particle count 7.5 - 10um                         |
| @AAAL          | Clear all low latched analog inputs to the current values   |
| @AAALNN        | Clear channel low latched analog input to the current value, N = 00 for CO, 01 for CO <sub>2</sub> , 02 for TVOC, 03 for PM2.5, 04 for relative humidity in 0.01%, 05 for temperature in 0.01°C, 06 for temperature in 0.01°F, 07 for dew point temperature in 0.01°C, 08 for dew point temperature in 0.01°F, 09 for PM1.0, 0A for PM10, 0B for particle count 0.3 - 0.5um, 0C for particle count 0.5 - 1.0um, 0D for particle count 1.0 - 2.5um, 0E for particle count 2.5 - 5.0um, 0F for particle count 5.0 - 7.5um, 10 for particle count 7.5 - 10um   |
| @AAALC<br>NN   | Clear low latched alarm of a channel, N = 04 for relative humidity, 05 for temperature in 0.01°C, 06 for temperature in 0.01°F, 07 for dew point temperature in 0.01°C, 08 for dew point temperature in 0.01°F  |
| @AADAC<br>NN   | Disable AI alarm of a channel, N = 00 for CO, 01 for CO <sub>2</sub> , 02 for TVOC, 03 for PM2.5, 04 for relative humidity in 0.01%, 05 for temperature in 0.01°C, 06 for temperature in 0.01°F, 07 for dew point temperature in 0.01°C, 08 for dew point temperature in 0.01°F, 09 for PM1.0, 0A for PM10, 0B for particle count 0.3 - 0.5um, 0C for particle count 0.5 - 1.0um, 0D for particle count 1.0 - 2.5um, 0E for particle count 2.5 - 5.0um, 0F for particle count 5.0 - 7.5um, 10 for particle count 7.5 - 10um                                 |

| <b>Command</b>        | <b>Description</b>   |
|-----------------------|--|
| @AADI                 | read DO<br>response<br>!AA0000, O: 0 ~ F, DO value in hex format   |
| @AADLB                | Read the beginning of the period setting of the data logger for period logging mode<br>response<br>!AAyyyymmddhhmmss,  |
| @AADLByyyyymmddhhmmss | Set the beginning of the period setting of the data logger for period logging mode<br>yyyy: year, 2000 to 2199, mm: month, 01 to 12, dd: date, 01 to 31, hh: hour, 0 to 24, mm: minute, 0 to 59, ss: second, 0 to 59 |
| @AADLC                | Read the data logger command<br>response<br>!AAh, 0: stop, 1: run, 2: run in period mode   |
| @AADLCh               | Set the data logger command, h->0: stop, 1: run, 2: run in period mode   |
| @AADLE                | Read the ending of the period setting of the data logger for period logging mode<br>response<br>!AAyyyymmddhhmmss  |
| @AADLEyyyymmddhhmmss  | Set the ending of the period setting of the data logger for period logging mode<br>yyyy: year, 2000 to 2199, mm: month, 01 to 12, dd: date, 01 to 31, hh: hour, 0 to 24, mm: minute, 0 to 59, ss: second, 0 to 59    |
| @AADLN                | Read number of log records in the data logger<br>response<br>!AAhhhhhhhh, hhhhhhhh in hex format   |
| @AADLO                | Read the overwriting mode when data logger is full<br>response<br>!AAh, 0: stop logging when full, 1: overwrite  |
| @AADLOh               | Set the overwriting mode when data logger is full<br>h->0: stop logging when full, 1: overwrite  |
| @AADLP                | Read the samplig period setting of the data logger<br>response<br>!AAhhmmss, hh: hour, 0 to 24, mm: minute, 0 to 59, ss: second, 0 to 59   |
| @AADLPPhmmss          | Set the samplig period setting of the data logger  |
| @AADLS                | Read logging status of the data logger<br>response<br>!AAhh, hh in hex format, 00: stopped, 01: running, others: error   |
| @AADO0V               | set DO, V-> 0 ~ F DO value in hex format, bit 0 for DO0, bit 1 for DO1, etc  |

| <b>Command</b>  | <b>Description</b>   |
|-----------------|--|
| @AAEATCNN       | Enable AI alarm of a channel, N = 00 for CO, 01 for CO <sub>2</sub> , 02 for TVOC, 03 for PM <sub>2.5</sub> , 04 for relative humidity in 0.01%, 05 for temperature in 0.01 °C, 06 for temperature in 0.01 °F, 07 for dew point temperature in 0.01 °C, 08 for dew point temperature in 0.01 °F, 09 for PM <sub>1.0</sub> , 0A for PM <sub>10</sub> , 0B for particle count 0.3 - 0.5um, 0C for particle count 0.5 - 1.0um, 0D for particle count 1.0 - 2.5um, 0E for particle count 2.5 - 5.0um, 0F for particle count 5.0 - 7.5um, 10 for particle count 7.5 - 10um<br>T->M: momentary alarm, L: latched alarm |
| @AAFN           | Read fan status<br>Response<br>!AAE, E=0: fan off, 1: fan on,  |
| @AAFNE          | Turn fan on or off<br>E=0: fan off, 1: fan on  |
| @AAFNPi         | Read the ith fan off period in a day, i = 0 to 5<br>response<br>!AAbhbmehem, bh: beginning hour, bm: beginning minute, eh: ending hour, em: ending minute.   |
| @AAFNPibhbmehem | Set the ith fan off period in a day, i = 0 to 5, bh: beginning hour, 0 to 23, bm: beginning minute, 0 to 59, eh: ending hour, 0 to 23, em: ending minute, 0 to 59. The beginning hour/minute should be earlier than the ending hour/minute. Otherwise, the setting is ignored. If all of the six period settings are invalid, then the fan is controlled by the @AAFNE command.  |
| @AAHI(data)CNN  | Set high alarm limit of an AI channel, N = 00 for CO, 01 for CO <sub>2</sub> , 02 for TVOC, 03 for PM <sub>2.5</sub> , 04 for relative humidity in 0.01%, 05 for temperature in 0.01 °C, 06 for temperature in 0.01 °F, 07 for dew point temperature in 0.01 °C, 08 for dew point temperature in 0.01 °F, 09 for PM <sub>1.0</sub> , 0A for PM <sub>10</sub> , 0B for particle count 0.3 - 0.5um, 0C for particle count 0.5 - 1.0um, 0D for particle count 1.0 - 2.5um, 0E for particle count 2.5 - 5.0um, 0F for particle count 5.0 - 7.5um, 10 for particle count 7.5 - 10um                                   |
| @AAHO           | Read humidity offset   |
| @AAHO(data)     | Set humidity offset, data in format of -100.00 ~ +100.00   |
| @AALO(data)CNN  | Set low alarm limit of an AI channel, N = 04 for relative humidity in 0.01%, 05 for temperature in 0.01 °C, 06 for temperature in 0.01 °F, 07 for dew point temperature in 0.01 °C, 08 for dew point temperature in 0.01 °F  |
| @AAPO           | Read PM <sub>2.5</sub> offset  |
| @AAPO(data)     | Set PM <sub>2.5</sub> offset, data in format of -00100. ~ +00100.  |
| @AAP1O          | Read PM <sub>1.0</sub> offset  |
| @AAP1O(data)    | Set PM <sub>1.0</sub> offset, data in format of -00100. ~ +00100.  |
| @AAP10O         | Read PM <sub>10</sub> offset   |
| @AAP10O(data)   | Set PM <sub>10</sub> offset, data in format of -00100. ~ +00100.   |
| @AARACNN        | Read AI alarm enabled/disabled status of a channel<br>response<br>!AAN, N->0: disabled, 1: momentary, 2: latched   |
| @AARAO          | Read AI alarm status<br>response<br>!AAHHHHHLLLLL  |

| <b>Command</b>        | <b>Description</b>   |
|-----------------------|--|
| @AARH                 | Read all high latched values of analog input channels  |
| @AARHNN               | Read channel high latched value of analog input  |
| @AARHCNN              | Read high alarm limit of an AI channel   |
| @AARL                 | Read all low latched values of analog input channels   |
| @AARLNN               | Read channel low latched value of analog input   |
| @AARLCNN              | Read low alarm limit of an AI channel  |
| @AART                 | Read RTC data  |
| @AARTYYMMD<br>DHHMMSS | Set RTC data   |
| @AATO                 | Read temperature offset in 0.01°C  |
| @AATO(data)           | Set temperature offset in 0.01°C, -100.00 ~ +100.00  |
| @AAVO                 | Read TVOC offset   |
| @AAVO(data)           | Set TVOC offset, data in format of -00100. ~ +00100.   |
| ~**                   | clear host watchdog timeout counter  |
| ~AA0                  | read host watchdog status  |
| ~AA1                  | clear host watchdog timeout status   |
| ~AA2                  | read host watchdog enable/disable status and timeout value   |
| ~AA3ETT               | enable/disable host watchdog and set timeout value<br>E-> 0: disable host watchdog, 1: enable host watchdog<br>TT: host watchdog timeout in 0.1s in hex format |
| ~AA4                  | read DO power on and safe value  |
| ~AA50POS              | set DO power on and safe value<br>P-> 0 ~ F: power on value in hex format<br>S-> 0 ~ F: safe value in hex format   |
| ~AARD                 | read response delay time in ms in hex format   |
| ~AARDVV               | set response delay time in ms, VV in hex format, 00 - 1E   |

## Baud Rate Setting (CC)

Bits 5:0

Baud rate, 0x03 ~ 0x0A

|      |       |       |       |        |
|------|-------|-------|-------|--------|
| Code | 0x03  | 0x04  | 0x05  | 0x06   |
| Baud | 1200  | 2400  | 4800  | 9600   |
| Code | 0x07  | 0x08  | 0x09  | 0x0A   |
| Baud | 19200 | 38400 | 57600 | 115200 |

Bits 7:6

00: no parity, 1 stop bit

01: no parity, 2 stop bits

10: even parity, 1 stop bit

11: odd parity, 1 stop bit

## Data Format Setting (FF)

Bit 6

0: checksum disabled

1: checksum enabled

---

## Appendix B: ModbusMasterToolPC

ModbusMasterToolPC is a free, easy-to-use tool for Modbus communication and diagnosing the wiring.

Download and install the ModbusMasterToolPC

<http://ftp.icpdas.com/pub/cd/usbcd/napdos/iiot/utility/modbusmastertoolpc/>

This section intends to guide the steps for creating the Modbus communication with DL-1000 logger.

1. Launch the ModbusMasterToolPC.exe.
2. Select **New** in the File menu.

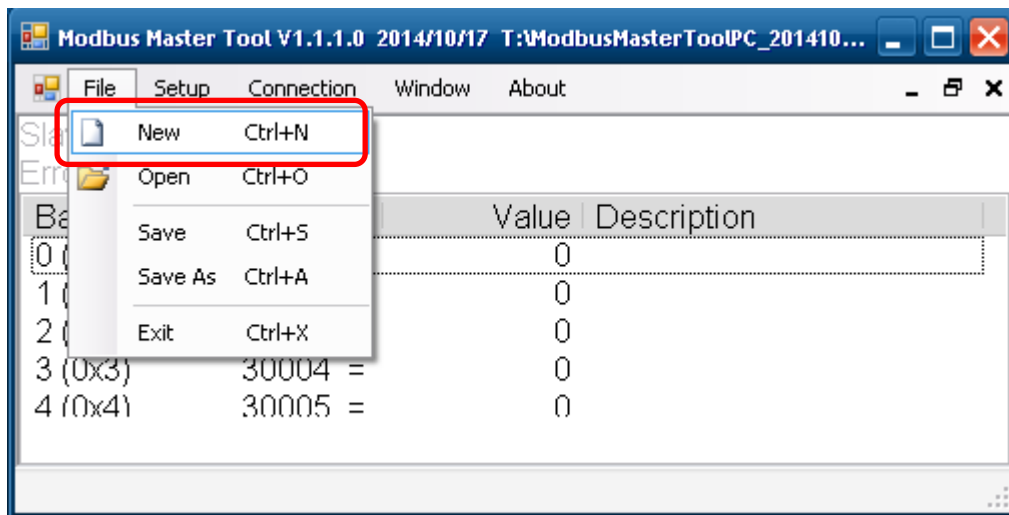

3. Input the file name and click on the **Save** button.

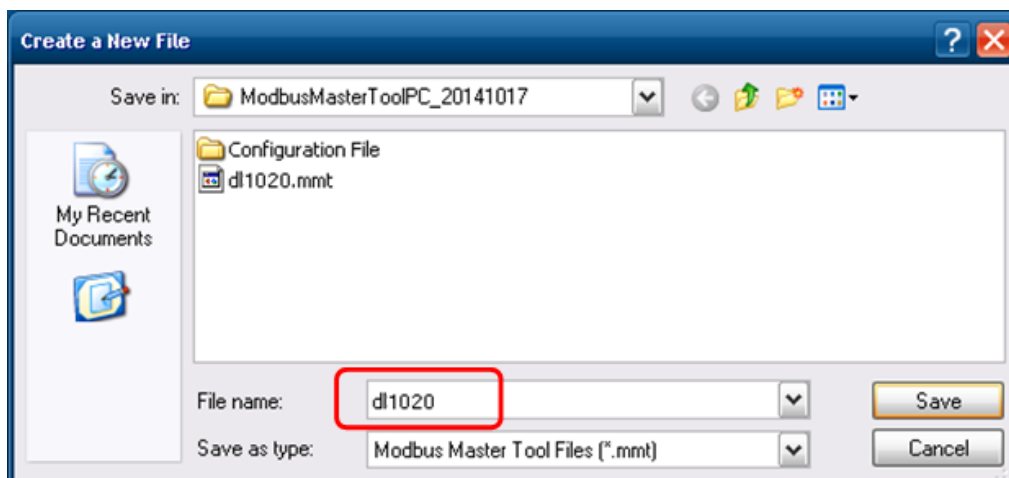



4. Select **Connect** in the *Connection* menu.

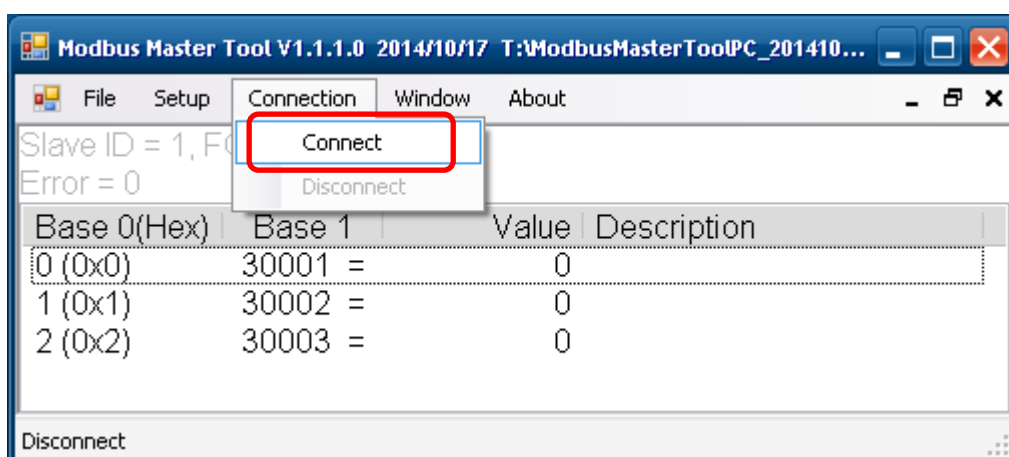

5. Select the communication interface. When using **TCP/IP** as the interface, input the IP for your logger and click on the **OK** button.

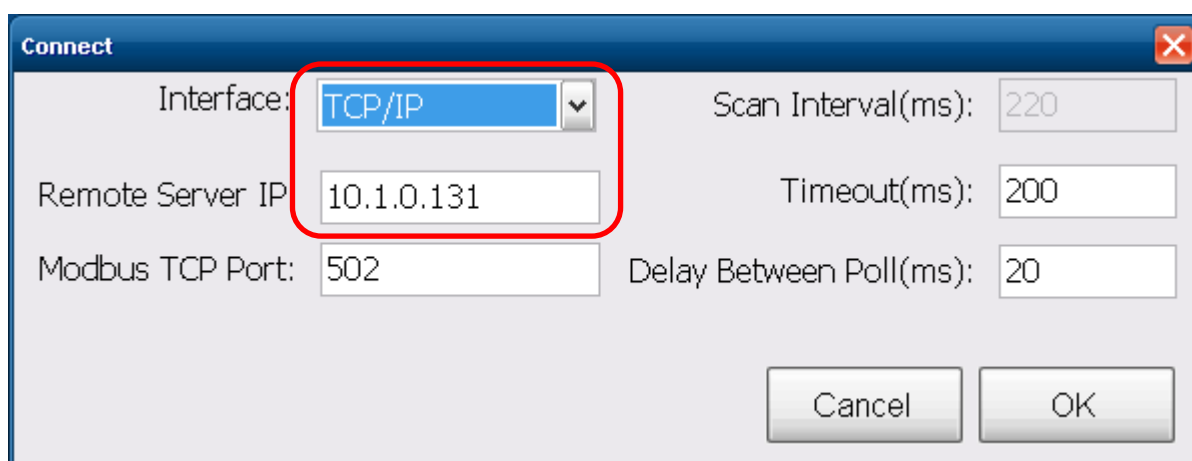

When using RS-485 as the interface, select the COM port, check the RTU mode and click on the **OK** button.

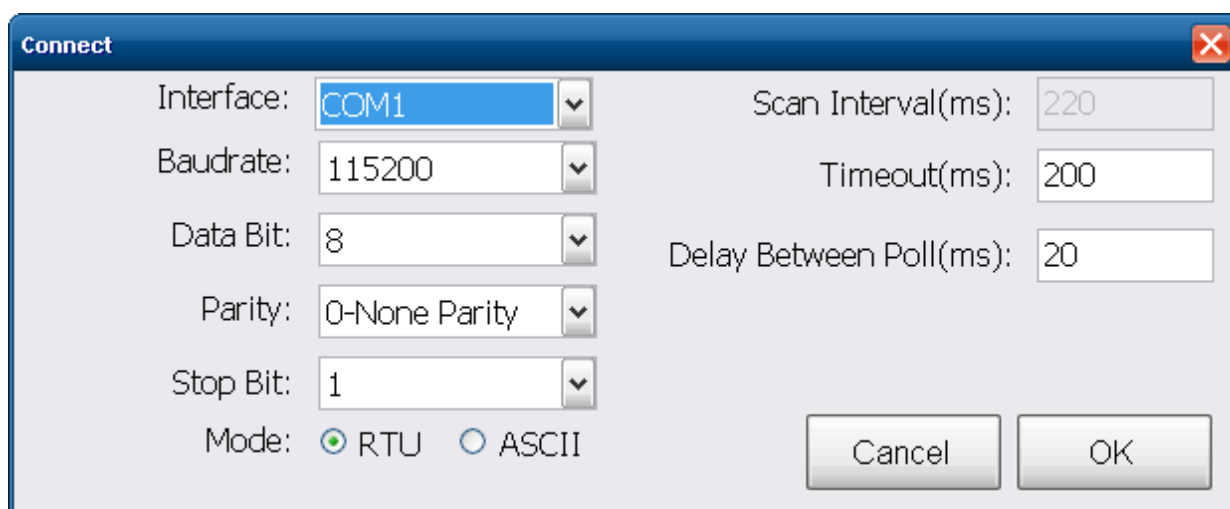

6. Select **Definition** in the *Setup* menu.

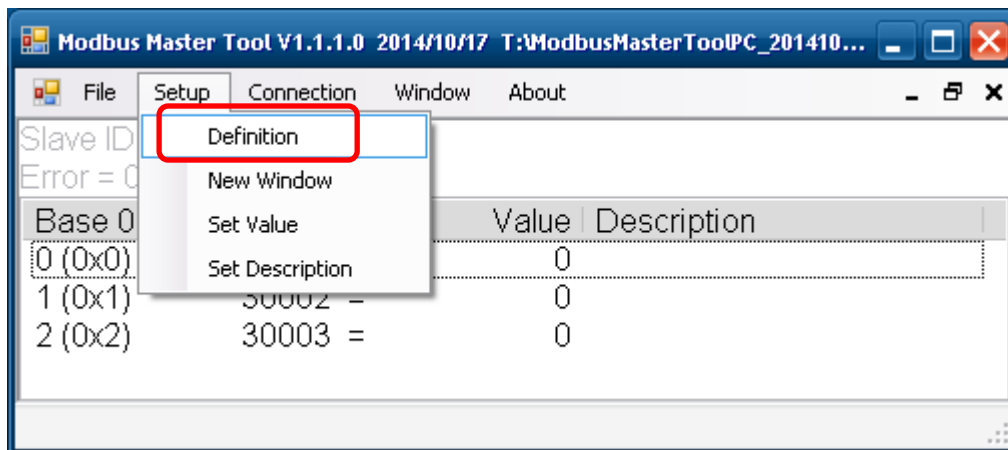

7. Select the Modbus function code, input the start address and length, and click on the **OK** button.

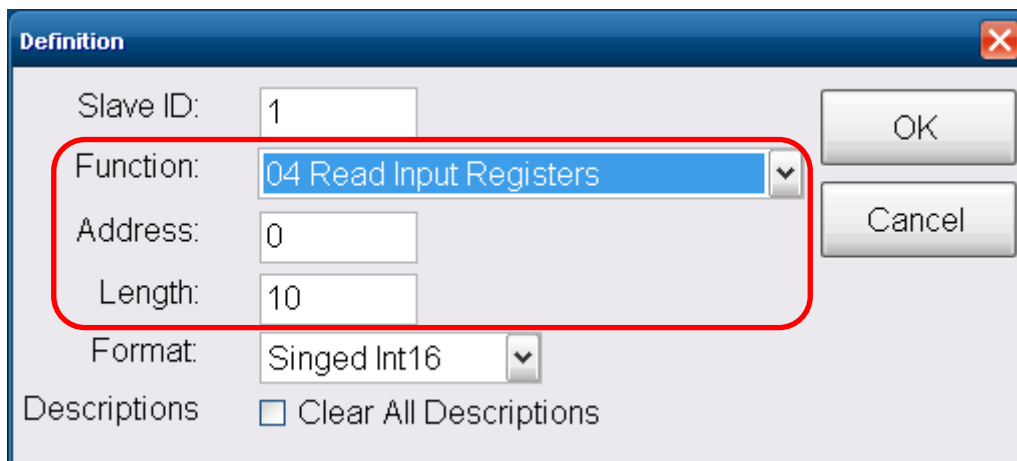

8. Read data.

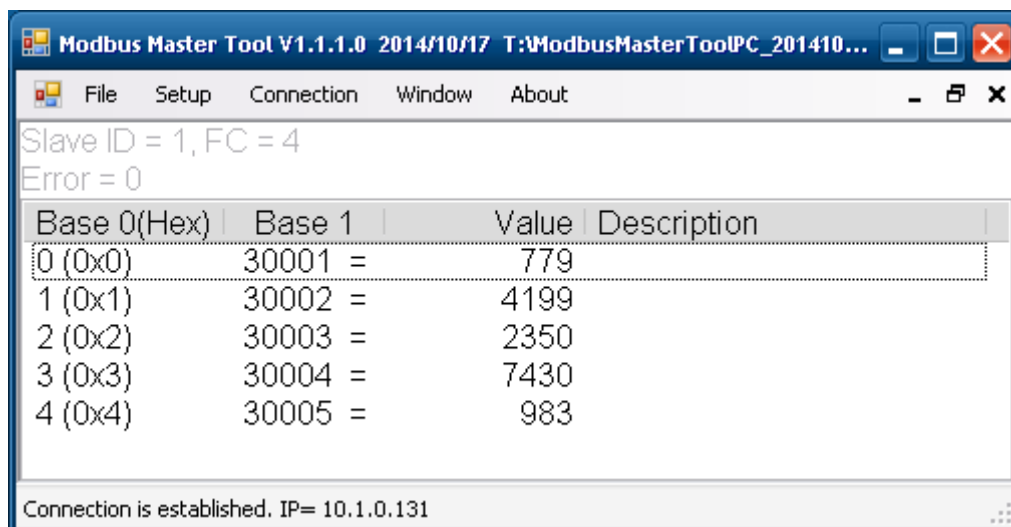

## 9. Write data to Holding Register or Coil Status

1. Highlight the Modbus address in the Holding Register or Coil Status list
2. Select **Set Value** in the *Setup* menu.
3. Input the data in the Value box and click on the **OK** button

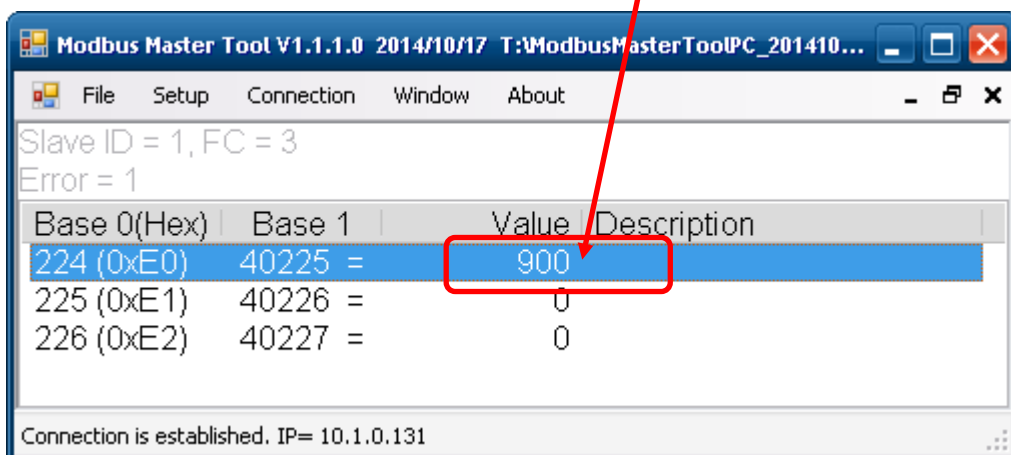
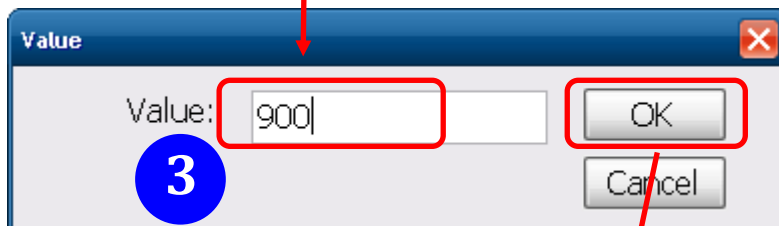
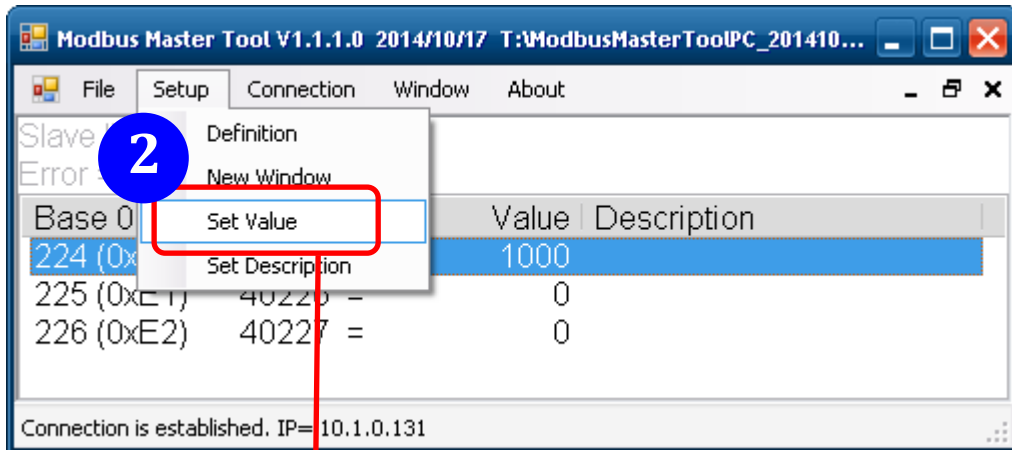

## Appendix C: Modbus Address Table

### C-1. DL-1020 Modbus Address Mappings (Base 1)

| Address                              | Description  | Attribute |
|--------------------------------------|--|-----------|
| 30001 ~<br>30014<br>40001 ~<br>40014 | Analog input value of channel 0 to 13. channel 0: PM2.5 in $1\mu\text{g}/\text{m}^3$ , channel 1: relative humidity in 0.01%, channel 2: temperature in $0.01^\circ\text{C}$ , channel 3: temperature in $0.01^\circ\text{F}$ , channel 4: dew point temperature in $0.01^\circ\text{C}$ , channel 5: dew point temperature in $0.01^\circ\text{F}$ , channel 6: PM1.0 in $1\mu\text{g}/\text{m}^3$ , channel 7: PM10 in $1\mu\text{g}/\text{m}^3$ , channel 8: particle count (0.3 - 0.5 $\mu\text{m}$ ), channel 9: particle count (0.5 - 1.0 $\mu\text{m}$ ), channel 10: particle count (1.0 - 2.5 $\mu\text{m}$ ), channel 11: particle count (2.5 - 5.0 $\mu\text{m}$ ), channel 12: particle count (5.0 - 7.5 $\mu\text{m}$ ), channel 13: particle count (7.5 - 10.0 $\mu\text{m}$ ) | R         |
| 40225 ~<br>40238                     | High alarm limit of channel 0 to 13, channel 0: PM2.5 in $1\mu\text{g}/\text{m}^3$ , channel 1: relative humidity in 0.01%, channel 2: temperature in $0.01^\circ\text{C}$ , channel 3: temperature in $0.01^\circ\text{F}$ , channel 4: dew point temperature in $0.01^\circ\text{C}$ , channel 5: dew point temperature in $0.01^\circ\text{F}$ , channel 6: PM1.0 in $1\mu\text{g}/\text{m}^3$ , channel 7: PM10 in $1\mu\text{g}/\text{m}^3$ , channel 8: particle count (0.3 - 0.5 $\mu\text{m}$ ), channel 9: particle count (0.5 - 1.0 (2.5 - 5.0 $\mu\text{m}$ ), channel 12: particle count (5.0 - 7.5 $\mu\text{m}$ ), channel 13: particle count (7.5 - 10.0 $\mu\text{m}$ )0 $\mu\text{m}$ ), channel 10: particle count (1.0 - 2.5 $\mu\text{m}$ ), channel 11: particle count  | R/W       |
| 40242 ~<br>40246                     | Low alarm limit of channel 1 to 5, channel 1: relative humidity in 0.01%, channel 2: temperature in $0.01^\circ\text{C}$ , channel 3: temperature in $0.01^\circ\text{F}$ , channel 4: dew point temperature in $0.01^\circ\text{C}$ , channel 5: dew point temperature in $0.01^\circ\text{F}$  | R/W       |

| <b>Address</b> | <b>Description</b>   | <b>Attribute</b> |
|----------------|--|------------------|
| 40272          | Modbus NetID<br>Only for Modbus TCP protocol   | R/W              |
| 30301<br>40301 | Number of the digital input channels<br>Only for Modbus TCP protocol   | R                |
| 30311<br>40311 | Number of the digital output channels<br>Only for Modbus TCP protocol  | R                |
| 30321<br>40321 | Number of the analog input channels<br>Only for Modbus TCP protocol  | R                |
| 30331<br>40331 | Number of the analog output channels<br>Only for Modbus TCP protocol   | R                |
| 30352<br>40352 | Firmware version in hex format<br>Only for Modbus TCP protocol   | R                |
| 40449          | PM2.5 offset in 1 ug/m <sup>3</sup>  | R/W              |
| 40450          | Relative humidity offset in 0.01%  | R/W              |
| 40451          | Temperature offset in 0.01°C   | R/W              |
| 40455          | PM1.0 offset in 1 ug/m <sup>3</sup>  | R/W              |
| 40456          | PM10 offset in 1 ug/m <sup>3</sup>   | R/W              |
| 40481          | Firmware version (low word)  | R                |
| 40482          | Firmware version (high word)   | R                |
| 40483          | Module name (low word), 0x1020   | R                |
| 40484          | Module name (high word), 0x444C  | R                |
| 40485          | RS-485 module address, 1 to 247<br>Only for Modbus RTU protocol  | R/W              |
| 40486          | RS-485 baud rate and parity settings<br>Bits 5:0<br>Baud rate, valid range: 3 ~ 10<br>Bits 7:6<br>00: no parity, 1 stop bit<br>01: no parity, 2 stop bit<br>10: even parity, 1 stop bit<br>11: odd parity , 1 stop bit<br>Only for Modbus RTU protocol | R/W              |
| 40488          | RS-485 response delay time in ms, valid range, 0 ~ 30<br>Only for Modbus RTU protocol  | R/W              |

| <b>Address</b>                 | <b>Description</b>   | <b>Attribute</b> |
|--------------------------------|--|------------------|
| 40489                          | RS-485 host watchdog timeout value, 0 ~ 255, in 0.1s<br>Only for Modbus RTU protocol                       | R/W              |
| 40492                          | RS-485 host watchdog timeout count, write 0 to clear<br>Only for Modbus RTU protocol                       | R/W              |
| 40497                          | Beep on alarm, 0: disable, 1 to 250: beep on alarm time in seconds, 251: beep on alarm continuously        | R/W              |
| 30513 ~ 30526<br>40513 ~ 40526 | High latched analog input value of channel 0 to 13   | R                |
| 30545 ~ 30558<br>40545 ~ 40558 | Low latched analog input value of channel 0 to 13  | R                |
| 30566<br>40566                 | Module reset status, 1: power-on, 2: watchdog, 3: software reset command<br>Only for Modbus TCP protocol   | R                |
| 40568                          | Ethernet host watchdog timeout value, 5 to 65535, in second, 0 to disable.<br>Only for Modbus TCP protocol | R/W              |
| 30569<br>40569                 | Ethernet host watchdog timeout count.<br>Only for Modbus TCP protocol                                      | R                |
| 30570<br>40570                 | Module name, 0x1020<br>Only for Modbus TCP protocol  | R                |
| 40564                          | TCP disconnection timeout value, 5 to 65535, in second, 0 to disable.<br>Only for Modbus TCP protocol      | R/W              |
| 40565                          | Module reset timeout value, 30 to 65535, in second, 0 to disable.<br>Only for Modbus TCP protocol          | R/W              |

| <b>Address</b> | <b>Description</b>  | <b>Attribute</b> |
|----------------|---|------------------|
| 40865          | RTC year, 2000 to 2159  | R/W              |
| 40866          | RTC month, 1 to 12  | R/W              |
| 40867          | RTC date, 1 to 31   | R/W              |
| 40868          | RTC hour, 0 to 23   | R/W              |
| 40869          | RTC minute, 0 to 59   | R/W              |
| 40870          | RTC second, 0 to 59   | R/W              |
| 40871          | Total number of log records, low word                           | R                |
| 40872          | Total number of log records, high word                          | R                |
| 40873          | The starting record to read log data, low word                  | R/W              |
| 40874          | The starting record to read log data, high word                 | R/W              |
| 40875          | The status of the data logging, 0: stopped, 1: running          | R                |
| 40876          | The data logger command, 0: stop, 1: run, 2: run in period mode | R/W              |
| 40877          | Continue writing when data logger is full, 0: no, 1: yes        | R/W              |
| 40878          | Hour of the data logger sampling period, 0 ~ 24                 | R/W              |
| 40879          | Minute of the data logger sampling period, 0 ~ 59               | R/W              |
| 40880          | Second of the data logger sampling period, 0 ~ 59               | R/W              |
| 40881          | Starting year when logging in period mode, 2000 ~ 2159          | R/W              |
| 40882          | Starting month when logging in period mode, 1 ~ 12              | R/W              |
| 40883          | Starting date when logging in period mode, 1 ~ 31               | R/W              |
| 40884          | Starting hour when logging in period mode, 0 ~ 23               | R/W              |
| 40885          | Starting minute when logging in period mode, 0 ~ 59             | R/W              |
| 40886          | Starting second when logging in period mode, 0 ~ 59             | R/W              |
| 40887          | Ending year when logging in period mode, 2000 ~ 2159            | R/W              |
| 40888          | Ending month when logging in period mode, 1 ~ 12                | R/W              |
| 40889          | Ending date when logging in period mode, 1 ~ 31                 | R/W              |
| 40890          | Ending hour when logging in period mode, 0 ~ 23                 | R/W              |

| <b>Address</b> | <b>Description</b>  | <b>Attribute</b> |
|----------------|---|------------------|
| 40891          | Ending minute when logging in period mode, 0 ~ 59                       | R/W              |
| 40892          | Ending second when logging in period mode, 0 ~ 59                       | R/W              |
| 40929          | The first fan off period in a day, beginning hour, 0 ~ 23               | R/W              |
| 40930          | The first fan off period in a day, beginning minute, 0 ~ 59             | R/W              |
| 40931          | The first fan off period in a day, ending hour, 0 ~ 23                  | R/W              |
| 40932          | The first fan off period in a day, ending minute, 0 ~ 59                | R/W              |
| 40933 ~ 40936  | The second fan off period in a day                                      | R/W              |
| 40937 ~ 40940  | The third fan off period in a day                                       | R/W              |
| 40941 ~ 40944  | The fourth fan off period in a day                                      | R/W              |
| 40945 ~ 40948  | The fifth fan off period in a day                                       | R/W              |
| 40949 ~ 40952  | The sixth fan off period in a day                                       | R/W              |
| 00001 ~ 00004  | Digital output value of channel 0 to 3                                  | R/W              |
| 00129 ~ 00132  | Safe value of digital output channel 0 to 3                             | R/W              |
| 00161 ~ 00164  | Power on value of digital output channel 0 to 3                         | R/W              |
| 00227          | Write 1 to reload default TCP settings<br>Only for Modbus TCP protocol  | W                |
| 00234          | Write 1 to reboot module<br>Only for Modbus TCP protocol                | W                |
| 00257          | RS-485 Protocol, 0: DCON, 1: Modbus RTU<br>Only for Modbus RTU protocol | R/W              |



| <b>Address</b>   | <b>Description</b>   | <b>Attribute</b> |
|------------------|--|------------------|
| 00260            | Modbus RTU host watchdog mode<br>0: same as I-7000<br>1: can use AO and DO command to clear host watchdog timeout status<br>Only for Modbus RTU protocol | R/W              |
| 00261            | RS-485 host watchdog mode, 1: enable, 0: disable.<br>Only for Modbus RTU protocol  | R/W              |
| 00262            | Write 1 to play notification sound   | W                |
| 00270            | Host watch dog timeout status, write 1 to clear host watch dog timeout status<br>Only for Modbus RTU protocol  | R/W              |
| 00273            | Reset status, 1: first read after powered on, 0: not the first read after powered on<br>Only for Modbus RTU protocol                                     | R                |
| 00279            | Fan control, 0: off, 1: on   | R/W              |
| 00280            | Write 1 to clear all high latched analog input values  | W                |
| 00281            | Write 1 to clear all low latched analog input values   | W                |
| 00290 ~<br>00294 | Low alarm status of channel 1 to 5. Write 1 to clear low latched alarm.  | R/W              |
| 00305 ~<br>00318 | High alarm status of channel 0 to 13. Write 1 to clear high latched alarm.   | R/W              |
| 00321 ~<br>00334 | Enable/disable alarm of channel 0 to 13  | R/W              |
| 00337 ~<br>00350 | Alarm type, momentary or latched, of channel 0 to 13   | R/W              |
| 00385 ~<br>00398 | Write 1 to clear high latched analog input value of channel 0 to 13  | W                |
| 00417 ~<br>00430 | Write 1 to clear low latched analog input value of channel 0 to 13   | W                |
| 00449 ~<br>00462 | Enable/disable beep on alarm for channel 0 to 13   | R/W              |

## C-2. DL-1021 Modbus Address Mappings (Base 1)

| Address                              | Description  | Attribute |
|--------------------------------------|--|-----------|
| 30001 ~<br>30015<br>40001 ~<br>40015 | Analog input value of channel 0 to 14. channel 0: CO in 1ppm, channel 1: PM2.5 in 1ug/m <sup>3</sup> , channel 2: relative humidity in 0.01%, channel 3: temperature in 0.01°C, channel 4:temperature in 0.01°F, channel 5: dew point temperature in 0.01°C, channel 6: dew point temperature in 0.01°F, channel 7: PM1.0 in 1ug/m <sup>3</sup> , channel 8: PM10 in 1ug/m <sup>3</sup> , channel 9: particle count (0.3 - 0.5um), channel 10: particle count (0.5 - 1.0um), channel 11: particle count (1.0 - 2.5um), channel 12: particle count (2.5 - 5.0um), channel 13: particle count (5.0 - 7.5um), channel 14: particle count (7.5 - 10.0um) | R         |
| 40225 ~<br>40239                     | High alarm limit of channel 0 to 14, channel 0: CO in 1ppm, channel 1: PM2.5 in 1ug/m <sup>3</sup> , channel 2: relative humidity in 0.01%, channel 3: temperature in 0.01°C, channel 4:temperature in 0.01°F, channel 5: dew point temperature in 0.01°C, channel 6: dew point temperature in 0.01°F, channel 7: PM1.0 in 1ug/m <sup>3</sup> , channel 8: PM10 in 1ug/m <sup>3</sup> , channel 9: particle count (0.3 - 0.5um), channel 10: particle count (0.5 - 1.0um), channel 11: particle count (1.0 - 2.5um), channel 12: particle count (2.5 - 5.0um), channel 13: particle count (5.0 - 7.5um), channel 14: particle count (7.5 - 10.0um)   | R/W       |
| 40243 ~<br>40247                     | Low alarm limit of channel 2 to 6, channel 2: relative humidity in 0.01%, channel 3: temperature in 0.01°C, channel 4:temperature in 0.01°F, channel 5: dew point temperature in 0.01°C, channel 6: dew point temperature in 0.01°F  | R/W       |

| <b>Address</b> | <b>Description</b>   | <b>Attribute</b> |
|----------------|--|------------------|
| 40272          | Modbus NetID<br>Only for Modbus TCP protocol   | R/W              |
| 30301<br>40301 | Number of the digital input channels<br>Only for Modbus TCP protocol   | R                |
| 30311<br>40311 | Number of the digital output channels<br>Only for Modbus TCP protocol  | R                |
| 30321<br>40321 | Number of the analog input channels<br>Only for Modbus TCP protocol  | R                |
| 30331<br>40331 | Number of the analog output channels<br>Only for Modbus TCP protocol   | R                |
| 30352<br>40352 | Firmware version in hex format<br>Only for Modbus TCP protocol   | R                |
| 40449          | CO offset in 1ppm  | R/W              |
| 40450          | PM2.5 offset in 1 ug/m <sup>3</sup>  | R/W              |
| 40451          | Relative humidity offset in 0.01%  | R/W              |
| 40452          | Temperature offset in 0.01°C   | R/W              |
| 40456          | PM1.0 offset in 1 ug/m <sup>3</sup>  | R/W              |
| 40457          | PM10 offset in 1 ug/m <sup>3</sup>   | R/W              |
| 40481          | Firmware version (low word)  | R                |
| 40482          | Firmware version (high word)   | R                |
| 40483          | Module name (low word), 0x1021   | R                |
| 40484          | Module name (high word), 0x444C  | R                |
| 40485          | RS-485 module address, 1 to 247<br>Only for Modbus RTU protocol  | R/W              |
| 40486          | RS-485 baud rate and parity settings<br>Bits 5:0<br>Baud rate, valid range: 3 ~ 10<br>Bits 7:6<br>00: no parity, 1 stop bit<br>01: no parity, 2 stop bit<br>10: even parity, 1 stop bit<br>11: odd parity , 1 stop bit<br>Only for Modbus RTU protocol | R/W              |
| 40488          | RS-485 response delay time in ms, valid range, 0 ~ 30<br>Only for Modbus RTU protocol  | R/W              |

| <b>Address</b>                       | <b>Description</b>   | <b>Attribute</b> |
|--------------------------------------|--|------------------|
| 40489                                | RS-485 host watchdog timeout value, 0 ~ 255, in 0.1s<br>Only for Modbus RTU protocol                       | R/W              |
| 40492                                | RS-485 host watchdog timeout count, write 0 to clear<br>Only for Modbus RTU protocol                       | R/W              |
| 40497                                | Beep on alarm, 0: disable, 1 to 250: beep on alarm time in seconds, 251: beep on alarm continuously        | R/W              |
| 30513 ~<br>30527<br>40513 ~<br>40527 | High latched analog input value of channel 0 to 14   | R                |
| 30545 ~<br>30559<br>40545 ~<br>40559 | Low latched analog input value of channel 0 to 14  | R                |
| 30566<br>40566                       | Module reset status, 1: power-on, 2: watchdog, 3: software reset command<br>Only for Modbus TCP protocol   | R                |
| 40568                                | Ethernet host watchdog timeout value, 5 to 65535, in second, 0 to disable.<br>Only for Modbus TCP protocol | R/W              |
| 30569<br>40569                       | Ethernet host watchdog timeout count.<br>Only for Modbus TCP protocol                                      | R                |
| 30570<br>40570                       | Module name, 0x1021<br>Only for Modbus TCP protocol  | R                |
| 40564                                | TCP disconnection timeout value, 5 to 65535, in second, 0 to disable.<br>Only for Modbus TCP protocol      | R/W              |
| 40565                                | Module reset timeout value, 30 to 65535, in second, 0 to disable.<br>Only for Modbus TCP protocol          | R/W              |

| <b>Address</b> | <b>Description</b>  | <b>Attribute</b> |
|----------------|---|------------------|
| 40865          | RTC year, 2000 to 2159  | R/W              |
| 40866          | RTC month, 1 to 12  | R/W              |
| 40867          | RTC date, 1 to 31   | R/W              |
| 40868          | RTC hour, 0 to 23   | R/W              |
| 40869          | RTC minute, 0 to 59   | R/W              |
| 40870          | RTC second, 0 to 59   | R/W              |
| 40871          | Total number of log records, low word                           | R                |
| 40872          | Total number of log records, high word                          | R                |
| 40873          | The starting record to read log data, low word                  | R/W              |
| 40874          | The starting record to read log data, high word                 | R/W              |
| 40875          | The status of the data logging, 0: stopped, 1: running          | R                |
| 40876          | The data logger command, 0: stop, 1: run, 2: run in period mode | R/W              |
| 40877          | Continue writing when data logger is full, 0: no, 1: yes        | R/W              |
| 40878          | Hour of the data logger sampling period, 0 ~ 24                 | R/W              |
| 40879          | Minute of the data logger sampling period, 0 ~ 59               | R/W              |
| 40880          | Second of the data logger sampling period, 0 ~ 59               | R/W              |
| 40881          | Starting year when logging in period mode, 2000 ~ 2159          | R/W              |
| 40882          | Starting month when logging in period mode, 1 ~ 12              | R/W              |
| 40883          | Starting date when logging in period mode, 1 ~ 31               | R/W              |
| 40884          | Starting hour when logging in period mode, 0 ~ 23               | R/W              |
| 40885          | Starting minute when logging in period mode, 0 ~ 59             | R/W              |
| 40886          | Starting second when logging in period mode, 0 ~ 59             | R/W              |
| 40887          | Ending year when logging in period mode, 2000 ~ 2159            | R/W              |
| 40888          | Ending month when logging in period mode, 1 ~ 12                | R/W              |
| 40889          | Ending date when logging in period mode, 1 ~ 31                 | R/W              |
| 40890          | Ending hour when logging in period mode, 0 ~ 23                 | R/W              |

| <b>Address</b> | <b>Description</b>  | <b>Attribute</b> |
|----------------|---|------------------|
| 40891          | Ending minute when logging in period mode, 0 ~ 59                       | R/W              |
| 40892          | Ending second when logging in period mode, 0 ~ 59                       | R/W              |
| 40929          | The first fan off period in a day, beginning hour, 0 ~ 23               | R/W              |
| 40930          | The first fan off period in a day, beginning minute, 0 ~ 59             | R/W              |
| 40931          | The first fan off period in a day, ending hour, 0 ~ 23                  | R/W              |
| 40932          | The first fan off period in a day, ending minute, 0 ~ 59                | R/W              |
| 40933 ~ 40936  | The second fan off period in a day                                      | R/W              |
| 40937 ~ 40940  | The third fan off period in a day                                       | R/W              |
| 40941 ~ 40944  | The fourth fan off period in a day                                      | R/W              |
| 40945 ~ 40948  | The fifth fan off period in a day                                       | R/W              |
| 40949 ~ 40952  | The sixth fan off period in a day                                       | R/W              |
| 00001 ~ 00004  | Digital output value of channel 0 to 3                                  | R/W              |
| 00129 ~ 00132  | Safe value of digital output channel 0 to 3                             | R/W              |
| 00161 ~ 00164  | Power on value of digital output channel 0 to 3                         | R/W              |
| 00227          | Write 1 to reload default TCP settings<br>Only for Modbus TCP protocol  | W                |
| 00234          | Write 1 to reboot module<br>Only for Modbus TCP protocol                | W                |
| 00257          | RS-485 Protocol, 0: DCON, 1: Modbus RTU<br>Only for Modbus RTU protocol | R/W              |

| <b>Address</b> | <b>Description</b>   | <b>Attribute</b> |
|----------------|--|------------------|
| 00260          | Modbus RTU host watchdog mode<br>0: same as I-7000<br>1: can use AO and DO command to clear host watchdog timeout status<br>Only for Modbus RTU protocol | R/W              |
| 00261          | RS-485 host watchdog mode, 1: enable, 0: disable.<br>Only for Modbus RTU protocol  | R/W              |
| 00262          | Write 1 to play notification sound   | W                |
| 00270          | Host watch dog timeout status, write 1 to clear host watch dog timeout status<br>Only for Modbus RTU protocol  | R/W              |
| 00273          | Reset status, 1: first read after powered on, 0: not the first read after powered on<br>Only for Modbus RTU protocol                                     | R                |
| 00279          | Fan control, 0: off, 1: on   | R/W              |
| 00280          | Write 1 to clear all high latched analog input values  | W                |
| 00281          | Write 1 to clear all low latched analog input values   | W                |
| 00291 ~ 00295  | Low alarm status of channel 2 to 6. Write 1 to clear low latched alarm.  | R/W              |
| 00305 ~ 00319  | High alarm status of channel 0 to 14. Write 1 to clear high latched alarm.   | R/W              |
| 00321 ~ 00335  | Enable/disable alarm of channel 0 to 14  | R/W              |
| 00337 ~ 00351  | Alarm type, momentary or latched, of channel 0 to 14   | R/W              |
| 00385 ~ 00399  | Write 1 to clear high latched analog input value of channel 0 to 14  | W                |
| 00417 ~ 00431  | Write 1 to clear low latched analog input value of channel 0 to 14   | W                |
| 00449 ~ 00463  | Enable/disable beep on alarm for channel 0 to 14   | R/W              |

### C-3. DL-1022 Modbus Address Mappings (Base 1)

| Address                              | Description   | Attribute |
|--------------------------------------|---|-----------|
| 30001 ~<br>30015<br>40001 ~<br>40015 | Analog input value of channel 0 to 14. channel 0: CO <sub>2</sub> in 1ppm, channel 1: PM2.5 in 1ug/m <sup>3</sup> , channel 2: relative humidity in 0.01%, channel 3: temperature in 0.01°C, channel 4:temperature in 0.01°F, channel 5: dew point temperature in 0.01°C, channel 6: dew point temperature in 0.01°F, channel 7: PM1.0 in 1ug/m <sup>3</sup> , channel 8: PM10 in 1ug/m <sup>3</sup> , channel 9: particle count (0.3 - 0.5um), channel 10: particle count (0.5 - 1.0um), channel 11: particle count (1.0 - 2.5um), channel 12: particle count (2.5 - 5.0um), channel 13: particle count (5.0 - 7.5um), channel 14: particle count (7.5 - 10.0um) | R         |
| 40225 ~<br>40239                     | High alarm limit of channel 0 to 14, channel 0: CO <sub>2</sub> in 1ppm, channel 1: PM2.5 in 1ug/m <sup>3</sup> , channel 2: relative humidity in 0.01%, channel 3: temperature in 0.01°C, channel 4:temperature in 0.01°F, channel 5: dew point temperature in 0.01°C, channel 6: dew point temperature in 0.01°F, channel 7: PM1.0 in 1ug/m <sup>3</sup> , channel 8: PM10 in 1ug/m <sup>3</sup> , channel 9: particle count (0.3 - 0.5um), channel 10: particle count (0.5 - 1.0um), channel 11: particle count (1.0 - 2.5um), channel 12: particle count (2.5 - 5.0um), channel 13: particle count (5.0 - 7.5um), channel 14: particle count (7.5 - 10.0um)   | R/W       |
| 40243 ~<br>40247                     | Low alarm limit of channel 2 to 6, channel 2: relative humidity in 0.01%, channel 3: temperature in 0.01°C, channel 4:temperature in 0.01°F, channel 5: dew point temperature in 0.01°C, channel 6: dew point temperature in 0.01°F   | R/W       |
| 40272                                | Modbus NetID<br>Only for Modbus TCP protocol  | R/W       |



| <b>Address</b> | <b>Description</b>   | <b>Attribute</b> |
|----------------|--|------------------|
| 30301<br>40301 | Number of the digital input channels<br>Only for Modbus TCP protocol   | R                |
| 30311<br>40311 | Number of the digital output channels<br>Only for Modbus TCP protocol  | R                |
| 30321<br>40321 | Number of the analog input channels<br>Only for Modbus TCP protocol  | R                |
| 30331<br>40331 | Number of the analog output channels<br>Only for Modbus TCP protocol   | R                |
| 30352<br>40352 | Firmware version in hex format<br>Only for Modbus TCP protocol   | R                |
| 40449          | CO <sub>2</sub> offset in 1ppm   | R/W              |
| 40450          | PM2.5 offset in 1 ug/m <sup>3</sup>  | R/W              |
| 40451          | Relative humidity offset in 0.01%  | R/W              |
| 40452          | Temperature offset in 0.01°C   | R/W              |
| 40456          | PM1.0 offset in 1 ug/m <sup>3</sup>  | R/W              |
| 40457          | PM10 offset in 1 ug/m <sup>3</sup>   | R/W              |
| 40481          | Firmware version (low word)  | R                |
| 40482          | Firmware version (high word)   | R                |
| 40483          | Module name (low word), 0x1022   | R                |
| 40484          | Module name (high word), 0x444C  | R                |
| 40485          | RS-485 module address, 1 to 247<br>Only for Modbus RTU protocol  | R/W              |
| 40486          | RS-485 baud rate and parity settings<br>Bits 5:0<br>Baud rate, valid range: 3 ~ 10<br>Bits 7:6<br>00: no parity, 1 stop bit<br>01: no parity, 2 stop bit<br>10: even parity, 1 stop bit<br>11: odd parity , 1 stop bit<br>Only for Modbus RTU protocol | R/W              |
| 40488          | RS-485 response delay time in ms, valid range, 0 ~ 30<br>Only for Modbus RTU protocol  | R/W              |

| <b>Address</b>                 | <b>Description</b>   | <b>Attribute</b> |
|--------------------------------|--|------------------|
| 40489                          | RS-485 host watchdog timeout value, 0 ~ 255, in 0.1s<br>Only for Modbus RTU protocol                       | R/W              |
| 40492                          | RS-485 host watchdog timeout count, write 0 to clear<br>Only for Modbus RTU protocol                       | R/W              |
| 40496                          | Automatic baseline correction for CO <sub>2</sub> measurement, 0: disable, 1:enable                        | R/W              |
| 40497                          | Beep on alarm, 0: disable, 1 to 250: beep on alarm time in seconds, 251: beep on alarm continuously        | R/W              |
| 30513 ~ 30527<br>40513 ~ 40527 | High latched analog input value of channel 0 to 14   | R                |
| 30545 ~ 30559<br>40545 ~ 40559 | Low latched analog input value of channel 0 to 14  | R                |
| 30566<br>40566                 | Module reset status, 1: power-on, 2: watchdog, 3: software reset command<br>Only for Modbus TCP protocol   | R                |
| 40568                          | Ethernet host watchdog timeout value, 5 to 65535, in second, 0 to disable.<br>Only for Modbus TCP protocol | R/W              |
| 30569<br>40569                 | Ethernet host watchdog timeout count.<br>Only for Modbus TCP protocol                                      | R                |
| 30570<br>40570                 | Module name, 0x1022<br>Only for Modbus TCP protocol  | R                |
| 40564                          | TCP disconnection timeout value, 5 to 65535, in second, 0 to disable.<br>Only for Modbus TCP protocol      | R/W              |
| 40565                          | Module reset timeout value, 30 to 65535, in second, 0 to disable.<br>Only for Modbus TCP protocol          | R/W              |

| <b>Address</b> | <b>Description</b>  | <b>Attribute</b> |
|----------------|---|------------------|
| 40865          | RTC year, 2000 to 2159  | R/W              |
| 40866          | RTC month, 1 to 12  | R/W              |
| 40867          | RTC date, 1 to 31   | R/W              |
| 40868          | RTC hour, 0 to 23   | R/W              |
| 40869          | RTC minute, 0 to 59   | R/W              |
| 40870          | RTC second, 0 to 59   | R/W              |
| 40871          | Total number of log records, low word                           | R                |
| 40872          | Total number of log records, high word                          | R                |
| 40873          | The starting record to read log data, low word                  | R/W              |
| 40874          | The starting record to read log data, high word                 | R/W              |
| 40875          | The status of the data logging, 0: stopped, 1: running          | R                |
| 40876          | The data logger command, 0: stop, 1: run, 2: run in period mode | R/W              |
| 40877          | Continue writing when data logger is full, 0: no, 1: yes        | R/W              |
| 40878          | Hour of the data logger sampling period, 0 ~ 24                 | R/W              |
| 40879          | Minute of the data logger sampling period, 0 ~ 59               | R/W              |
| 40880          | Second of the data logger sampling period, 0 ~ 59               | R/W              |
| 40881          | Starting year when logging in period mode, 2000 ~ 2159          | R/W              |
| 40882          | Starting month when logging in period mode, 1 ~ 12              | R/W              |
| 40883          | Starting date when logging in period mode, 1 ~ 31               | R/W              |
| 40884          | Starting hour when logging in period mode, 0 ~ 23               | R/W              |
| 40885          | Starting minute when logging in period mode, 0 ~ 59             | R/W              |
| 40886          | Starting second when logging in period mode, 0 ~ 59             | R/W              |
| 40887          | Ending year when logging in period mode, 2000 ~ 2159            | R/W              |
| 40888          | Ending month when logging in period mode, 1 ~ 12                | R/W              |
| 40889          | Ending date when logging in period mode, 1 ~ 31                 | R/W              |
| 40890          | Ending hour when logging in period mode, 0 ~ 23                 | R/W              |

| <b>Address</b> | <b>Description</b>  | <b>Attribute</b> |
|----------------|---|------------------|
| 40891          | Ending minute when logging in period mode, 0 ~ 59                       | R/W              |
| 40892          | Ending second when logging in period mode, 0 ~ 59                       | R/W              |
| 40929          | The first fan off period in a day, beginning hour, 0 ~ 23               | R/W              |
| 40930          | The first fan off period in a day, beginning minute, 0 ~ 59             | R/W              |
| 40931          | The first fan off period in a day, ending hour, 0 ~ 23                  | R/W              |
| 40932          | The first fan off period in a day, ending minute, 0 ~ 59                | R/W              |
| 40933 ~ 40936  | The second fan off period in a day                                      | R/W              |
| 40937 ~ 40940  | The third fan off period in a day                                       | R/W              |
| 40941 ~ 40944  | The fourth fan off period in a day                                      | R/W              |
| 40945 ~ 40948  | The fifth fan off period in a day                                       | R/W              |
| 40949 ~ 40952  | The sixth fan off period in a day                                       | R/W              |
| 00001 ~ 00004  | Digital output value of channel 0 to 3                                  | R/W              |
| 00129 ~ 00132  | Safe value of digital output channel 0 to 3                             | R/W              |
| 00161 ~ 00164  | Power on value of digital output channel 0 to 3                         | R/W              |
| 00227          | Write 1 to reload default TCP settings<br>Only for Modbus TCP protocol  | W                |
| 00234          | Write 1 to reboot module<br>Only for Modbus TCP protocol                | W                |
| 00257          | RS-485 Protocol, 0: DCON, 1: Modbus RTU<br>Only for Modbus RTU protocol | R/W              |

| <b>Address</b> | <b>Description</b>   | <b>Attribute</b> |
|----------------|--|------------------|
| 00260          | Modbus RTU host watchdog mode<br>0: same as I-7000<br>1: can use AO and DO command to clear host watchdog timeout status<br>Only for Modbus RTU protocol | R/W              |
| 00261          | RS-485 host watchdog mode, 1: enable, 0: disable.<br>Only for Modbus RTU protocol  | R/W              |
| 00262          | Write 1 to play notification sound   | W                |
| 00270          | Host watch dog timeout status, write 1 to clear host watch dog timeout status<br>Only for Modbus RTU protocol  | R/W              |
| 00273          | Reset status, 1: first read after powered on, 0: not the first read after powered on<br>Only for Modbus RTU protocol                                     | R                |
| 00279          | Fan control, 0: off, 1: on   | R/W              |
| 00280          | Write 1 to clear all high latched analog input values  | W                |
| 00281          | Write 1 to clear all low latched analog input values   | W                |
| 00291 ~ 00295  | Low alarm status of channel 2 to 6. Write 1 to clear low latched alarm.  | R/W              |
| 00305 ~ 00319  | High alarm status of channel 0 to 14. Write 1 to clear high latched alarm.   | R/W              |
| 00321 ~ 00335  | Enable/disable alarm of channel 0 to 14  | R/W              |
| 00337 ~ 00351  | Alarm type, momentary or latched, of channel 0 to 14   | R/W              |
| 00385 ~ 00399  | Write 1 to clear high latched analog input value of channel 0 to 14  | W                |
| 00417 ~ 00431  | Write 1 to clear low latched analog input value of channel 0 to 14   | W                |
| 00449 ~ 00463  | Enable/disable beep on alarm for channel 0 to 14   | R/W              |

#### C-4. DL-1023 Modbus Address Mappings (Base 1)

| Address                              | Description  | Attribute |
|--------------------------------------|--|-----------|
| 30001 ~<br>30016<br>40001 ~<br>40016 | Analog input value of channel 0 to 15. channel 0: CO in 1ppm, channel 1: CO <sub>2</sub> in 1ppm, channel 2: PM2.5 in 1ug/m <sup>3</sup> , channel 3: relative humidity in 0.01%, channel 4: temperature in 0.01°C, channel 5: temperature in 0.01°F, channel 6: dew point temperature in 0.01°C, channel 7: dew point temperature in 0.01°F, channel 8: PM1.0 in 1ug/m <sup>3</sup> , channel 9: PM10 in 1ug/m <sup>3</sup> , channel 10: particle count (0.3 - 0.5um), channel 11: particle count (0.5 - 1.0um), channel 12: particle count (1.0 - 2.5um), channel 13: particle count (2.5 - 5.0um), channel 14: particle count (5.0 - 7.5um), channel 15: particle count (7.5 - 10.0um) | R         |
| 40225 ~<br>40240                     | High alarm limit of channel 0 to 15, channel 0: CO in 1ppm, channel 1: CO <sub>2</sub> in 1ppm, channel 2: PM2.5 in 1ug/m <sup>3</sup> , channel 3: relative humidity in 0.01%, channel 4: temperature in 0.01°C, channel 5: temperature in 0.01°F, channel 6: dew point temperature in 0.01°C, channel 7: dew point temperature in 0.01°F, channel 8: PM1.0 in 1ug/m <sup>3</sup> , channel 9: PM10 in 1ug/m <sup>3</sup> , channel 10: particle count (0.3 - 0.5um), channel 11: particle count (0.5 - 1.0um), channel 12: particle count (1.0 - 2.5um), channel 13: particle count (2.5 - 5.0um), channel 14: particle count (5.0 - 7.5um), channel 15: particle count (7.5 - 10.0um)   | R/W       |
| 40244 ~<br>40248                     | Low alarm limit of channel 3 to 7, channel 3: relative humidity in 0.01%, channel 4: temperature in 0.01°C, channel 5: temperature in 0.01°F, channel 6: dew point temperature in 0.01°C, channel 7: dew point temperature in 0.01°F   | R/W       |

| <b>Address</b> | <b>Description</b>   | <b>Attribute</b> |
|----------------|--|------------------|
| 40272          | Modbus NetID<br>Only for Modbus TCP protocol   | R/W              |
| 30301<br>40301 | Number of the digital input channels<br>Only for Modbus TCP protocol   | R                |
| 30311<br>40311 | Number of the digital output channels<br>Only for Modbus TCP protocol  | R                |
| 30321<br>40321 | Number of the analog input channels<br>Only for Modbus TCP protocol  | R                |
| 30331<br>40331 | Number of the analog output channels<br>Only for Modbus TCP protocol   | R                |
| 30352<br>40352 | Firmware version in hex format<br>Only for Modbus TCP protocol   | R                |
| 40449          | CO offset in 1ppm  | R/W              |
| 40450          | CO <sub>2</sub> offset in 1ppm   | R/W              |
| 40451          | PM2.5 offset in 1 ug/m <sup>3</sup>  | R/W              |
| 40452          | Relative humidity offset in 0.01%  | R/W              |
| 40453          | Temperature offset in 0.01°C   | R/W              |
| 40457          | PM1.0 offset in 1 ug/m <sup>3</sup>  | R/W              |
| 40458          | PM10 offset in 1 ug/m <sup>3</sup>   | R/W              |
| 40481          | Firmware version (low word)  | R                |
| 40482          | Firmware version (high word)   | R                |
| 40483          | Module name (low word), 0x1023   | R                |
| 40484          | Module name (high word), 0x444C  | R                |
| 40485          | RS-485 module address, 1 to 247<br>Only for Modbus RTU protocol  | R/W              |
| 40486          | RS-485 baud rate and parity settings<br>Bits 5:0<br>Baud rate, valid range: 3 ~ 10<br>Bits 7:6<br>00: no parity, 1 stop bit<br>01: no parity, 2 stop bit<br>10: even parity, 1 stop bit<br>11: odd parity , 1 stop bit<br>Only for Modbus RTU protocol | R/W              |

| <b>Address</b>                 | <b>Description</b>   | <b>Attribute</b> |
|--------------------------------|--|------------------|
| 40488                          | RS-485 response delay time in ms, valid range, 0 ~ 30<br>Only for Modbus RTU protocol                      | R/W              |
| 40489                          | RS-485 host watchdog timeout value, 0 ~ 255, in 0.1s<br>Only for Modbus RTU protocol                       | R/W              |
| 40492                          | RS-485 host watchdog timeout count, write 0 to clear<br>Only for Modbus RTU protocol                       | R/W              |
| 40496                          | Automatic baseline correction for CO <sub>2</sub> measurement, 0: disable, 1:enable                        | R/W              |
| 40497                          | Beep on alarm, 0: disable, 1 to 250: beep on alarm time in seconds, 251: beep on alarm continuously        | R/W              |
| 30513 ~ 30528<br>40513 ~ 40528 | High latched analog input value of channel 0 to 15   | R                |
| 30545 ~ 30560<br>40545 ~ 40560 | Low latched analog input value of channel 0 to 15  | R                |
| 30566<br>40566                 | Module reset status, 1: power-on, 2: watchdog, 3: software reset command<br>Only for Modbus TCP protocol   | R                |
| 40568                          | Ethernet host watchdog timeout value, 5 to 65535, in second, 0 to disable.<br>Only for Modbus TCP protocol | R/W              |
| 30569<br>40569                 | Ethernet host watchdog timeout count.<br>Only for Modbus TCP protocol                                      | R                |
| 30570<br>40570                 | Module name, 0x1023<br>Only for Modbus TCP protocol  | R                |
| 40564                          | TCP disconnection timeout value, 5 to 65535, in second, 0 to disable.<br>Only for Modbus TCP protocol      | R/W              |



| <b>Address</b> | <b>Description</b>  | <b>Attribute</b> |
|----------------|---|------------------|
| 40565          | Module reset timeout value, 30 to 65535, in second, 0 to disable.<br>Only for Modbus TCP protocol | R/W              |
| 40865          | RTC year, 2000 to 2159  | R/W              |
| 40866          | RTC month, 1 to 12  | R/W              |
| 40867          | RTC date, 1 to 31   | R/W              |
| 40868          | RTC hour, 0 to 23   | R/W              |
| 40869          | RTC minute, 0 to 59   | R/W              |
| 40870          | RTC second, 0 to 59   | R/W              |
| 40871          | Total number of log records, low word   | R                |
| 40872          | Total number of log records, high word  | R                |
| 40873          | The starting record to read log data, low word  | R/W              |
| 40874          | The starting record to read log data, high word   | R/W              |
| 40875          | The status of the data logging, 0: stopped, 1: running  | R                |
| 40876          | The data logger command, 0: stop, 1: run, 2: run in period mode                                   | R/W              |
| 40877          | Continue writing when data logger is full, 0: no, 1: yes  | R/W              |
| 40878          | Hour of the data logger sampling period, 0 ~ 24   | R/W              |
| 40879          | Minute of the data logger sampling period, 0 ~ 59   | R/W              |
| 40880          | Second of the data logger sampling period, 0 ~ 59   | R/W              |
| 40881          | Starting year when logging in period mode, 2000 ~ 2159  | R/W              |
| 40882          | Starting month when logging in period mode, 1 ~ 12  | R/W              |
| 40883          | Starting date when logging in period mode, 1 ~ 31   | R/W              |
| 40884          | Starting hour when logging in period mode, 0 ~ 23   | R/W              |
| 40885          | Starting minute when logging in period mode, 0 ~ 59   | R/W              |
| 40886          | Starting second when logging in period mode, 0 ~ 59   | R/W              |
| 40887          | Ending year when logging in period mode, 2000 ~ 2159  | R/W              |
| 40888          | Ending month when logging in period mode, 1 ~ 12  | R/W              |

| <b>Address</b> | <b>Description</b>   | <b>Attribute</b> |
|----------------|--|------------------|
| 40889          | Ending date when logging in period mode, 1 ~ 31                        | R/W              |
| 40890          | Ending hour when logging in period mode, 0 ~ 23                        | R/W              |
| 40891          | Ending minute when logging in period mode, 0 ~ 59                      | R/W              |
| 40892          | Ending second when logging in period mode, 0 ~ 59                      | R/W              |
| 40929          | The first fan off period in a day, beginning hour, 0 ~ 23              | R/W              |
| 40930          | The first fan off period in a day, beginning minute, 0 ~ 59            | R/W              |
| 40931          | The first fan off period in a day, ending hour, 0 ~ 23                 | R/W              |
| 40932          | The first fan off period in a day, ending minute, 0 ~ 59               | R/W              |
| 40933 ~ 40936  | The second fan off period in a day                                     | R/W              |
| 40937 ~ 40940  | The third fan off period in a day                                      | R/W              |
| 40941 ~ 40944  | The fourth fan off period in a day                                     | R/W              |
| 40945 ~ 40948  | The fifth fan off period in a day                                      | R/W              |
| 40949 ~ 40952  | The sixth fan off period in a day                                      | R/W              |
| 00001 ~ 00004  | Digital output value of channel 0 to 3                                 | R/W              |
| 00129 ~ 00132  | Safe value of digital output channel 0 to 3                            | R/W              |
| 00161 ~ 00164  | Power on value of digital output channel 0 to 3                        | R/W              |
| 00227          | Write 1 to reload default TCP settings<br>Only for Modbus TCP protocol | W                |
| 00234          | Write 1 to reboot module<br>Only for Modbus TCP protocol               | W                |

| <b>Address</b>   | <b>Description</b>  | <b>Attribute</b> |
|------------------|---|------------------|
| 00257            | RS-485 Protocol, 0: DCON, 1: Modbus RTU<br>Only for Modbus RTU protocol   | R/W              |
| 00260            | Modbus RTU host watchdog mode<br>0: same as I-7000<br>1: can use AO and DO command to clear host<br>watchdog timeout status<br>Only for Modbus RTU protocol | R/W              |
| 00261            | RS-485 host watchdog mode, 1: enable, 0: disable.<br>Only for Modbus RTU protocol   | R/W              |
| 00262            | Write 1 to play notification sound  | W                |
| 00270            | Host watch dog timeout status, write 1 to clear host<br>watch dog timeout status<br>Only for Modbus RTU protocol  | R/W              |
| 00273            | Reset status, 1: first read after powered on, 0: not<br>the first read after powered on<br>Only for Modbus RTU protocol                                     | R                |
| 00279            | Fan control, 0: off, 1: on  | R/W              |
| 00280            | Write 1 to clear all high latched analog input values   | W                |
| 00281            | Write 1 to clear all low latched analog input values  | W                |
| 00292 ~<br>00296 | Low alarm status of channel 3 to 7. Write 1 to clear<br>low latched alarm.  | R/W              |
| 00305 ~<br>00320 | High alarm status of channel 0 to 15. Write 1 to<br>clear high latched alarm.   | R/W              |
| 00321 ~<br>00336 | Enable/disable alarm of channel 0 to 15   | R/W              |
| 00337 ~<br>00352 | Alarm type, momentary or latched, of channel 0 to<br>15   | R/W              |
| 00385 ~<br>00400 | Write 1 to clear high latched analog input value of<br>channel 0 to 15  | W                |
| 00417 ~<br>00432 | Write 1 to clear low latched analog input value of<br>channel 0 to 15   | W                |
| 00449 ~<br>00464 | Enable/disable beep on alarm for channel 0 to 15  | R/W              |

### C-5. DL-1038 Modbus Address Mappings (Base 1)

| Address                              | Description   | Attribute |
|--------------------------------------|---|-----------|
| 30001 ~<br>30017<br>40001 ~<br>40017 | Analog input value of channel 0 to 16. channel 0: CO in 1ppm, channel 1: CO <sub>2</sub> in 1ppm, channel 2: TVOC in 1ppb, channel 3: PM2.5 in 1ug/m <sup>3</sup> , channel 4: relative humidity in 0.01%, channel 5: temperature in 0.01°C, channel 6:temperature in 0.01°F, channel 7: dew point temperature in 0.01°C, channel 8: dew point temperature in 0.01°F, channel 9: PM1.0 in 1ug/m <sup>3</sup> , channel 10: PM10 in 1ug/m <sup>3</sup> , channel 11: particle count (0.3 - 0.5um), channel 12: particle count (0.5 - 1.0um), channel 13: particle count (1.0 - 2.5um), channel 14: particle count (2.5 - 5.0um), channel 15: particle count (5.0 - 7.5um), channel 16: particle count (7.5 - 10.0um) | R         |
| 40225 ~<br>40241                     | High alarm limit of channel 0 to 16, channel 0: CO in 1ppm, channel 1: CO <sub>2</sub> in 1ppm, channel 2: TVOC in 1ppb, channel 3: PM2.5 in 1ug/m <sup>3</sup> , channel 4: relative humidity in 0.01%, channel 5: temperature in 0.01°C, channel 6:temperature in 0.01°F, channel 7: dew point temperature in 0.01°C, channel 8: dew point temperature in 0.01°F, channel 9: PM1.0 in 1ug/m <sup>3</sup> , channel 10: PM10 in 1ug/m <sup>3</sup> , channel 11: particle count (0.3 - 0.5um), channel 12: particle count (0.5 - 1.0um), channel 13: particle count (1.0 - 2.5um), channel 14: particle count (2.5 - 5.0um), channel 15: particle count (5.0 - 7.5um), channel 16: particle count (7.5 - 10.0um)   | R/W       |
| 40261 ~<br>40265                     | Low alarm limit of channel 4 to 8, channel 4: relative humidity in 0.01%, channel 5: temperature in 0.01°C, channel 6:temperature in 0.01°F, channel 7: dew point temperature in 0.01°C, channel 8: dew point temperature in 0.01°F   | R/W       |

| <b>Address</b> | <b>Description</b>   | <b>Attribute</b> |
|----------------|--|------------------|
| 30301<br>40301 | Number of the digital input channels<br>Only for Modbus TCP protocol   | R                |
| 30311<br>40311 | Number of the digital output channels<br>Only for Modbus TCP protocol  | R                |
| 30321<br>40321 | Number of the analog input channels<br>Only for Modbus TCP protocol  | R                |
| 30331<br>40331 | Number of the analog output channels<br>Only for Modbus TCP protocol   | R                |
| 30352<br>40352 | Firmware version in hex format<br>Only for Modbus TCP protocol   | R                |
| 40372          | Modbus NetID<br>Only for Modbus TCP protocol   | R/W              |
| 40449          | CO offset in 1ppm  | R/W              |
| 40450          | CO <sub>2</sub> offset in 1ppm   | R/W              |
| 40451          | TVOC offset in 1ppb  | R/W              |
| 40452          | PM2.5 offset in 1 ug/m <sup>3</sup>  | R/W              |
| 40453          | Relative humidity offset in 0.01%  | R/W              |
| 40454          | Temperature offset in 0.01°C   | R/W              |
| 40458          | PM1.0 offset in 1 ug/m <sup>3</sup>  | R/W              |
| 40459          | PM10 offset in 1 ug/m <sup>3</sup>   | R/W              |
| 40481          | Firmware version (low word)  | R                |
| 40482          | Firmware version (high word)   | R                |
| 40483          | Module name (low word), 0x1038   | R                |
| 40484          | Module name (high word), 0x444C  | R                |
| 40485          | RS-485 module address, 1 to 247<br>Only for Modbus RTU protocol  | R/W              |
| 40486          | RS-485 baud rate and parity settings<br>Bits 5:0<br>Baud rate, valid range: 3 ~ 10<br>Bits 7:6<br>00: no parity, 1 stop bit<br>01: no parity, 2 stop bit<br>10: even parity, 1 stop bit<br>11: odd parity , 1 stop bit<br>Only for Modbus RTU protocol | R/W              |

| <b>Address</b>                       | <b>Description</b>   | <b>Attribute</b> |
|--------------------------------------|--|------------------|
| 40488                                | RS-485 response delay time in ms, valid range, 0 ~ 30<br>Only for Modbus RTU protocol                      | R/W              |
| 40489                                | RS-485 host watchdog timeout value, 0 ~ 255, in 0.1s<br>Only for Modbus RTU protocol                       | R/W              |
| 40492                                | RS-485 host watchdog timeout count, write 0 to clear<br>Only for Modbus RTU protocol                       | R/W              |
| 40496                                | Automatic baseline correction for CO <sub>2</sub> measurement, 0: disable, 1:enable                        | R/W              |
| 40497                                | Beep on alarm, 0: disable, 1 to 250: beep on alarm time in seconds, 251: beep on alarm continuously        | R/W              |
| 30513 ~<br>30529<br>40513 ~<br>40529 | High latched analog input value of channel 0 to 16   | R                |
| 30545 ~<br>30561<br>40545 ~<br>40561 | Low latched analog input value of channel 0 to 16  | R                |
| 40564                                | TCP disconnection timeout value, 5 to 65535, in second, 0 to disable.<br>Only for Modbus TCP protocol      | R/W              |
| 40565                                | Module reset timeout value, 30 to 65535, in second, 0 to disable.<br>Only for Modbus TCP protocol          | R/W              |
| 30566<br>40566                       | Module reset status, 1: power-on, 2: watchdog, 3: software reset command<br>Only for Modbus TCP protocol   | R                |
| 40568                                | Ethernet host watchdog timeout value, 5 to 65535, in second, 0 to disable.<br>Only for Modbus TCP protocol | R/W              |
| 30569<br>40569                       | Ethernet host watchdog timeout count.<br>Only for Modbus TCP protocol                                      | R                |

| <b>Address</b> | <b>Description</b>  | <b>Attribute</b> |
|----------------|---|------------------|
| 30570          | Module name, 0x1038   | R                |
| 40570          | Only for Modbus TCP protocol                                    |                  |
| 40865          | RTC year, 2000 to 2159  | R/W              |
| 40866          | RTC month, 1 to 12  | R/W              |
| 40867          | RTC date, 1 to 31   | R/W              |
| 40868          | RTC hour, 0 to 23   | R/W              |
| 40869          | RTC minute, 0 to 59   | R/W              |
| 40870          | RTC second, 0 to 59   | R/W              |
| 40871          | Total number of log records, low word                           | R                |
| 40872          | Total number of log records, high word                          | R                |
| 40873          | The starting record to read log data, low word                  | R/W              |
| 40874          | The starting record to read log data, high word                 | R/W              |
| 40875          | The status of the data logging, 0: stopped, 1: running          | R                |
| 40876          | The data logger command, 0: stop, 1: run, 2: run in period mode | R/W              |
| 40877          | Continue writing when data logger is full, 0: no, 1: yes        | R/W              |
| 40878          | Hour of the data logger sampling period, 0 ~ 24                 | R/W              |
| 40879          | Minute of the data logger sampling period, 0 ~ 59               | R/W              |
| 40880          | Second of the data logger sampling period, 0 ~ 59               | R/W              |
| 40881          | Starting year when logging in period mode, 2000 ~ 2159          | R/W              |
| 40882          | Starting month when logging in period mode, 1 ~ 12              | R/W              |
| 40883          | Starting date when logging in period mode, 1 ~ 31               | R/W              |
| 40884          | Starting hour when logging in period mode, 0 ~ 23               | R/W              |
| 40885          | Starting minute when logging in period mode, 0 ~ 59             | R/W              |
| 40886          | Starting second when logging in period mode, 0 ~ 59             | R/W              |
| 40887          | Ending year when logging in period mode, 2000 ~ 2159            | R/W              |
| 40888          | Ending month when logging in period mode, 1 ~ 12                | R/W              |

| <b>Address</b> | <b>Description</b>  | <b>Attribute</b> |
|----------------|---|------------------|
| 40889          | Ending date when logging in period mode, 1 ~ 31             | R/W              |
| 40890          | Ending hour when logging in period mode, 0 ~ 23             | R/W              |
| 40891          | Ending minute when logging in period mode, 0 ~ 59           | R/W              |
| 40892          | Ending second when logging in period mode, 0 ~ 59           | R/W              |
| 40929          | The first fan off period in a day, beginning hour, 0 ~ 23   | R/W              |
| 40930          | The first fan off period in a day, beginning minute, 0 ~ 59 | R/W              |
| 40931          | The first fan off period in a day, ending hour, 0 ~ 23      | R/W              |
| 40932          | The first fan off period in a day, ending minute, 0 ~ 59    | R/W              |
| 40933 ~ 40936  | The second fan off period in a day                          | R/W              |
| 40937 ~ 40940  | The third fan off period in a day                           | R/W              |
| 40941 ~ 40944  | The fourth fan off period in a day                          | R/W              |
| 40945 ~ 40948  | The fifth fan off period in a day                           | R/W              |
| 40949 ~ 40952  | The sixth fan off period in a day                           | R/W              |



## Revision History

| Revision | Date     | Description                |
|----------|----------|----------------------------|
| 1.0.0    | 2020/ 05 | First released             |
| 1.1.0    | 2020/ 08 | -Added DL-1038 information |